

2023



Zevo 600 Owner's Manual



Contents

Introduction	1
Keys, Doors, and Windows	6
Seats and Restraints	25
Storage	46
Instruments and Controls	50
Lighting	76
Infotainment System	83
Climate Controls	105
Driving and Operating	109
Vehicle Care	169
Service and Maintenance	228
Technical Data	235
Customer Information	237
Reporting Safety Defects	238
OnStar	240
Index	245

Introduction California Proposition 65 Warning



WARNING

Operating, servicing and maintaining a passenger vehicle or off-highway motor vehicle can expose you to chemicals including engine exhaust, carbon monoxide, phthalates, and lead, which are known to the State of California to cause cancer and birth defects or other reproductive harm. To minimize exposure, avoid breathing exhaust, do not idle engine except as necessary, service your vehicle in a well-ventilated area and wear gloves or wash your hands frequently when servicing your vehicle. For more information go to www.P65Warnings.ca.gov/passenger-vehicle.

Introduction



The names, logos, emblems, slogans, vehicle model names, and vehicle body designs appearing in this manual including, but not limited to, BrightDrop and EV600, are trademarks and/or service marks of General Motors LLC, its subsidiaries, affiliates, or licensors.

For vehicles first sold in Canada, substitute the name “General Motors of Canada Company” for BrightDrop wherever it appears in this manual.

This manual describes features that may or may not be on the vehicle because of optional equipment that was not purchased on the vehicle, model variants, country specifications, features/applications that may not be available in your region, or changes subsequent to the printing of this owner’s manual, including changes in standard or optional content.

Refer to the purchase documentation relating to your specific vehicle to confirm the features.

Keep this manual in the vehicle for quick reference.

Canadian Vehicle Owners

A French language manual can be obtained from your dealer, at www.helminc.com, or from:

Propriétaires Canadiens

On peut obtenir un exemplaire de ce guide en français auprès du concessionnaire ou à l'adresse suivante:

Helm, Incorporated
Attention: Customer Service
47911 Halyard Drive
Plymouth, MI 48170
USA

Using this Manual

To quickly locate information about the vehicle, use the Index in the back of the manual. It is an alphabetical list of what is in the manual and the page number where it can be found.

Danger, Warning, and Caution

Warning messages found on vehicle labels and in this manual describe hazards and what to do to avoid or reduce them.

Danger

Danger indicates a hazard with a high level of risk which will result in serious injury or death.

Warning

Warning indicates a hazard that could result in injury or death.

Caution

Caution indicates a hazard that could result in property or vehicle damage.





A circle with a slash through it is a safety symbol which means “Do not,” “Do not do this,” or “Do not let this happen.”

Symbols

The vehicle has components and labels that use symbols instead of text. Symbols are shown along with the text describing the operation or information relating to a specific component, control, message, gauge, or indicator.

 : Shown when the owner’s manual has additional instructions or information.

 : Shown when the service manual has additional instructions or information.

 : Shown when there is more information on another page — “see page.”

Vehicle Symbol Chart

Here are some additional symbols that may be found on the vehicle and what they mean. See the features in this manual for information.

 : Air Conditioning System

 : Air Conditioning Refrigerant Oil

 : Airbag Readiness Light

 : Antilock Brake System (ABS)

 : Brake System Warning Light

 : Dispose of Used Components Properly

 : Do Not Apply High Pressure Water

 : Energy Usage and Charge Mode Selection

 : Flame/Fire Prohibited

 : Flammable

 : First Responder

 : Forward Collision Alert

 : Fuse Block Cover Lock Location

 : Fuses

 : High Voltage

 : ISOFIX/LATCH System Child Restraints

 : Keep Fuse Block Covers Properly Installed

 : Lane Change Alert

 : Lane Departure Warning

 : Lane Keep Assist

 : Park Assist

 : Pedestrian Ahead Indicator

 : Power

 : Rear Cross Traffic Alert

 : Registered Technician

 : Remote Vehicle Start

 : Risk of Electrical Fire

 : Seat Belt Reminders

 : Service Vehicle Soon

 : Side Blind Zone Alert

 : Tire Pressure Monitor

 : Traction Control/StabiliTrak/Electronic Stability Control (ESC)

 : Under Pressure

 : Vehicle Ahead Indicator

 : Vehicle Ready

Instrument Panel Overview

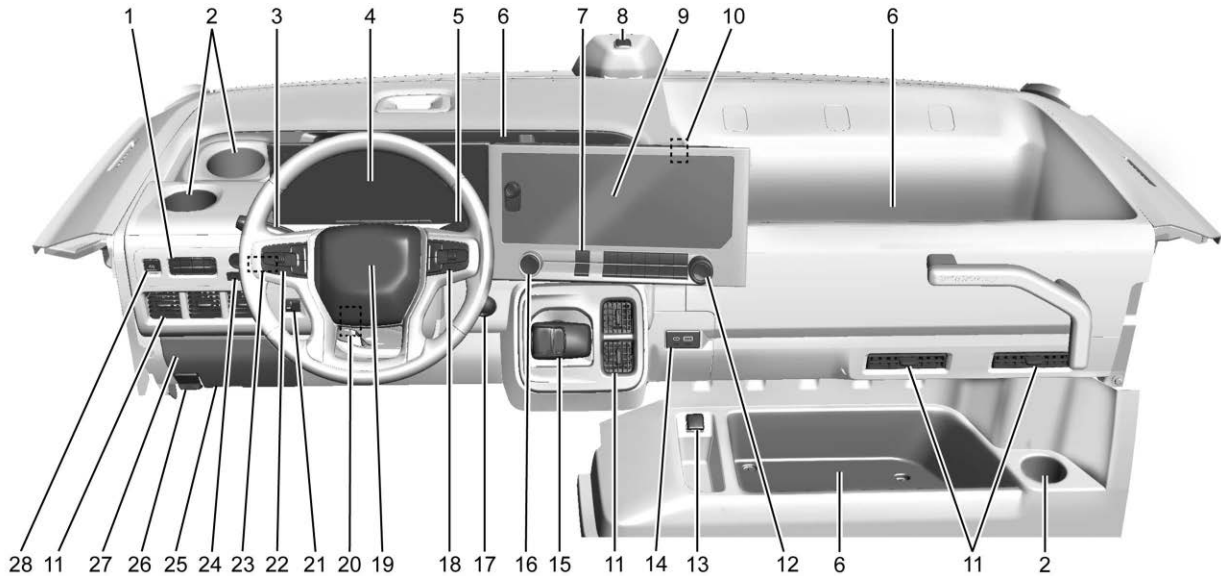

1. Delivery Mode.
Lane Keep Assist (LKA) ⇨ 158.
Door Lock Button. See *Power Door Locks* ⇨ 14.
Park Assist ⇨ 148.
Exterior Cargo Lamps ⇨ 79.
Door Unlock Button. See *Power Door Locks* ⇨ 14.
Cargo Lamps ⇨ 80.
Cab Dome Lamp. See *Dome Lamps* ⇨ 80.
2. *Cupholders* ⇨ 47.
3. Turn Signal Lever. See *Turn and Lane-Change Signals* ⇨ 79.
Exterior Lamp Controls ⇨ 76.
4. *Instrument Cluster* ⇨ 55.
5. *Windshield Wiper/Washer* ⇨ 52.
6. *Instrument Panel Storage* ⇨ 46.
7. 360° Camera. See *Surround Vision System* ⇨ 146.
Heated Mirrors ⇨ 23.
8. Light Sensor. See *Automatic Headlamp System* ⇨ 78.
9. Infotainment. See *Introduction* ⇨ 83.
10. 110 Volt Power Outlet (Out of View). See *Power Outlets* ⇨ 54.
11. *Air Vents* ⇨ 107.
12. *Automatic Climate Control System* ⇨ 105.
Heated Front Seats ⇨ 28.
13. 12 Volt Power Outlet. See *Power Outlets* ⇨ 54.
14. *USB Port* ⇨ 89.
15. Shift Lever. See *Electric Drive Unit* ⇨ 124.
16. *Hazard Warning Flashers* ⇨ 79.
17. *Power Button* ⇨ 121.
18. *Steering Wheel Controls* ⇨ 85.
19. *Horn* ⇨ 51.
20. *Steering Wheel Adjustment* ⇨ 51 (Out of View).
21. *Instrument Panel Illumination Control* ⇨ 80.
22. *Cruise Control* ⇨ 133.
Forward Collision Alert (FCA) System ⇨ 151.
Heated Steering Wheel ⇨ 51.
23. Window Controls Switches (Out of View).
24. Mirror Adjustment Buttons.
25. Data Link Connector (DLC) (Out of View). See *Service Vehicle Soon Light (Propulsion System Failure)* ⇨ 61.
26. Hood Release. See *Hood* ⇨ 171.
27. *Instrument Panel Fuse Block* ⇨ 187.
28. *Electric Parking Brake* ⇨ 129.

Keys, Doors, and Windows

Keys and Locks

Keys	6
Remote Key	7
Remote Key Operation	7
Remote Vehicle Start	13
Door Locks	13
Power Door Locks	14
Delayed Locking	15
Automatic Door Locks	15
Lockout Protection	15

Doors

Sliding Door (Bulkhead Door)	16
Rear Doors (Exterior)	17

Vehicle Security

Vehicle Security	20
Vehicle Alarm System	20
Steering Column Lock	21
Immobilizer	21
Immobilizer Operation	21

Exterior Mirrors

Convex Mirrors	22
Power Mirrors	22
Folding Mirrors	23
Heated Mirrors	23

Windows

Windows	23
Power Windows	23
Sun Visors	24

Keys and Locks

Keys

Warning

Leaving children in a vehicle with a remote key is dangerous and children or others could be seriously injured or killed. They could operate the power windows or other controls or make the vehicle move. The windows will function with the remote key in the vehicle, and children or others could be caught in the path of a closing window. Do not leave children in a vehicle with a remote key.





The mechanical key inside the remote key is used for the rear sliding door.

Press the button on the side of the remote key, near the bottom, and pull the mechanical key out. Never pull the mechanical key out without pressing the button.

The mechanical key may have a bar-coded key tag that the dealer or qualified locksmith can use to make new keys. Store this information in a safe place, not in the vehicle.

See your dealer if a replacement key or additional key is needed.

If it becomes difficult to turn a key, inspect the key blade for debris. Periodically clean with a brush or pick.

With an active OnStar or connected service plan, an OnStar Advisor may remotely unlock the vehicle. See *OnStar Overview* ⇨ 240.

Remote Key

See *Radio Frequency Statement* ⇨ 237.

If there is a decrease in the remote key operating range:

- Check the distance. The remote key may be too far from the vehicle.
- Check the location. Other vehicles or objects may be blocking the signal.
- Check the remote key's battery. See "Battery Replacement" later in this section.
- If the remote key is still not working correctly, see your dealer or a qualified technician for service.

Remote Key Operation

The Keyless Access system allows for vehicle entry when the remote key is within 1 m (3 ft). See "Keyless Access Operation" later in this section.

The remote key functions may work up to 60 m (197 ft) away from the vehicle.

Other conditions can affect the performance of the remote key. See *Remote Key* ⇨ 7.





 : Press to lock all doors.

If enabled, the turn signal lamps flash once on the second press to indicate locking has occurred. If enabled, the horn chirps when  is pressed again within three seconds. To view available settings from the infotainment screen, touch Settings > Vehicle > Remote Lock, Unlock, Start.

Pressing  arms the alarm system. See *Vehicle Alarm System* ⇨ 20.

8 Keys, Doors, and Windows

If equipped with auto mirror folding, double pressing and holding  for one second will fold the mirrors, if enabled. To view available settings from the infotainment screen, touch Settings > Vehicle > Comfort and Convenience.

 : Press once to unlock only the driver door. If  is pressed again within three seconds, all remaining doors unlock. The interior lamps may come on and stay on for 20 seconds or until the vehicle is turned on.



If enabled, the turn signal lamps flash twice to indicate unlocking has occurred. If enabled, the exterior lamps may turn on. To view available settings from the infotainment screen, touch Settings > Vehicle > Remote Lock, Unlock, Start.



Pressing  on the remote key disarms the alarm system. See *Vehicle Alarm System* ⇨ 20.

If equipped with auto mirror folding, double pressing and holding  for one second will unfold the mirrors, if enabled. To view available settings from the infotainment screen, touch Settings > Vehicle > Comfort and Convenience.

Double press and hold  until the windows fully open, if remote window operation is enabled. To view available settings from the infotainment screen, touch Settings > Vehicle > Remote Lock, Unlock, Start.

 : Press and release to initiate vehicle locate. The turn signal lamps flash and the horn sounds three times.

Press and hold  for more than three seconds to activate the panic alarm. The turn signal lamps flash and the horn sounds repeatedly for 30 seconds. The alarm turns off when the vehicle is turned on or  is pressed again. The vehicle must be off for the panic alarm to work.

 : To remote start the vehicle, double press  from outside the vehicle using the remote key. The vehicle cannot be started if a remote key is left inside the vehicle. See *Remote Vehicle Start* ⇨ 13.

Keyless Access Operation

The Keyless Access system allows for exterior doors and the rear sliding door to be accessed without removing the remote key from your pocket, purse, briefcase, etc. The remote key must be within 1 m (3 ft) of

the rear sliding door or exterior door being opened. If the vehicle has this feature, there will be a button on the outside touchpads.

Keyless Access can be programmed to unlock all doors on the first lock/unlock press from the driver door. To view available settings from the infotainment screen, touch Settings > Vehicle > Remote Lock, Unlock, Start.

Keyless Unlocking/Locking from the Driver Door

When the doors are locked and the remote key is within 1 m (3 ft) of the door handle, pressing the lock/unlock button on the driver door touchpad will unlock the driver door. If the lock/unlock button is pressed again within five seconds, the doors and rear sliding door will unlock.



Driver Side Shown, Passenger Side Similar

Pressing the lock/unlock button will cause all doors to lock if any of the following occur:

- It has been more than five seconds since the first lock/unlock button press.
- Two lock/unlock button presses were used to unlock all doors.
- Any vehicle door has been opened and all doors are now closed.

Keyless Unlocking/Locking from the Passenger Doors

When the doors are locked and the remote key is within 1 m (3 ft) of the door handle, pressing the lock/unlock button on a passenger door touchpad will unlock all



doors. Pressing the lock/unlock button will cause all doors to lock if any of the following occur:

- The lock/unlock button was used to unlock all doors.
- Any vehicle door has been opened and all doors are now closed.



Disable/Enable Keyless Unlocking of Exterior Door Handles and Rear Sliding Door

If equipped, keyless unlocking of the exterior door handles and rear sliding door can be disabled and enabled.

Disabling Keyless Unlocking:

With the vehicle off, press and hold  and  on the remote key at the same time for approximately three seconds. The turn signal lamps will flash four times quickly to indicate access is disabled. Using any exterior handle to unlock the doors or open the rear sliding door will cause the turn signal lamps to flash four times quickly, indicating access is disabled. If disabled, disarm the alarm system before starting the vehicle.

Enabling Keyless Unlocking:

With the vehicle off, press and hold  and  on the remote key at the same time for approximately three seconds. The turn signal lamps will flash twice quickly to indicate access is enabled.

To view available settings from the infotainment screen, touch Settings > Vehicle > Remote Lock, Unlock, Start.



Passive Locking

The Keyless Access system will lock the vehicle several seconds after all doors are closed, if the vehicle is off and at least one remote key has been removed from the interior, or none remain in the interior.

If other electronic devices interfere with the remote key signal, the vehicle may not detect the remote key inside the vehicle. If passive locking is enabled, the doors may lock with the remote key inside the vehicle. Do not leave the remote key in an unattended vehicle.

To view available settings from the infotainment screen, touch Settings > Vehicle > Remote Lock, Unlock, Start.

Temporary Disable of Passive Locking

Temporarily disable passive locking by pressing and holding  on the interior door switch with a door open for at least four seconds, or until three chimes are heard. Passive locking will then remain disabled until  on the interior door is pressed, or until the vehicle is turned on.

Remote Left In Vehicle Alert

When the vehicle is turned off and a remote key is left in the vehicle, the horn will chirp three times after all doors are closed. To view available settings from the infotainment screen, touch Settings > Vehicle > Remote Lock, Unlock, Start.

Remote Removed From Vehicle Alert

If the vehicle is on with a door open, and then all doors are closed, the vehicle will check for remote keys inside. If a remote key is not detected, the Driver Information Center (DIC) will display NO KEY FOUND and the horn will chirp three times. This occurs only once each time the vehicle is driven. To view available settings from the infotainment screen, touch Settings > Vehicle > Remote Lock, Unlock, Start.

Key Access

To access a vehicle with a weak remote key battery, see *Door Locks* ⇨ 13.

Programming Remote Keys to the Vehicle

Only remote keys programmed to the vehicle will work. If a remote key is lost or stolen, a replacement can be purchased and programmed through your dealer. The vehicle can be reprogrammed so that lost or stolen remote keys no longer work. Each vehicle can have up to eight remote keys programmed to it.



Programming with a Recognized Remote Key

A new remote key can be programmed to the vehicle when there are two recognized remote keys. To program, the vehicle must be on and the recognized and new remote keys must be with you.

1. Place the recognized remote keys on the passenger seat.
2. Navigate to, and select, "Remote Key Relearn" through the Driver Information Center (DIC).

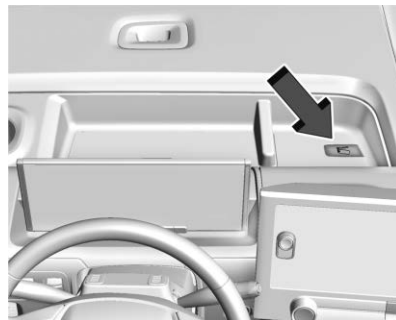
The DIC displays READY FOR REMOTE.



3. Place the new remote key in the storage compartment above and behind the infotainment display.
4. Press POWER . When the remote key is learned the DIC display will show that it is ready to program the next remote key.
5. Remove the remote key from the IP storage tray and press  or  on the remote key.

To program additional remote keys, repeat Steps 4–5.

When all additional remote keys are programmed, press and hold POWER  for approximately 12 seconds to exit programming mode.

Starting the Vehicle with a Low Remote Key Battery

For improved vehicle security, the remote key is equipped with a motion sensor. When starting the vehicle, if the remote key has been idle for an extended period of time, the DIC may display KEY IN SLEEP MODE, MOVE KEY, THEN START. Move the remote key slightly and try starting the vehicle.

If the remote key battery is weak or if there is interference with the signal, the DIC may display NO KEY FOUND, REPLACE BATTERY IN KEY or NO REMOTE KEY WAS DETECTED PLACE KEY IN KEY POCKET THEN START YOUR VEHICLE when starting the vehicle.

To start the vehicle:

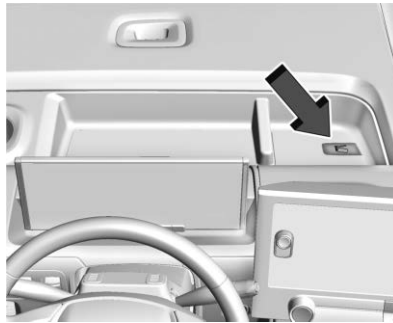

1. Place the remote key in the storage compartment above and behind the infotainment display.
2. With the vehicle in P (Park) or N (Neutral) press the brake pedal and POWER .

Replace the remote key battery as soon as possible.

Battery Replacement

Warning

Never allow children to play with the remote key. The remote key contains a small battery, which can be a choking hazard. If swallowed, internal burns can occur, resulting in severe injury or death. Seek medical attention immediately if a battery is swallowed.

Warning

To avoid personal injury, do not touch metal surfaces on the remote key when it has been exposed to extreme heat. These surfaces can be hot to the touch at temperatures above 59 °C (138 °F).

Caution

When replacing the battery, do not touch any of the circuitry on the remote key. Static from your body could damage the remote key.

12 Keys, Doors, and Windows

Caution

Always replace the battery with the correct type. Replacing the battery with an incorrect type could potentially create a risk of battery explosion. Dispose of used batteries according to instructions and local laws. Do not attempt to burn, crush, or cut the used battery, and avoid exposing the battery to environments with extremely low air pressures or high temperatures.

Caution

If the remote key is not reassembled properly, liquids could enter the housing and damage the circuitry, resulting in a remote key malfunction and/or failure. To prevent damage, always follow the steps for remote key reassembly in this manual to ensure the remote key is sealed properly whenever the remote key is opened.

Replace the battery in the remote key soon if the DIC displays REPLACE BATTERY IN KEY.

To replace the battery:



1. Press the button on the side of the remote key near the bottom and pull the mechanical key out. Never pull the mechanical key out without pressing the button.



2. Use the mechanical key blade in the slot to separate and remove the back cover.
3. Pull on the tab to access the battery.

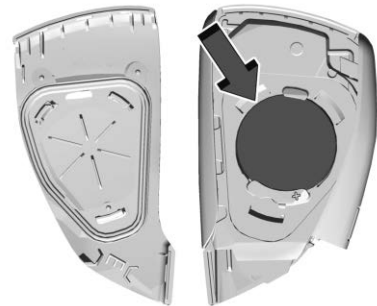

4. Lift the battery with a flat object. Do not use a metal object.
5. Remove the battery.
6. Insert the new battery, positive side toward the back cover. Replace with a CR2450 or equivalent battery.
7. Place the seal back into the groove around the battery compartment.
8. Push together the remote key.
9. Reinsert the mechanical key.

Remote Vehicle Start

If equipped with the remote start feature, the climate control system will come on when the vehicle is started remotely depending on the outside temperature.

The rear defog and heated and ventilated seats, if equipped, may also come on. To view available settings from the infotainment screen, touch Settings > Vehicle > Comfort and Convenience.

Laws in some communities may restrict the use of remote starters. Check local regulations for any requirements on remote starting of vehicles.

The vehicle cannot be remote started if:

- The remote key is in the vehicle.

- The hood is not closed.
- 60 minutes of total remote start time has been used.
- The hazard flashers are on.
- The vehicle is not in P (Park).
- The vehicle is not off.

The remote key range may be reduced while the vehicle is on.

Other conditions can affect the performance of the remote key. See *Remote Key* ⇨ 7. To view available settings from the infotainment screen, touch Settings > Vehicle > Remote Lock, Unlock, Start.

Starting the Vehicle Using Remote Start

1. Press  twice on the remote key. The turn signal lamps will flash. The lamps flash to confirm the request to remote start the vehicle has been received. During the remote start the parking lamps will remain on as long as the vehicle is on.
2. The vehicle will shut off after 60 minutes, unless you stop the remote start before cycle has completed or the vehicle is turned on.
3. Press the brake pedal and turn the vehicle on to drive the vehicle.

Extending Vehicle Remote Start Time

Remote start can be used for up to 60 minutes of total remote start time.

After a remote start of 60 minutes, or multiple shorter time starts totaling 60 minutes have been used, the vehicle must be started and then turned off before the remote start can be used again.

Canceling a Remote Start

To cancel a remote start, do one of the following:

- Press . The parking lamps will turn off.
- Turn on the hazard warning flashers.
- Turn the vehicle on and then off.

Door Locks

Warning

Unlocked doors can be dangerous.

- Passengers, especially children, can easily open the doors and fall out of a moving vehicle. The doors can be unlocked and opened while the vehicle is moving. The chance of being thrown out of the vehicle in a crash is increased if the doors are not locked.

(Continued)



Warning (Continued)

So, all passengers should wear seat belts properly and the doors should be locked whenever the vehicle is driven.



- Young children who get into unlocked vehicles may be unable to get out. A child can be overcome by extreme heat and can suffer permanent injuries or even death from heat stroke. Always lock the vehicle whenever leaving it.
- Outsiders can easily enter through an unlocked door when you slow down or stop the vehicle. Locking the doors can help prevent this from happening.

If necessary, clear snow and ice from around the doors before using them.

To lock or unlock the doors from outside the vehicle:

- Press  or  on the remote key. See *Remote Key Operation* ⇨ 7.

To lock or unlock the doors from inside the vehicle:

- Press  or  on the power door lock switch.

- Push the unlock lever below the door handle forward, and, while holding the lever in the pushed position, pull the handle.

Keyless Access





The remote key must be within 1 m (3 ft) of the door (including the rear sliding door) being opened or locked. Press the button near the door handle to open. See “Keyless Access Operation” in *Remote Key Operation* ⇨ 7.

Accessing the Vehicle Using the Mechanical Key

If the locks malfunction, or if the doors will not open due to loss of electrical power, use the mechanical key to enter the vehicle through the rear sliding door. See *Sliding Door (Bulkhead Door)* ⇨ 16

Power Door Locks

Press  or  on the Remote Key. See *Remote Key Operation* ⇨ 7.

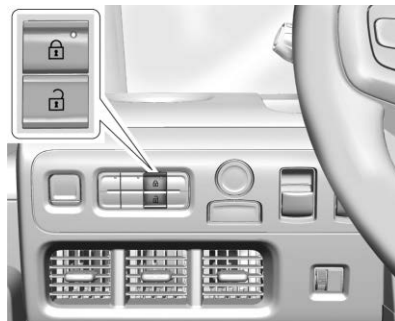

 : Press to lock the doors. The indicator light in the switch will illuminate when locked.

 : Press to unlock the doors.

Steering Wheel Switches

There are also switches on either side of the back of the steering wheel.

The switches on the driver side of the steering wheel lock or unlock the rear bulkhead door. The door will automatically lock again after a set amount of time when unlocked this way. See *Sliding Door (Bulkhead Door)* ⇨ 16.



The switches on the passenger side of the steering wheel lock or unlock the exterior doors, but not the bulkhead door.

Delayed Locking

This feature delays the locking of the doors until five seconds after all doors are closed.

When  is pressed on the power door lock switch while the door is open, a chime will sound three times indicating delayed locking is active.

The doors will lock automatically five seconds after all doors are closed. If a door is reopened before that time, the five-second timer will reset when all doors are closed again.

Press  on the door lock switch again or press  on the remote key to lock the doors immediately.

This feature can be programmed. To view available settings from the infotainment screen, touch Settings > Vehicle > Remote Lock, Unlock, Start.

Automatic Door Locks

The doors will lock automatically when all doors are closed, the vehicle is on, and the vehicle is shifted out of P (Park).

If a vehicle door is unlocked, and then opened and closed, the doors will lock either when your foot is removed from the brake or the vehicle speed becomes faster than 13 km/h (8 mph).

To unlock the doors:

- Press  on the power door lock switch.
- Shift the electric drive unit into P (Park).

Automatic door locking cannot be disabled. Automatic door unlocking can be programmed. If the vehicle is in delivery mode, it will always unlock when shifted to park. To view available settings from the infotainment screen, touch Settings > Vehicle > Remote Lock, Unlock, Start.

Lockout Protection

When locking is requested with the driver door open and the vehicle is on, all the doors will lock and then the driver door will unlock.

If the vehicle is off and locking is requested while a door is open, when all doors are closed the vehicle will check for remote keys inside. If a remote key is detected and the number of remote keys inside has not reduced, the driver door will unlock and the horn will sound three times.

This can be manually overridden by pressing and holding  on the power door lock switch.

Doors

Sliding Door (Bulkhead Door)

Cab Area Access



To open, unlock using the touchpad, then pull the handle and slide the door to the side until it latches.

Auto Open to the Cargo Area

If equipped with an auto open bulkhead door, the bulkhead door will open automatically if the vehicle is on and you do one of the following:

- Press the touchpad on the wall next to the bulkhead door while the remote key is inside the vehicle.

- Press the lower button on the back of the drivers side of the steering wheel.
- Shift into P (Park) while the vehicle is in Delivery Mode.

To close, pull the handle again and slide it closed until it latches. The bulkhead door will automatically lock upon closing.

Cargo Area Access



1. Handle
2. Unlock Lever

If the door is unlocked:

To open, pull the handle and slide the door to the side.

To close, pull the handle again and slide it closed until it latches.

If the door is locked:

To open, either:

- Push the unlock lever to the right and hold it while pulling the handle.
- Use the remote key to unlock the vehicle and then pull the handle

Auto Open to Cab Area

If equipped with an auto open bulkhead door, and the bulkhead door is unlocked, pull the handle until the door unlatches and then release the handle to open the door.

If the bulkhead door is locked, push the unlock lever to the right and hold it while pulling the handle. Once the handle unlatches, release the handle to open the door.

To close, pull the handle again and slide it closed until it latches. The bulkhead door will automatically lock upon closing.

Rear Doors (Exterior)

Warning

While opening or closing the rear cargo door, people can be injured by the moving parts of the door. When the rear cargo door is open, the vertical clearance height of the cargo space is reduced. A person standing in this area could injure his/her head and/or other body part. To avoid vehicle damage and/or personal injury, be aware of the position of the door and keep your hands away from moving parts and door tracks.

Opening and Closing from the Outside

To open, with the remote key within range and outside of the vehicle, unlock the door using the exterior touchpad (or exterior mechanical emergency key if necessary). Turn the unlatch handle clockwise and push/pull up on the unlatch handle and then grab the lower handle to move the door upward and toward the front of the vehicle until the door opens completely.

When using the mechanical key to open the door, carefully remove the exterior cover, insert the mechanical key, and then rotate it

counter-clockwise to unlock the rear door. The mechanical key must be held in the lock position while opening the door. After the door is opened completely, the mechanical key must be rotated clockwise fully before removing it from the lock. Carefully reinstall the cover with the notch in the original position.

If the door does not unlock while opening, make sure that it is completely closed by pushing downward on the lower handle before repeating the procedure.



Keyless Access



Key Access

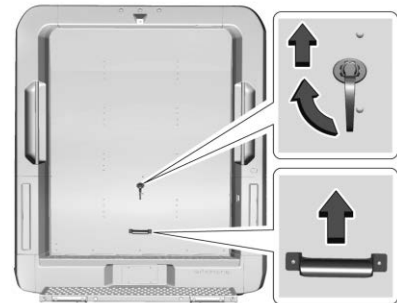

Opening Procedure

18 Keys, Doors, and Windows

To close, pull the door strap on passenger side of vehicle and then use the lower handle to complete the closure. The door will roll rearward and downward to latch into closed position.

Avoid potential contact with the closing door by ensuring that there is no object in the way of the movement of the door.

Make sure the rear cargo door is completely closed before driving away.

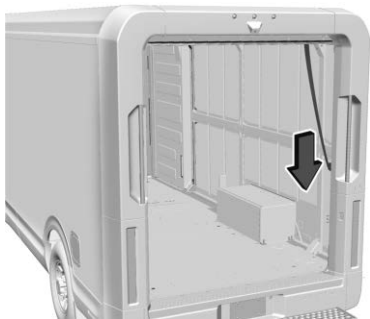

Closing Using the Strap

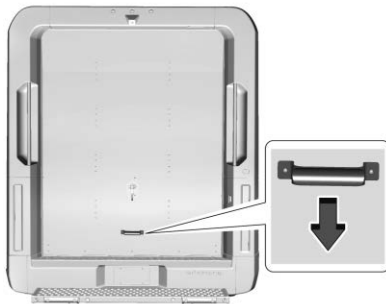

Closing Using the Handle

Opening and Closing from the Inside

To open, unlock using the interior touchpad. Push the inside handle down and to the passenger side until the handle stops moving. Once the inside handle is in position, keep the handle in place while using the handle to pull the door open. The door will move overhead in upward and forward motion in vehicle to open completely.

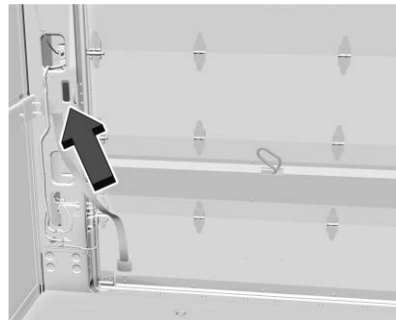

Unlocking Procedure

In case of power loss to the rear door lock, the lock can be activated manually. Pull the tab on the lock, located above the touchpad, to manually unlock the door. The lock must be held open to while activating it manually.

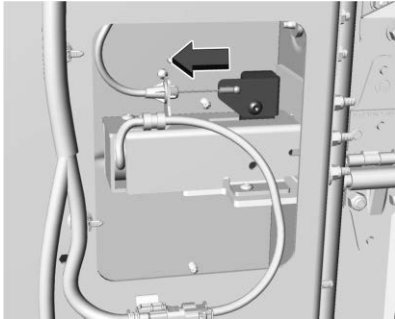

In case the door does not unlock while opening, make sure that the door is completely closed by pushing downward on the top surface of the latching cover before repeating the procedure.

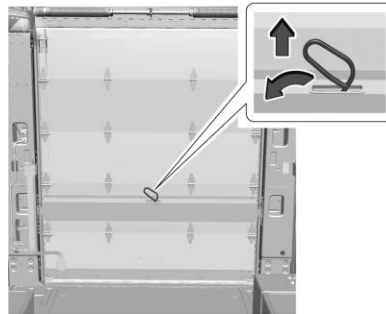

Opening Procedure

To close, pull the door strap on passenger side of vehicle and then push down on the top surface of the latching cover to close the door. The door will roll overhead in a rearward and downward motion to latch into the closed position.

Avoid potential contact with the closing door by ensuring that there is no object in the way of the movement of the door.

Make sure the door is completely closed before driving away.

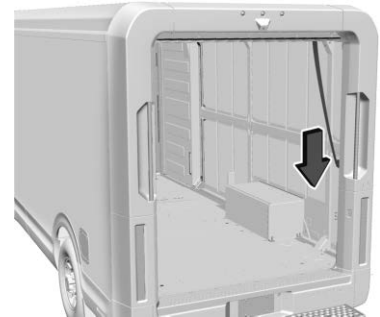

Closing Using the Strap

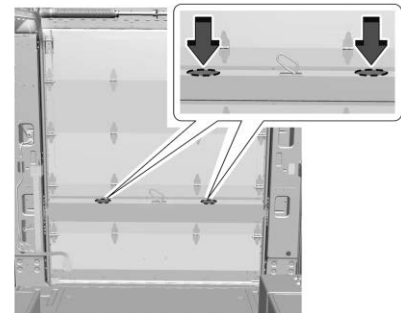

Push to Latch

The rear door is equipped with a locking system that will lock the door once the door is completely closed.

When using the touchpad (inside or outside) to unlock the door and allow for door to open, there is a seven-second time window to open the door from when the touchpad is pressed.

If the door is not opened within the seven-second timeframe, the door may lock and prevent the door from opening.

If this occurs, repeat the unlock operation by pressing the touchpad to allow the door to open.



Vehicle Security

This vehicle has theft-deterrent features; however, they do not make the vehicle impossible to steal.

Vehicle Alarm System

Arming the Alarm System

1. Turn off the vehicle.
2. Lock the vehicle in one of three ways:
 - Use the remote key.
 - Use the Keyless Access system.

- With a door open, press  on the interior of the door.
3. After 30 seconds the alarm system will arm, and the indicator light will begin to slowly flash. Pressing  on the remote key a second time will bypass the 30-second delay and immediately arm the alarm system.

The vehicle alarm system will not arm if the doors are locked with the mechanical key.

If the driver door is opened without first unlocking with the remote key, the horn will chirp and the lights will flash to indicate pre-alarm. If the vehicle is not started, or the door is not unlocked by pressing  on the remote key during the 10-second pre-alarm, the alarm will be activated.

The alarm will also be activated if a passenger door, the liftgate, or the hood is opened without first disarming the system. When the alarm is activated, the turn signals flash and the horn sounds for about 30 seconds. The alarm system will then re-arm to monitor for the next unauthorized event.

Disarming the Alarm System

To disarm the alarm system or turn off the alarm if it has been activated:

- Press  on the remote key.
- Unlock the vehicle using the Keyless Access system.
- Start the vehicle.

To avoid setting off the alarm by accident:

- Lock the vehicle after all occupants have exited.
- Always unlock a door with the remote key, or use the Keyless Access system.

Unlocking the driver door with the mechanical key will not disarm the system or turn off the alarm.

How to Detect a Tamper Condition

If  is pressed on the remote key and the horn chirps three times, an alarm occurred previously while the alarm system was armed.

If the alarm has been activated, a message will appear on the DIC.

Inclination Sensor and Intrusion Sensor

In addition to the standard theft-deterrent system features, this system may also have a inclination sensor and intrusion sensor.

The inclination sensor can set off the alarm if it senses movement of the vehicle, such as a change in vehicle orientation.

The intrusion sensor monitors the vehicle interior, and can activate the alarm if it senses unauthorized entry into the vehicle's interior.

Before arming the theft-deterrent system and activating the intrusion sensor:

- Make sure all doors and windows are completely closed.
- Secure any loose items such as a sunshades.
- Make sure there are no obstructions blocking the sensors in the front overhead console.

Steering Column Lock

If equipped, the steering column lock is a theft-deterrent device. This feature locks the steering column when the vehicle is turned off and the driver door is opened, or when

the driver door is opened and then the vehicle is turned off. The steering column unlocks when the vehicle is turned on.

The Driver Information Center (DIC) may display one of these messages:

- A message to service the steering column lock indicates that an issue has been detected with the column lock feature and the vehicle should be serviced.
- A message that the steering column is locked indicates that the vehicle is on, but the steering column is still locked. It is normal for the column to be locked during a remote start, but the column should unlock after the brake pedal is pressed and the vehicle is started. No message will display during a remote start.
- A message that the steering wheel must be turned and the vehicle must be started again indicates that the column lock mechanism is bound, the column locking device was unable to unlock the steering column, and the vehicle did not start. If this happens, turn the steering wheel from side to side to unbind the column lock. If this does not unlock the steering column, turn the vehicle off and open the driver door to reset the system. Then turn

the vehicle on and turn the steering wheel side to side for about 15 seconds. In some cases, it may take significant force to unbind the column.

To keep the steering column from binding, straighten the front wheels before turning off the vehicle.

Immobilizer

See *Radio Frequency Statement* ⇨ 237.

Immobilizer Operation

This vehicle has a passive theft-deterrent system.

The system does not have to be manually armed or disarmed.

The vehicle is automatically immobilized when the vehicle is turned off.

The immobilization system is disarmed when the vehicle is turned on and a valid remote key is present in the vehicle.



The security light, in the instrument cluster, comes on if there is a problem with arming or disarming the theft-deterrent system.

The system has one or more remote keys matched to an immobilizer control unit in the vehicle. Only a correctly matched remote key will start the vehicle. If the remote key is ever damaged, you may not be able to start your vehicle.

When trying to start the vehicle, the security light may come on briefly.

If the vehicle does not start and the security light stays on, there is a problem with the system. Turn the vehicle off and try again.

If the vehicle will not turn on or off, and the remote key appears to be undamaged, try another remote key. Or, you may try placing the remote key in the backup location. See *Remote Key Operation* ⇨ 7.

If the vehicle will not turn on or off with the other remote key or in the backup location, the vehicle needs service. If the vehicle does turn on or off, the first remote key may be faulty. See your dealer.

It is possible for the immobilizer system to learn new or replacement remote keys. Up to eight remote keys can be programmed for the vehicle. To program additional

remote keys, see “Programming Remote Keys to the Vehicle” under *Remote Key Operation* ⇨ 7.

Do not leave the remote key or device that disarms or deactivates the theft-deterrent system in the vehicle.

Exterior Mirrors

Convex Mirrors

Warning

A convex mirror can make things, like other vehicles, look farther away than they really are. If you cut too sharply into the next lane, you could hit a vehicle that is driving next to you. Check the inside mirror or glance over your shoulder before changing lanes.



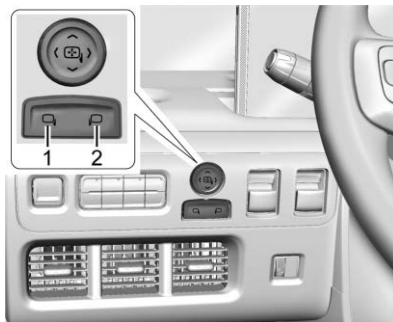

The upper portion of both the driver and passenger side mirrors is flat.

The lower portion of each mirror is convex. A convex mirror surface is curved so more can be seen from the driver seat. The convex portions of each mirror can be adjusted manually.

Power Mirrors



To adjust the mirrors:

1. Press  (1) or  (2) to select the driver or passenger side mirror. The indicator light comes on.
2. Press the arrows on the control pad to move the mirror up, down, right, or left.
3. Adjust the outside mirror so that the side of the vehicle and the area behind are seen.
4. Press either  or  again to deselect the mirror. The indicator light goes off.

Puddle Lamps

If equipped, puddle lamps project light to the area of ground below the front and rear doors, on both the driver and passenger side. See *Entry Lighting* ⇨ 81 and *Exit Lighting* ⇨ 81.

Side Blind Zone Alert (SBZA)

The vehicle may have SBZA. See *Side Blind Zone Alert (SBZA)* ⇨ 156.

Folding Mirrors

Fold the mirrors inward to prevent damage when going through an automatic car wash. To fold, pull the mirror toward the vehicle. Push the mirror outward, to return to its original position.

Heated Mirrors



Press the button located below the infotainment display to activate the heated mirrors. The indicator light will illuminate when active.

Windows

Warning

Never leave a child, a helpless adult, or a pet alone in a vehicle, especially with the windows closed in warm or hot weather. They can be overcome by the extreme heat and suffer permanent injuries or even death from heat stroke.



Power Windows

Warning

Children could be seriously injured or killed if caught in the path of a closing window. Never leave the remote key in a vehicle with children. When there are children in the rear seat, use the window lockout switch to prevent operation of the windows. See *Keys* ⇨ 6.

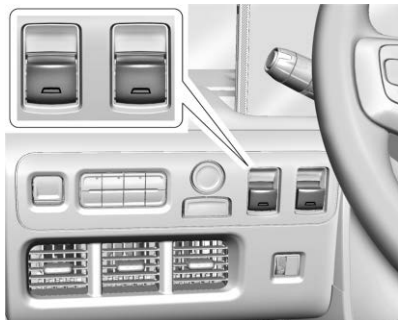

The power windows work when the vehicle is on, or when Retained Accessory Power (RAP) is active. See *Retained Accessory Power (RAP)* ⇨ 122.

Using the window switch, press to open or pull to close the window.

The windows may be temporarily disabled if they are used repeatedly within a short time.

Windows Express Movement

If equipped, all windows can be opened without holding the window switch. Press the switch down fully and quickly release to express open the window.

Briefly press or pull the window switch to stop that window's express movement.

Remote Window Operation

If equipped, this feature allows the windows to be opened remotely. If enabled in vehicle personalization, press and hold  on the remote key. To view available settings from the infotainment screen, touch Settings > Vehicle > Remote Lock, Unlock, Start.

Sun Visors

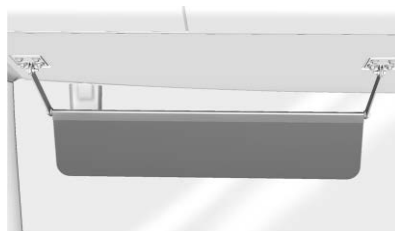

Pull the sun visor down to block glare.

Seats and Restraints

Head Restraints

Head Restraints 25

Front Seats

Seat Adjustment 26
 Reclining Seatbacks 27
 Heated Front Seats 28
 Jump Seat 29

Seat Belts

Seat Belts 29
 Buckle To Drive 30
 How to Wear Seat Belts Properly 30
 Lap-Shoulder Belt 32
 Seat Belt Use During Pregnancy 34
 Seat Belt Extender 35
 Safety System Check 35
 Seat Belt Care 35
 Replacing Seat Belt System Parts after a
 Crash 35

Airbag System

Airbag System 36
 Where Are the Airbags? 37
 When Should an Airbag Inflate? 38
 What Makes an Airbag Inflate? 39
 How Does an Airbag Restrain? 39
 What Will You See after an Airbag
 Inflates? 40

Servicing the Airbag-Equipped
 Vehicle 41
 Adding Equipment to the
 Airbag-Equipped Vehicle 41
 Airbag System Check 41
 Replacing Airbag System Parts after a
 Crash 42

Child Restraints

Older Children 42
 Infants and Young Children 44
 Where to Put the Restraint 45

Head Restraints

The vehicle's front driver seat has an adjustable head restraint.

Warning

With head restraints that are not installed and adjusted properly, there is a greater chance that occupants will suffer a neck/spinal injury in a crash. Do not drive until the head restraints for all occupants are installed and adjusted properly.

If your vehicle has rear head restraints that fold down, always return them to the full upright position whenever an occupant is seated in the seat.



Adjust the head restraint so that the top of the restraint is at the same height as the top of the occupant's head. This position reduces the chance of a neck injury in a crash.

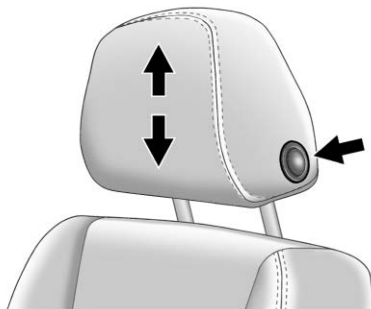

To raise or lower the head restraint, press the button located on the side of the head restraint and pull up or push the head restraint down, and release the button. Pull and push on the head restraint after the button is released to make sure that it is locked in place.

The front seat head restraint is not removable.

Front Seats

Seat Adjustment



Warning

You can lose control of the vehicle if you try to adjust a driver seat while the vehicle is moving. Adjust the driver seat only when the vehicle is not moving.



To adjust the seat position:

1. Pull the handle at the front of the seat cushion to unlock it.
2. Move the seat forward or rearward and release the handle.

3. Try to move the seat back and forth to be sure it is locked in place.

Seat Height Adjuster



Move the lever up or down to raise or lower the seat.

Reclining Seatbacks

Warning

Sitting in a reclined position when the vehicle is in motion can be dangerous. Even when buckled up, the seat belts cannot do their job.

(Continued)

Warning (Continued)

The shoulder belt will not be against your body. Instead, it will be in front of you. In a crash, you could go into it, receiving neck or other injuries.

The lap belt could go up over your abdomen. The belt forces would be there, not at your pelvic bones. This could cause serious internal injuries.

For proper protection when the vehicle is in motion, have the seatback upright. Then sit well back in the seat and wear the seat belt properly.



Do not have a seatback reclined if the vehicle is moving.

Warning

If either seatback is not locked, it could move forward in a sudden stop or crash. That could cause injury to the person sitting there. Always push and pull on the seatbacks to be sure they are locked.



To recline the seatback:

1. Lift the lever.
2. Move the seatback to the desired position, and then release the lever to lock the seatback in place.

3. Push and pull on the seatback to make sure it is locked.

To return the seatback to the upright position:

1. Lift the lever fully without applying pressure to the seatback, and the seatback will return to the upright position.
2. Push and pull on the seatback to make sure it is locked.

Heated Front Seats

Warning

If temperature change or pain to the skin cannot be felt, the seat heater may cause burns. To reduce the risk of burns, use care when using the seat heater, especially for long periods of time. Do not place anything on the seat that insulates against heat, such as a blanket, cushion, cover, or similar item. This may cause the seat heater to overheat. An overheated seat heater may cause a burn or may damage the seat.



If equipped, the button is on the center stack. To operate, the vehicle must be on.

Press  to heat the cushion and seatback.

The indicator light comes on when this feature is on.

Press the button once for the highest setting. With each press of the button, the seat will change to the next lower setting, and then to the off setting. The indicator lights next to the button indicate three for the highest setting and one for the lowest. If the heated seat is on high, the level may automatically be lowered after approximately 30 minutes.

Auto Heated Seats

When the vehicle is on, this feature, if equipped, will automatically activate the heated seats and heated steering wheel, if equipped, at the level required by the vehicle's interior temperature.

The active high, medium, low, or off heated seat level will be indicated by the manual heated seat button on the center stack. Use the manual heated seat button on the center stack to turn auto heated seats off. The auto heated seats and steering wheel can also be turned off using the heated steering wheel button. To enable or disable auto heated seats, select Settings > Vehicle > Climate and Air Quality > Auto Heated Seats > ON or OFF.

Remote Start Heated Seats

During a remote start, the heated seat can be turned on automatically. When it is cold outside, the heated seat turns on. The heated seat may be canceled when the vehicle is turned on. If necessary, press the heated seat button to use the heated seat after the vehicle is turned on.

The heated seat indicator light may turn on during a remote start.

The temperature performance of an unoccupied seat may be reduced. This is normal.

To enable or disable remote start heated seats, select Settings > Vehicle > Remote Lock, Unlock, and Start > Remote Start Auto Heat Seat > ON or OFF. See *Remote Vehicle Start* ⇨ 13.

Jump Seat

The vehicle may be equipped with a front passenger jump seat.



To use the jump seat, pull down on the seat cushion until the seat is in place. To store the seat, return the seat cushion to the upright position.

Seat Belts

This section describes how to use seat belts properly, and some things not to do.

Warning

Do not let anyone ride where a seat belt cannot be worn properly. In a crash, if you or your passenger(s) are not wearing seat belts, injuries can be much worse than if you are wearing seat belts. You can be seriously injured or killed by hitting things inside the vehicle harder or by being ejected from the vehicle. In addition, anyone who is not buckled up can strike other passengers in the vehicle.

It is extremely dangerous to ride in a cargo area, inside or outside of a vehicle. In a collision, passengers riding in these areas are more likely to be seriously injured or killed. Do not allow passengers to ride in any area of the vehicle that is not equipped with seats and seat belts.

Always wear a seat belt, and check that all passenger(s) are restrained properly too.

This vehicle has indicators as a reminder to buckle the seat belts. See *Seat Belt Reminders* ⇨ 59.

Why Seat Belts Work

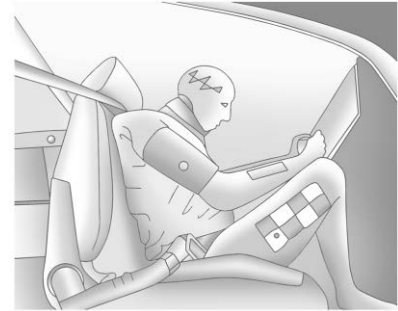

When riding in a vehicle, you travel as fast as the vehicle does. If the vehicle stops suddenly, you keep going until something stops you. It could be the windshield, the instrument panel, or the seat belts!

When you wear a seat belt, you and the vehicle slow down together. There is more time to stop because you stop over a longer distance and, when worn properly, your strongest bones take the forces from the seat belts. That is why wearing seat belts makes such good sense.

Questions and Answers About Seat Belts

Q: Will I be trapped in the vehicle after a crash if I am wearing a seat belt?

A: You *could* be — whether you are wearing a seat belt or not. Your chance of being conscious during and after a crash, so you *can* unbuckle and get out, is *much* greater if you are belted.

Q: If my vehicle has airbags, why should I have to wear seat belts?

A: Airbags are supplemental systems only. They work *with* seat belts — not instead of them. Whether or not an airbag is provided, all occupants still have to buckle up to get the most protection.

Also, in nearly all states and in all Canadian provinces, the law requires wearing seat belts.

Buckle To Drive

This feature delays the vehicle from shifting out of P (Park) when the driver seat belt is not buckled.

If the vehicle is on and the brake pedal is pressed with the vehicle in P (Park) but the driver seat belt is not buckled, a message displays in the Driver Information

Center (DIC) and the vehicle will be delayed from shifting out of P (Park). Buckle the driver seat belt to clear the message and shift out of P (Park). Shifting from P (Park) will be delayed once for each time the vehicle is started.

If the driver remains unbuckled, the DIC message will turn off after several seconds and the vehicle can be shifted out of P (Park). See “Seat Belts” in the Index for information about the importance of proper restraint use.

If the driver seat belt is unbuckled when driving, the seat belt reminder chime and light(s) will come on. See *Seat Belt Reminders* ⇨ 59.

How to Wear Seat Belts Properly

Follow these rules for everyone’s protection.

There are additional things to know about seat belts and children, including smaller children and infants. If a child will be riding in the vehicle, see *Older Children* ⇨ 42 or *Infants and Young Children* ⇨ 44. Review and follow the rules for children in addition to the following rules.

It is very important for all occupants to buckle up. Statistics show that unbelted people are hurt more often in crashes than those who are wearing seat belts.

There are important things to know about wearing a seat belt properly.

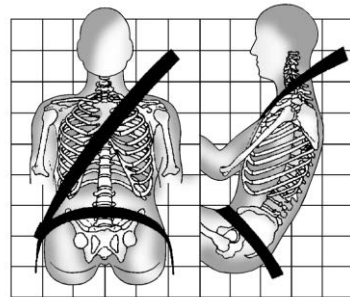

- Sit up straight and always keep your feet on the floor in front of you (if possible).
- Wear the lap part of the belt low and snug on the hips, just touching the thighs. In a crash, this applies force to the strong pelvic bones and you would be less likely to slide under the lap belt. If you slid under it, the belt would apply force on your abdomen. This could cause serious or even fatal injuries.

- Wear the shoulder belt over the shoulder and across the chest. These parts of the body are best able to take belt restraining forces. The shoulder belt locks if there is a sudden stop or crash.

Warning

You can be seriously injured, or even killed, by not wearing your seat belt properly.

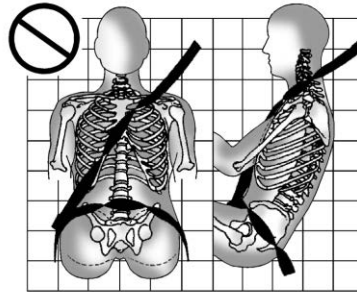
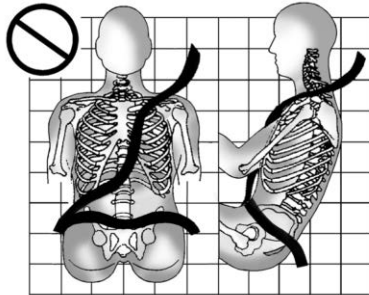

Never allow the lap or shoulder belt to become loose or twisted.

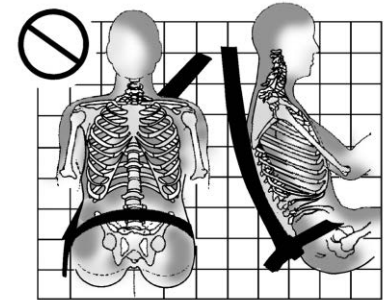
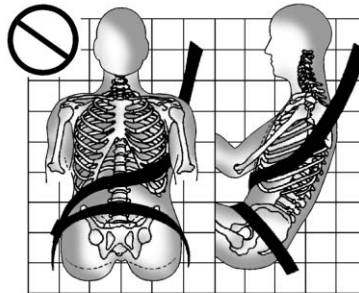

Never wear the shoulder belt under both arms or behind your back.

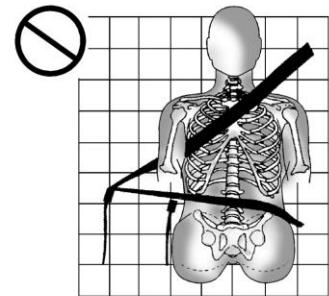

Always use the correct buckle for your seating position.

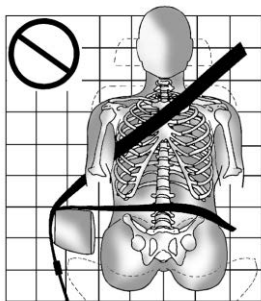

Never route the lap or shoulder belt over an armrest.

Warning

The seat belt can be pinched if it is routed under plastic trim on the seat, such as trim around the rear seatback folding handle or side airbag. In a crash, pinched seat belts might not provide adequate protection. Never allow seat belts to be routed under plastic trim pieces.

Warning

You can be seriously injured or killed if the shoulder belt is worn behind your back, under your legs, or wrapped around your neck. The shoulder belt can tighten but cannot be loosened if it is locked. The shoulder belt locks when it is pulled all the way out of the retractor. It unlocks when the shoulder belt is allowed to go all the way back into the retractor, but it cannot do this if it is wrapped around you. You may have to cut the seat belt if it is locked and tightened around you.

Lap-Shoulder Belt

All seating positions in the vehicle have a lap-shoulder belt.

The following instructions explain how to wear a lap-shoulder belt properly.



If the seat has a seat belt guide, the seat belt must be routed through the guide to properly position the shoulder belt. If the seat belt is not routed through the guide, slide the edge of the belt webbing through the opening on the guide. Be sure the belt is not twisted.

1. Adjust the seat, if the seat is adjustable, so you can sit up straight. To see how, see “Seats” in the Index.
2. Pick up the latch plate and pull the belt across you. Do not let it get twisted. If equipped with shoulder belt retractor lock feature on passenger belt, the shoulder portion of the belt may lock when the belt is pulled out all the way

or if pulled very rapidly. If this occurs, let the belt go back all the way and start again.

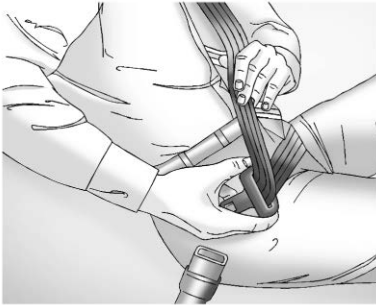

If the webbing locks in the latch plate before it reaches the buckle, tilt the latch plate flat to unlock.

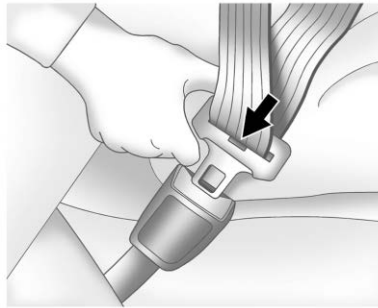

3. Push the latch plate into the buckle until it clicks.

Pull up on the latch plate to make sure it is secure.

If the belt is not long enough, see *Seat Belt Extender* ⇨ 35.

Position the release button on the buckle so that the seat belt could be quickly unbuckled if necessary.

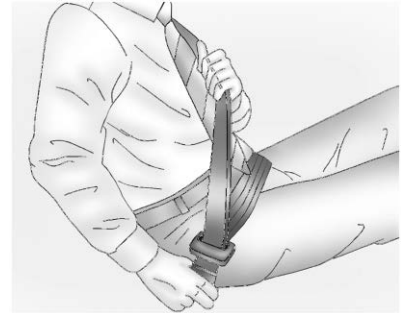

4. To make the lap part tight, pull up on the shoulder belt.

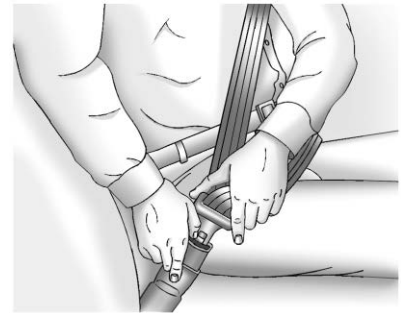

To unlatch the belt, push the button on the buckle. The belt should return to its stowed position.

Always stow the seat belt slowly. If the seat belt webbing returns quickly to the stowed position, the retractor may lock and cannot be pulled out. If this happens, pull the seat belt straight out firmly to unlock the webbing, and then release it. If the webbing is still locked in the retractor, see your dealer.

Before a door is closed, be sure the seat belt is out of the way. If a door is slammed against a seat belt, damage can occur to both the seat belt and the vehicle.

Seat Belt Pretensioners

This vehicle has seat belt pretensioners for the driver seat.

Although the seat belt pretensioners cannot be seen, they are part of the seat belt assembly. They can help tighten the seat belts during the early stages of a moderate to severe frontal, near frontal, side, roll over, or rear crash if the threshold conditions for pretensioner activation are met.

Pretensioners work only once. If the pretensioners activate in a crash, the pretensioners and probably other parts of the vehicle's seat belt system will need to be replaced. See *Replacing Seat Belt System Parts after a Crash* ⇨ 35.

Do not sit on the outboard seat belt while entering or exiting the vehicle or at any time while sitting in the seat. Sitting on the seat belt can damage the webbing and hardware.

Seat Belt Use During Pregnancy

Seat belts work for everyone, including pregnant women. Like all occupants, they are more likely to be seriously injured if they do not wear seat belts.



A pregnant woman should wear a lap-shoulder belt, and the lap portion should be worn as low as possible, below the rounding, throughout the pregnancy.

The best way to protect the fetus is to protect the mother. When a seat belt is worn properly, it is more likely that the fetus will not be hurt in a crash. For pregnant women, as for anyone, the key to making seat belts effective is wearing them properly.

Seat Belt Extender

If the vehicle's seat belt will fasten around you, you should use it.

But if a seat belt is not long enough, your dealer will order you an extender. Only a GM dealer issued extender should be used. When you go in to order it, take the heaviest coat you will wear, so the extender will be long enough for you. To help avoid personal injury, do not let someone else use it, and use it only for the seat it is made to fit. The extender has been designed for adults. Never use it for securing child restraints. For more information on the proper use and fit of seat belt extenders see the instruction sheet that comes with the extender.

Safety System Check

Periodically check the seat belt reminder, seat belts, buckles, latch plates, retractors, shoulder belt height adjusters (if equipped), and seat belt anchorages to make sure they are all in working order. Look for any other loose or damaged seat belt system parts that might keep a seat belt system from performing properly. See your dealer to have it repaired. Torn, frayed, or twisted seat belts may not protect you in a crash.

Torn or frayed seat belts can rip apart under impact forces. If a belt is torn or frayed, have it replaced immediately. If a belt is twisted, it may be possible to untwist by reversing the latch plate on the webbing. If the twist cannot be corrected, ask your dealer to fix it.

Make sure the seat belt reminder light is working. See *Seat Belt Reminders* ⇨ 59.

Keep seat belts clean and dry. See *Seat Belt Care* ⇨ 35.

Seat Belt Care

Keep belts clean and dry.

Seat belts should be properly cared for and maintained.

Seat belt hardware should be kept dry and free of dust or debris. As necessary, exterior hard surfaces and seat belt webbing may be lightly cleaned with mild soap and water. Ensure there is not excessive dust or debris in the mechanism. If dust or debris exists in the system please see the dealer. Parts may need to be replaced to ensure proper functionality of the system.

Warning

Do not bleach or dye seat belt webbing. It may severely weaken the webbing. In a crash, they might not be able to provide adequate protection. Clean and rinse seat belt webbing only with mild soap and lukewarm water. Allow the webbing to dry.

Replacing Seat Belt System Parts after a Crash

Warning

A crash can damage the seat belt system in the vehicle. A damaged seat belt system may not properly protect the person using it, resulting in serious injury or even death in a crash. To help make sure the seat belt systems are working properly after a crash, have them inspected and any necessary replacements made as soon as possible.

After a minor crash, replacement of seat belts may not be necessary. But the seat belt assemblies that were used during any

crash may have been stressed or damaged. See your dealer to have the seat belt assemblies inspected or replaced.

New parts and repairs may be necessary even if the seat belt system was not being used at the time of the crash.

Have the seat belt pretensioners checked if the vehicle has been in a crash, or if the airbag readiness light stays on after you start the vehicle or while you are driving. See *Airbag Readiness Light* ⇨ 59.

Airbag System

The vehicle does not have a frontal airbag for the passenger.

The vehicle has the following airbags:

- A frontal airbag for the driver
- A seat-mounted side impact airbag for the driver
- A roof-rail airbag for the driver

The vehicle may have the following airbags:

- A passenger side impact airbag
- A roof-rail airbag for the front outboard passenger

All vehicle airbags have the word AIRBAG on the trim or on an attached label near the deployment opening.

For the frontal airbag, the word AIRBAG is on the center of the steering wheel for the driver.

For the driver seat-mounted side impact airbag, the word AIRBAG is on the side of the seatback or side of the seat closest to the door.

For the passenger side impact airbag, the word AIRBAG is on the airbag trim cover.

For roof-rail airbags, the word AIRBAG is on the ceiling or trim.

Airbags are designed to supplement the protection provided by seat belts. Even though today's airbags are also designed to help reduce the risk of injury from the force of an inflating airbag, all airbags must inflate very quickly to do their job.

Here are the most important things to know about the airbag system:

Warning

You can be severely injured or killed in a crash if you are not wearing your seat belt, even with airbags. Airbags are designed to work with seat belts, not replace them. Also, airbags are not designed to inflate in every crash. In some crashes seat belts are the only restraint. See *When Should an Airbag Inflate?* ⇨ 38.

Wearing your seat belt during a crash helps reduce your chance of hitting things inside the vehicle or being ejected from it. Airbags are “supplemental restraints” to the seat belts. Everyone in the vehicle should wear a seat belt properly, whether or not there is an airbag for that person.

Warning

Because airbags inflate with great force and faster than the blink of an eye, anyone who is up against, or very close to any airbag when it inflates can be seriously injured or killed. Do not sit

(Continued)

Warning (Continued)

unnecessarily close to any airbag, as you would be if sitting on the edge of the seat or leaning forward. Seat belts help keep you in position before and during a crash. Always wear a seat belt, even with airbags. The driver should sit as far back as possible while still maintaining control of the vehicle. The seat belt and the frontal airbag are most effective when you are sitting well back and upright in the seat with both feet on the floor.

Warning

Children who are up against, or very close to, any airbag when it inflates can be seriously injured or killed. Always secure children properly in the vehicle. To read how, see *Older Children* ⇨ 42 or *Infants and Young Children* ⇨ 44.



There is an airbag readiness light on the instrument panel, which shows the airbag symbol.

The system checks the airbag electrical system for malfunctions. The light tells you if there is an electrical problem. See *Airbag Readiness Light* ⇨ 59.

Where Are the Airbags?



The driver frontal airbag is in the center of the steering wheel.



The vehicle has a seat-mounted side impact airbag for the driver in the side of the seatback closest to the door.



If equipped, the passenger side impact airbag is on the airbag trim cover adjacent to the jumpseat.



Driver Side Shown, Passenger Side Similar

If the vehicle has roof-rail airbags for the driver and front outboard passenger, they are in the ceiling above the side windows.

Warning

If something is between an occupant and an airbag, the airbag might not inflate properly or it might force the object into that person causing severe injury or even death. The path of an inflating airbag must be kept clear. Do not put anything between an occupant and an airbag, and do not attach or put anything on the steering wheel hub or on or near any other airbag covering.

Do not use seat accessories that block the inflation path of a seat-mounted side impact airbag.

Never secure anything to the roof of a vehicle with roof-rail airbags by routing a rope or tie-down through any door or window opening. If you do, the path of an inflating roof-rail airbag will be blocked.

When Should an Airbag Inflate?

This vehicle is equipped with one or more airbags. See *Airbag System* ⇨ 36. Airbags are designed to inflate if the impact exceeds the specific airbag system's deployment threshold. Deployment thresholds are used to predict how severe a crash is likely to be in time for the airbags to inflate and help restrain the occupants. The vehicle has electronic sensors which help the airbag system determine the severity of the impact. Deployment thresholds can vary with specific vehicle design.

The frontal airbag is designed to inflate in moderate to severe frontal crashes to help reduce the potential for severe injuries mainly to the driver's head and chest.

Whether the frontal airbag will or should deploy is not based primarily on how fast the vehicle is traveling. It depends largely on what you hit, the direction of the impact, and how quickly the vehicle slows down.

The frontal airbag may inflate at different crash speeds depending on whether the vehicle hits an object straight on or at an angle, and whether the object is fixed or moving, rigid or deformable, narrow or wide.

The frontal airbag is not intended to inflate during vehicle rollovers, rear impacts, or in many side impacts.

In addition, the vehicle has an advanced technology frontal airbag. An advanced technology frontal airbag adjusts the restraint according to crash severity.

Seat side impact airbags, if equipped, are designed to inflate in moderate to severe side crashes depending on the location of the impact. These airbags may also inflate in some moderate to severe frontal impacts. Seat side impact airbags are not designed to inflate in rollovers or rear impacts. A seat side impact airbag is intended to inflate on the side of the vehicle that is struck.

Roof-rail airbags, if equipped, are designed to inflate in moderate to severe side crashes depending on the location of the impact. In addition, these roof-rail airbags may inflate during a rollover or in a severe frontal impact. Roof-rail airbags are not designed to inflate in rear impacts. Both roof-rail airbags may inflate when either side of the vehicle is struck or if the sensing system predicts that the vehicle is about to roll over on its side, or in a severe frontal impact.

In any particular crash, no one can say whether an airbag should have inflated simply because of the vehicle damage or repair costs.

What Makes an Airbag Inflate?

In a deployment event, the sensing system sends an electrical signal triggering a release of gas from the inflator. Gas from the inflator fills the airbag causing the bag to break out of the cover. The inflator, the airbag, and related hardware are all part of the airbag module.

For airbag locations, see *Where Are the Airbags?* ⇨ 37.

How Does an Airbag Restrain?

In moderate to severe frontal or near frontal collisions, even belted occupants can contact the steering wheel or the instrument panel.

In moderate to severe side collisions, even belted occupants can contact the inside of the vehicle.

Airbags supplement the protection provided by seat belts by distributing the force of the impact more evenly over the occupant's body.

This vehicle does not have a passenger frontal airbag in the passenger side instrument panel. Whether or not an airbag is provided, all occupants still have to buckle up to get the most protection. See *Seat Belts* ⇨ 29 and *How to Wear Seat Belts Properly* ⇨ 30.

Rollover capable roof-rail airbags are designed to help contain the head and chest of occupants in the outboard seating positions in the front row. The rollover capable roof-rail airbags are designed to help reduce the risk of full or partial ejection in rollover events, although no system can prevent all such ejections.

But airbags would not help in many types of collisions, primarily because the occupant's motion is not toward those airbags. See *When Should an Airbag Inflate?* ⇨ 38.

Airbags should never be regarded as anything more than a supplement to seat belts.

What Will You See after an Airbag Inflates?

After frontal and seat-mounted side impact airbags inflate, they quickly deflate, so quickly that some people may not even realize the airbags inflated.

Roof-rail airbags may still be at least partially inflated for some time after they inflate.

Some components of the airbag module may be hot for several minutes. For location of the airbags, see *Where Are the Airbags?* ⇨ 37.

The parts of the airbag that come into contact with you may be warm, but not too hot to touch. There may be some smoke and dust coming from the vents in the deflated airbags. Airbag inflation does not prevent the driver from seeing out of the windshield or being able to steer the vehicle, nor does it prevent people from leaving the vehicle.

Warning

When an airbag inflates, there may be dust in the air. This dust could cause breathing problems for people with a history of asthma or other breathing trouble. To avoid this, everyone in the vehicle should get out as soon as it is safe to do so. If you have breathing problems but cannot get out of the vehicle after an airbag inflates, then get fresh air by opening a window or a door. If you experience breathing problems following an airbag deployment, you should seek medical attention.

The vehicle has a feature that may automatically unlock the doors, turn on the interior lamps and hazard warning flashers, after the airbags inflate. The feature may also activate, without airbag inflation, after an event that exceeds a predetermined threshold.

After turning the vehicle off and then on again, the doors can be locked, the interior lamps can be turned off, the hazard warning flashers can be turned off using the controls

for those features. If any of these systems are damaged in the crash they may not operate as normal.

Warning

A crash severe enough to inflate the airbags may have also damaged important functions in the vehicle, such as the brake and steering systems, etc. Even if the vehicle appears to be drivable after a moderate crash, there may be concealed damage that could make it difficult to safely operate the vehicle.

Use caution if attempting to restart the vehicle after a crash has occurred.

Plug-in vehicles have a high voltage battery and a standard 12-volt battery.

If an airbag inflates or the vehicle has been in a crash, the sensing system may shut down the high voltage system. When this occurs, the high voltage battery is disconnected and the vehicle will not start. Before the vehicle can be operated again, it must be serviced at your dealer.

In many crashes severe enough to inflate the airbag, windshields are broken by vehicle deformation.

- Airbags are designed to inflate only once. After an airbag inflates, you will need some new parts for the airbag system. If you do not get them, the airbag system will not be there to help protect you in another crash. A new system will include airbag modules and possibly other parts. The service manual for the vehicle covers the need to replace other parts.
- The vehicle has a crash sensing and diagnostic module which records information after a crash. See *Vehicle Data Recording and Privacy* ⇨ 239 and *Event Data Recorders* ⇨ 239.
- Let only qualified technicians work on the airbag systems. Improper service can mean that an airbag system will not work properly. See your dealer for service.

Servicing the Airbag-Equipped Vehicle

Airbags affect how the vehicle should be serviced. There are parts of the airbag system in several places around the vehicle. Your dealer and the service manual have information about servicing the vehicle and the airbag system. To purchase a service manual, see *Publication Ordering Information* ⇨ 237.

Warning

For up to 10 seconds after the vehicle is turned off and the battery is disconnected, an airbag can still inflate during improper service. You can be injured if you are close to an airbag when it inflates. Avoid yellow connectors. They are probably part of the airbag system. Be sure to follow proper service procedures, and make sure the person performing work for you is qualified to do so.

Adding Equipment to the Airbag-Equipped Vehicle

Adding accessories that change the vehicle's frame, bumper system, height, front end, or side sheet metal may keep the airbag system from working properly.

The operation of the airbag system can also be affected by changing, including improperly repairing or replacing, any parts of the following:

- Airbag system, including airbag modules, front or side impact sensors, sensing and diagnostic module, or airbag wiring

- Front seats, including stitching, seams or zippers
- Seat belts
- Steering wheel, ceiling trim, or pillar garnish trim

Your dealer and the service manual have information about the location of the airbag modules and sensors, sensing and diagnostic module, and airbag wiring along with the proper replacement procedures.

If the vehicle must be modified because you have a disability and have questions about whether the modifications will affect the vehicle's airbag system, or if you have questions about whether the airbag system will be affected if the vehicle is modified for any other reason, call BrightDrop Fleet Account Care. See *BrightDrop Service Operations and Support with Telecom Relay Services* ⇨ 237.

Airbag System Check

The airbag system does not need regularly scheduled maintenance or replacement. Make sure the airbag readiness light is working. See *Airbag Readiness Light* ⇨ 59.

Caution

If an airbag covering is damaged, opened, or broken, the airbag may not work properly. Do not open or break the airbag coverings. If there are any opened or broken airbag coverings, have the airbag covering and/or airbag module replaced. For the location of the airbags, see *Where Are the Airbags?* ⇨ 37. See your dealer for service.

Replacing Airbag System Parts after a Crash

Warning

A crash can damage the airbag systems in the vehicle. A damaged airbag system may not properly protect you in a crash, resulting in serious injury or even death. To help make sure the airbag systems are working properly after a crash, have them inspected and any necessary replacements made as soon as possible.

If an airbag inflates, you will need to replace airbag system parts. See your dealer for service.

If the airbag readiness light stays on after the vehicle is started or comes on when you are driving, the airbag system may not work properly. Have the vehicle serviced right away. See *Airbag Readiness Light* ⇨ 59.

Child Restraints

Older Children



The label shown below is located on passenger side jump seat belt outboard anchor.

**Warning**

Never secure a child restraint in the front jump seat. Never allow children aged 12 and under to ride in the front jump seat. This vehicle has no seating position intended to accommodate infants or young children. Transport the child in another vehicle.

Children who have not outgrown the booster child seat should not ride in this vehicle.

Older children who have outgrown booster seats should wear the vehicle seat belts. Refer to *How to Wear Seat Belts Properly* ⇨ 30.

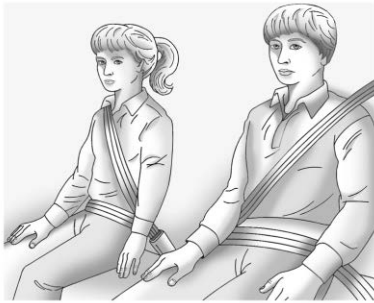

If an older child cannot meet all criteria in the seat belt fit test below, then the booster seat is appropriate for the child, but this vehicle is not suitable for a child restraint seat. Transport the child in another vehicle.

- Sit all the way back on the seat. Do the knees bend at the seat edge? If yes, continue. If no, transport the child in a booster seat in another vehicle.
- Buckle the lap-shoulder belt. Does the shoulder belt rest on the shoulder? If yes, continue. If no, transport the child in a booster seat in another vehicle.
- Does the lap belt fit low and snug on the hips, touching the thighs? If yes, continue. If no, transport the child in a booster seat in another vehicle.

- Can proper seat belt fit be maintained for the length of the trip? If yes, continue. If no, transport the child in a booster seat in another vehicle.

Q: What is the proper way to wear seat belts?

- A:** An older child should wear a lap-shoulder belt and get the additional restraint a shoulder belt can provide. The shoulder belt should not cross the face or neck. The lap belt should fit snugly below the hips, just touching the top of the thighs. This applies belt force to the child's pelvic bones in a crash. It should never be worn over the abdomen, which could cause severe or even fatal internal injuries in a crash.

According to accident statistics, children are safer when properly restrained in a rear seating position.

In a crash, children who are not buckled up can strike other people who are buckled up, or can be thrown out of the vehicle. Older children need to use seat belts properly.

⚠ Warning

Never allow more than one child to wear the same seat belt. The seat belt cannot properly spread the impact forces. In a crash, they can be crushed together and seriously injured. A seat belt must be used by only one person at a time.

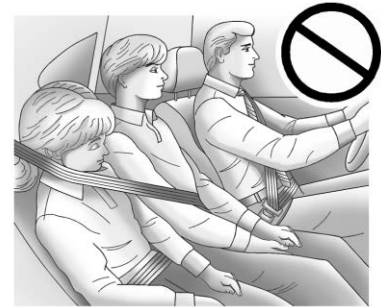

⚠ Warning

Never allow a child to wear the seat belt shoulder belt under both arms or behind their back. A child can be seriously injured by not wearing the lap-shoulder belt properly. In a crash, the child would

(Continued)

Warning (Continued)

not be restrained by the shoulder belt. The child could move too far forward increasing the chance of head and neck injury. The child might also slide under the lap belt. The belt force would then be applied right on the abdomen. That could cause serious or fatal injuries. The shoulder belt should go over the shoulder and across the chest.

**Infants and Young Children****Warning**

Never secure a child restraint in the front jump seat. Never allow children aged 12 and under to ride in the front jump seat. This vehicle has no seating position intended to accommodate infants or young children. Transport the child in another vehicle.

Vehicles equal to or below 4536 kg (10,000 lb) gross vehicle weight rating (GVWR) are equipped with a shoulder belt retractor lock feature on the passenger seat belt. Reference the Certification/Tire Label in the *Vehicle Load Limits* ⇨ 117 of the Driving and Operating section for the vehicle weight classification GVWR.

Pull the seat belt all the way out to activate the shoulder belt retractor lock feature.

Allow the seat belt webbing to fully retract in to deactivate the shoulder belt retractor lock feature.

Everyone in a vehicle needs protection! This includes infants and all other children. Neither the distance traveled nor the age and size of the traveler changes the need, for everyone, to use safety restraints. In fact, the law in every state in the United States and in every Canadian province says children up to some age must be restrained while in a vehicle.

Warning

Never hold an infant or a child while riding in a vehicle. Due to crash forces, an infant or a child will become so heavy it is not possible to hold it during a crash. For example, in a crash at only 40 km/h (25 mph), a 5.5 kg (12 lb) infant will suddenly become a 110 kg (240 lb) force on a person's arms. An infant or child should be secured in an appropriate child restraint and transported in another vehicle.



Where to Put the Restraint

According to accident statistics, children and infants are safer when properly restrained in an appropriate child restraint secured in a rear seating position.

All children aged 12 and under should be secured in a rear seating position. This vehicle does not have rear seats. Never put a rear-facing child restraint in the front.

Warning

Never secure a child restraint in the front jump seat. Never allow children aged 12 and under to ride in the front jump seat. This vehicle has no seating position intended to accommodate infants or young children. Transport the child in another vehicle.

Storage

Storage Compartments

Storage Compartments	46
Instrument Panel Storage	46
Cupholders	47
Overhead Console	47

Luggage/Load Locations

Cargo Area	47
------------------	----

Additional Storage Features

Cargo Tie-Downs	48
Warning Triangle	48
Fire Extinguisher	48
First Aid Kit	49

Storage Compartments

⚠ Warning

Do not store heavy or sharp objects in storage compartments. In a crash, objects may be thrown and cause injury.

Instrument Panel Storage

⚠ Warning

Do not sit, step, or stand on the instrument panel storage areas. You could damage the vehicle.

There are three storage areas on the instrument panel.

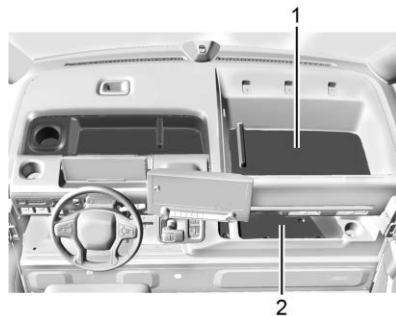

The maximum weight limit for the upper passenger side storage unit (1) is 57.7 kg (125 lb). The maximum weight limit for the lower passenger side storage unit (2) is 20.4 kg (45 lb).

Cupholders



There are three cupholders on the instrument panel.

Overhead Console

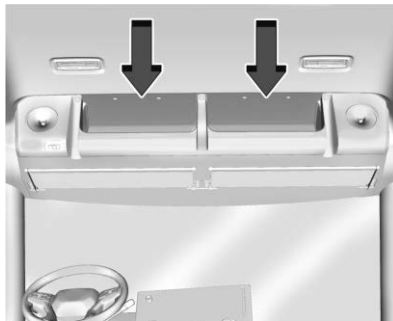

Warning

Do not use either overhead tray to hold an object weighing more than 2 kg (4 lbs) or an object that may fly out or fall down during vehicle operation. Doing so would be dangerous. You and others could be seriously injured.

There is storage in the overhead console.

Luggage/Load Locations

Cargo Area

To access the cargo area, see *Sliding Door (Bulkhead Door)* ⇨ 16.



Warning

Never allow anyone to ride in the cargo area. It is extremely dangerous to ride in the cargo area of a vehicle. In a collision, people riding in these areas are more likely to be seriously injured or killed.

(Continued)

Warning (Continued)

Do not allow people to ride in any area of the vehicle that is not equipped with seats and safety belts. Be sure everyone in the vehicle is in a seat and using a safety belt properly.

Additional Storage Features

Cargo Tie-Downs

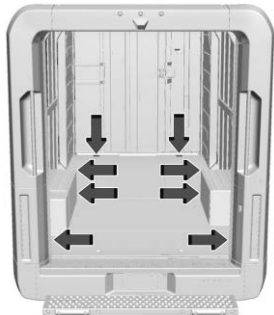

There are eight cargo tie-downs in the rear cargo area.

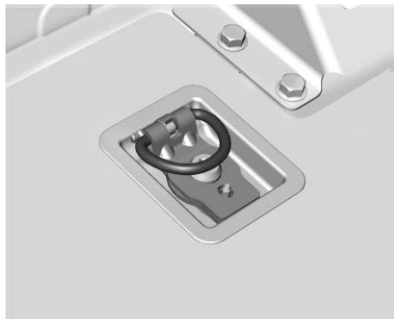

The cargo tie-downs can be used to strap cargo down and keep it from moving inside the vehicle.

The maximum load is 453.59 kg (1000 lb).

Warning Triangle



If equipped, warning triangles are located behind the driver seat, stowed in a bulkhead area. To remove, lift them out of the storage bracket.

Fire Extinguisher

If equipped, this vehicle may have a UL Listed fire extinguisher (minimum rating of 10BC). Please consult the fire extinguisher label for operating instructions. Inspect the fire extinguisher pressure gauge periodically to insure optimal performance.

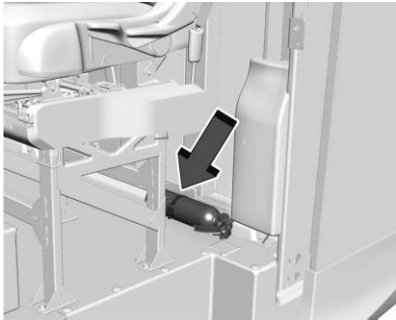

The fire extinguisher is mounted and secured with a vehicle bracket behind the driver seat.

First Aid Kit

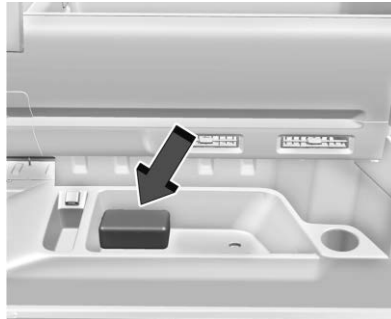

Stow the first aid kit in the lower storage area on the right side of the instrument panel.

Instruments and Controls

Controls

Steering Wheel Adjustment	51
Heated Steering Wheel	51
Horn	51
Pedestrian Safety Signal	51
Windshield Wiper/Washer	52
Clock	54
Power Outlets	54

Warning Lights, Gauges, and Indicators

Warning Lights, Gauges, and Indicators	55
Instrument Cluster	55
Speedometer	58
Odometer	58
Trip Odometer	58
Battery Gauge (High Voltage)	58
Power Indicator Gauge	59
Seat Belt Reminders	59
Airbag Readiness Light	59
Charging System Light (12-Volt Battery)	60
Low State of Charge Light	60
Charge Cord Connected Light	60

Battery Fault Light	60
Propulsion Power is Limited Light	60
Service Vehicle Soon Light (Propulsion System Failure)	61
Brake System Warning Light	61
Electric Parking Brake Light	61
Service Electric Parking Brake Light	61
Antilock Brake System (ABS) Warning Light	62
All-Wheel-Drive Light	62
Automatic Vehicle Hold (AVH) Light	62
Lane Keep Assist (LKA) Light	62
Automatic Emergency Braking (AEB) Disabled Light	63
Vehicle Ahead Indicator	63
Pedestrian Ahead Indicator	63
Traction Off Light	63
StabiliTrak OFF Light	64
Traction Control System (TCS)/StabiliTrak Light	64
Tire Pressure Light	64
Security Light	65
Vehicle Ready Light	65
High-Beam On Light	65
Lamps On Reminder	65
Cruise Control Light	65
Door Ajar Light	66

Information Displays

Charging	66
Energy Information	72
Driver Information Center (DIC)	72

Vehicle Messages

Vehicle Messages	74
Propulsion Power Messages	74
Vehicle Speed Messages	75

Controls

Steering Wheel Adjustment



To adjust the steering wheel:

1. Pull the lever down.
2. Move the steering wheel up or down.
3. Pull or push the steering wheel closer or away from you.
4. Pull the lever up to lock the steering wheel in place.

Do not adjust the steering wheel while driving.

Heated Steering Wheel



 : Press to turn the heated steering wheel on or off. An indicator next to the button is lit when the feature is turned on.

The steering wheel takes about three minutes to start heating.

Automatic Heated Steering Wheel

The heated steering wheel may turn on during a remote start along with the heated seats when it is cold outside. The heated steering wheel indicator may come on in remote start.

The heated steering wheel will turn on when the auto heated seat is activated. The heated steering wheel indicator will display the state of the steering wheel heat.

See *Heated Front Seats* ⇨ 28.

To turn this feature on or off, select Settings > Vehicle > Comfort and Convenience > Heated Steering Wheel > Select ON or OFF.

Horn

Press  on the steering wheel pad to sound the horn.

Pedestrian Safety Signal

The vehicle is equipped with automatic sound generation.

The automatic sound is generated to indicate the vehicle presence to pedestrians.

The sound changes if the vehicle is speeding up or slowing down. It is activated when the vehicle is shifted into a forward gear, N (Neutral), or R (Reverse), up to 35 km/h (22 mph).

Windshield Wiper/Washer



Windshield Wiper with Rainsense (AUTO Shown), If Equipped



Windshield Wiper without Rainsense (INT Shown)

With the vehicle on, move the windshield wiper lever to select the wiper speed.

1X : For a single wipe, briefly move the wiper lever down. For several wipes, hold the wiper lever down.

OFF : Use to turn the wipers off.

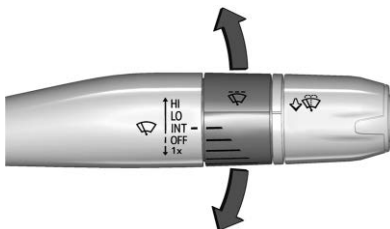

INT : If equipped with intermittent wipers only, move the windshield wiper lever to INT. Turn the band up for more frequent wipes or down for less frequent wipes.

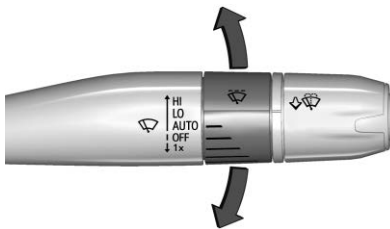

AUTO : If equipped with Rainsense, use this setting for intermittent wipes when Rainsense is disabled, or Rainsense wipes when Rainsense is enabled. For intermittent wipes, move the windshield wiper lever to AUTO, then turn the band up for more

frequent wipes or down for less frequent wipes. If Rainsense is turned on, see “Rainsense” later in this section.

LO : Use for slow wipes.

HI : Use for fast wipes.

 : Pull the windshield wiper lever toward you to spray windshield washer fluid and activate the wipers. The wipers will continue until the lever is released or the maximum wash time is reached. When the windshield wiper lever is released, additional wipes may occur depending on how long the windshield washer has been activated. See *Washer Fluid* ⇨ 175 for information on filling the windshield washer fluid reservoir.

Clear snow and ice from the wiper blades and windshield before using them. If frozen to the windshield, carefully loosen or thaw them. Damaged blades should be replaced. See *Wiper Blade Replacement* ⇨ 180.

 **Warning**

In freezing weather, do not use the washer until the windshield is warmed. Otherwise the washer fluid can form ice on the windshield, blocking your vision.

Warning

Before driving the vehicle, always clear snow and ice from the hood, windshield, washer nozzles, roof, and rear of the vehicle, including all lamps and windows. Reduced visibility from snow and ice buildup could lead to a crash.

Wiper Parking

If the vehicle is turned off while the wipers are on LO, HI, or AUTO with Rainsense turned off, they will immediately stop.

If the windshield wiper lever is then moved to OFF before the driver door is opened or within 10 minutes, the wipers will restart and move to the base of the windshield.

If the vehicle is turned off while the wipers are performing wipes due to windshield washing or Rainsense, the wipers continue to run until they reach the base of the windshield.

Rainsense

If equipped with Rainsense and the feature is turned on, a sensor near the top center of the windshield detects the amount of water

on the windshield and controls the frequency of the windshield wiper based on the current sensitivity setting.

Keep this area of the windshield clear of debris to allow for best system performance.

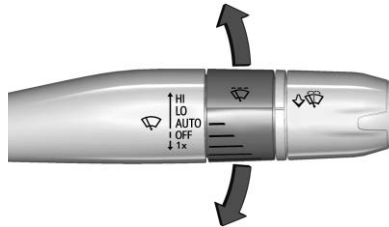

AUTO : Move the windshield wiper lever to AUTO. Turn the band on the wiper lever to adjust the sensitivity.

- Turn the band up for more sensitivity to moisture.
- Turn the band down for less sensitivity to moisture.
- Move the windshield wiper lever out of the AUTO position to deactivate Rainsense.

To turn the Rainsense feature on or off, see “Rain Sense Wipers” under Settings > Vehicle> Comfort and Convenience > Rain Sense Wipers.

Wiper Arm Assembly Protection

When using an automatic car wash, move the windshield wiper lever to OFF. This disables the automatic Rainsense windshield wipers.

With Rainsense, if the vehicle is in N (Neutral) and the vehicle speed is very slow, the wipers will automatically stop at the base of the windshield.

The wiper operation returns to normal when the vehicle is no longer in N (Neutral) or the vehicle speed has increased.

Windshield Washer

 ↑ : Push the paddle marked with the windshield washer symbol at the top of the turn signal lever to spray washer fluid and activate the wipers. The wipers will continue until the paddle is released or the maximum wash time is reached. When the paddle is released, additional wipes may occur depending on how long the windshield washer had been activated. See *Washer Fluid* ⇨ 175 for information on filling the windshield washer fluid reservoir.

Clock

Set the time and date using the infotainment system. See "Time/Date" under *Settings* ⇨ 101.

Power Outlets

12-Volt Direct Current

The accessory power outlet can be used to plug in electrical equipment, such as a mobile phone or MP3 player. The accessory power outlet only works with the vehicle turned on.



The vehicle has an accessory power outlet on the lower center stack below the climate control.

Open the cover to access and replace when not in use.

Caution

Leaving electrical equipment plugged in for an extended period of time while the vehicle is off will drain the battery. Always unplug electrical equipment when not in use and do not plug in equipment that exceeds the maximum 20 amp rating.

Certain accessory power plugs may not be compatible with the accessory power outlet and could overload vehicle or adapter fuses. If a problem is experienced, see your dealer.

When adding electrical equipment, be sure to follow the proper installation instructions included with the equipment. See *Add-On Electrical Equipment* ⇨ 168.

Caution

Hanging heavy equipment from the power outlet can cause damage not covered by the vehicle warranty. The power outlets are designed for accessory power plugs only, such as cell phone charge cords.

110-Volt Alternating Current

The power outlets can be used to plug in electrical equipment that uses a maximum limit of 400 watts. Open the cover to access the outlet.

There are two 110-Volt power outlets:



Upper Instrument Panel

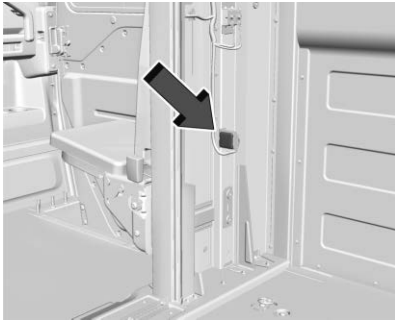

Rear Cargo Area

When the ignition is on, power is supplied to the outlets. One power outlet can be used with electrical equipment that uses a maximum of 400 watts. If both outlets are being used, 400 watts will be shared between the outlets. Ensure that all connected devices do not exceed 400 watts.

An indicator light on the outlet illuminates when power is provided to the outlet and no system fault is detected. The outlets will not operate when the ignition is off or the plug is not fully seated into the outlet.

If equipment is connected using more than 400 watts or a system fault is detected, a protection circuit shuts off the power supply and the indicator light turns off.

Do not use a power outlet with a missing or damaged cover.

The power outlet is not designed for the following, and may not work properly if they are plugged in:

- Equipment with high initial peak wattage, such as compressor-driven refrigerators and electric power tools
- Other equipment requiring an extremely stable power supply, such as microcomputer-controlled electric blankets and touch sensor lamps
- Medical equipment

Warning Lights, Gauges, and Indicators

Warning lights and gauges can signal that something is wrong before it becomes serious enough to cause an expensive repair or replacement. Paying attention to the warning lights and gauges could prevent injury.

Some warning lights come on briefly when the propulsion system is started to indicate they are working. When one of the warning lights comes on and stays on while driving, or when one of the gauges shows there may be a problem, check the section that explains what to do. Waiting to do repairs can be costly and even dangerous.

Instrument Cluster

The instrument cluster displays a preview of information including electric range, charging, odometer, and battery status when the driver door is opened, before starting the vehicle. This preview dismisses after starting the vehicle or soon after closing the driver door.

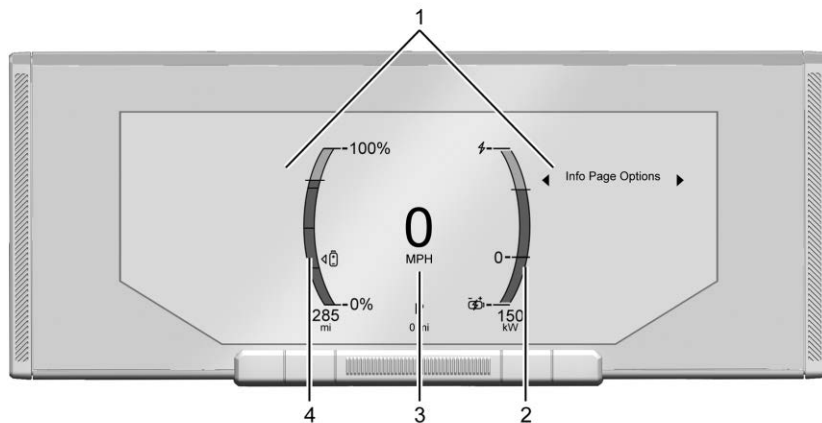

English Cluster Shown, Metric Similar

1. *Driver Information Center (DIC)* ⇨ 72
2. *Power Indicator Gauge* ⇨ 59
3. *Speedometer* ⇨ 58
4. *Battery Gauge (High Voltage)* ⇨ 58

Cluster Menu

There is interactive display areas in the instrument cluster. Locations may vary by the selected display layout.

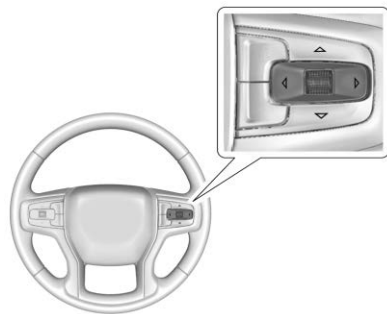

Use the right steering wheel control to open and scroll through the different items and displays.

Press < or > to access the cluster applications. Use the thumbwheel to scroll through the list of available features within the applications. Not all applications or features will be available on all vehicles.

- Left Side Info
- Vehicle info. This is where the Driver Information Center (DIC) displays can be viewed. See *Driver Information Center (DIC)* ⇨ 72.

- Audio
- Navigation
- Phone
- Options

Left Side Info

Information Displayed here can be customized from the Options menu. See "Options" below.

Compass : If equipped, shows the direction the vehicle is heading.

Time & Temperature : Displays the current time and outside air temperature.

Tire Pressure : Shows the approximate pressures of all four tires. Tire pressure is displayed in either kilopascal (kPa) or in pounds per square inch (psi). If the pressure is low, the value for that tire is shown in amber.

None : Displays the info area as empty.

Audio

Browse for music, select from the favorites, or change the audio source. Use the thumbwheel to change the station or go to the next or previous track.

Navigation

If there is an active route, the Turn-by-Turn directions will appear on the Navigation Page, if there is no active route a compass will be displayed.

Phone

If there is no active phone call, view recent calls.

Options

Use the thumbwheel to scroll through items in the Options menu.

Left Side Info : Press the thumbwheel to select the items to be displayed in the display areas. See "Left Side Info" previously in this section.

Info Page Options : Press the thumbwheel to select the items to be displayed in the Info app. See *Driver Information Center (DIC)* ⇨ 72.

Units : Choose US or metric units by pressing the thumbwheel while the desired item is highlighted.

Speed Warning : The Speed Warning display allows the driver to set a speed that they do not want to exceed. To set the Speed Warning press the thumbwheel when Speed

Warning is displayed. Use the thumbwheel to adjust the value and press to set the speed.

Once the speed is set, this feature can be turned off by pressing the thumbwheel while viewing this page. If the selected speed limit is exceeded, a pop-up warning is displayed with a chime.

Speed Limit Sign Display : Shows sign information, which comes from a roadway database in the onboard navigation, if equipped.

Remote Key Relearn : If equipped, this feature allows for the vehicle to relearn remote keys.

See "Programming with a Recognized Remote Key" under *Remote Key Operation* ⇨ 7.

Software Information : Displays open source software information.

Reset To Defaults : Allows the driver to reset to default settings.

Traction & Stability : If equipped, displays the status of the Traction (TSC) and Stability (ESC) control systems. To turn the Traction

Control System (TCS) on or off, choose Traction. See *Traction Control/Electronic Stability Control* ⇨ 131.

Speedometer

The speedometer shows the vehicle speed in either kilometers per hour (km/h) or miles per hour (mph).

Odometer

The odometer shows how far the vehicle has been driven, in either kilometers or miles.

Trip Odometer

The trip odometer shows how far the vehicle has been driven since the trip odometer was last reset.

The trip odometer is accessed and reset through the Driver Information Center (DIC). See *Driver Information Center (DIC)* ⇨ 72.

Battery Gauge (High Voltage)

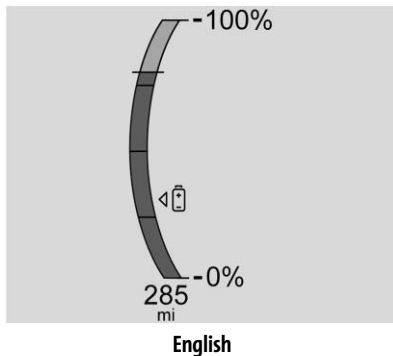
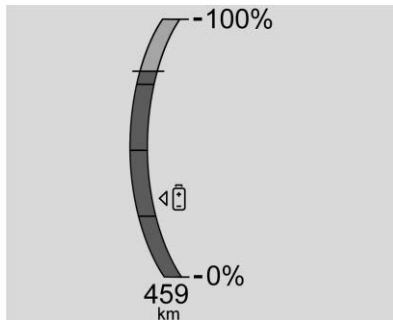

This displays the high voltage battery state of charge. The value at the bottom is an estimate of how far the vehicle can be driven on the remaining charge based on recent driving habits, conditions, and HVAC usage.

The fill bars shown inside of the gauge indicate the percentage range as estimated from current vehicle conditions and climate settings. The range estimate on the bottom also may be affected by climate settings, current vehicle conditions and ambient conditions. Estimated range may increase and decrease based on climate control energy consumption.

Driving aggressively through hard acceleration and/or braking events, excessive HVAC usage, using heated or cooled seats, battery preconditioning, and performance modes can affect vehicle range estimates.

When the high voltage battery state of charge level gets low, the gauge will change color to amber. When the charge is very low the gauge will flash, and the estimated range value on the bottom will change to LOW. Additional alerts may display and a sound may also be heard at low state of charge.

Power Indicator Gauge

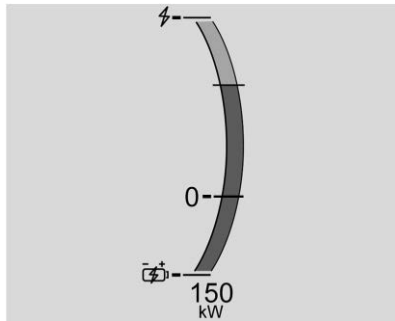

The power indicator gauge is in the center of the display to the right of the speedometer.

This gauge displays the instantaneous charge and consumption power of the high voltage battery. Maximum power consumption is available when the high voltage battery is fully charged. During normal operation, a slight reduction in consumption power may occur as the high voltage battery state of charge decreases.

Regenerative Braking

When regenerative braking is active, the regen battery icon appears green and will show a blue tail on the fill bar. The power indicator gauge value shows the amount of instantaneous power being regenerated.

Regenerative Power Limited

Regenerative power may be limited when the high voltage battery is near full charge or cold. This will affect the vehicle's maximum regenerative braking power.

Seat Belt Reminders

Driver Seat Belt Reminder Light

There is a seat belt reminder light on the instrument cluster.



When the vehicle is started, this light flashes and a chime may come on to remind the driver to fasten their seat belt. Then the light stays on solid until the belt is buckled.

This cycle may continue several times if the driver remains or becomes unbuckled while the vehicle is moving.

If the driver seat belt is buckled, neither the light nor the chime comes on.

Airbag Readiness Light

This light shows if there is an electrical problem with the airbag system. It is located in the instrument cluster. The system check includes the airbag sensor(s), the pretensioners (if equipped), the airbag modules, the wiring, and the crash sensing and diagnostic module. For more information on the airbag system, see *Airbag System* ⇨ 36.



The airbag readiness light comes on for several seconds when the vehicle is started. If the light does not come on then, have it fixed immediately.

Warning

If the airbag readiness light stays on after the vehicle is started or comes on while driving, it means the airbag system might not be working properly. The airbags in the vehicle might not inflate in a crash, or they could even inflate without a crash. To help avoid injury, have the vehicle serviced right away.

If there is a problem with the airbag system, a Driver Information Center (DIC) message may also come on.

Charging System Light (12-Volt Battery)



The charging system light comes on briefly when the vehicle is started, as a check to show the light is working.

If the light stays on, or comes on while driving, there could be a problem with the electrical charging system. Have it checked by your dealer. Driving while this light is on could drain the 12-volt battery.

If a short distance must be driven with the light on, be sure to turn off all accessories, such as the radio. Find a safe place to stop the vehicle.

Low State of Charge Light



This light comes on when the vehicle state of charge is low. Proceed to a charging station to charge the vehicle.

Charge Cord Connected Light



If equipped, this light comes on when a charge cord is connected to the vehicle.

Battery Fault Light



This light indicates a fault with the high voltage battery. A message may also display in the Driver Information Center (DIC). See your dealer for service.

Propulsion Power is Limited Light



These lights display when the vehicle propulsion power is limited, which may affect the vehicle's ability to accelerate. The vehicle may be driven while these lights are on, but maximum acceleration and speed may be limited.

Service Vehicle Soon Light (Propulsion System Failure)



This light comes on if a condition exists that may require the vehicle to be taken in for service.

If the light comes on, take the vehicle to your dealer for service as soon as possible.

Brake System Warning Light



BRAKE

Metric

English

This light comes on briefly when the vehicle is turned on to show that the light is working. If it does not come on then, have it fixed so it will be ready to warn you if there is a problem.

If the light comes on and stays on, there is a brake problem. Have the brake system inspected right away. This light may come on if the brake fluid is low. See *Brake Fluid* ⇨ 177.

If the light comes on while driving, pull off the road and stop carefully. The brake pedal might be harder to push, or the brake pedal may go closer to the floor. It could take longer to stop. If the light is still on, have the vehicle towed for service. See *Transporting a Disabled Vehicle* ⇨ 218.

Warning

The brake system might not be working properly if the brake system warning light is on. Driving with the brake system warning light on can lead to a crash. If the light is still on after the vehicle has been pulled off the road and carefully stopped, have the vehicle towed for service.

Electric Parking Brake Light



PARK

Metric

English

This light comes on when the parking brake is applied. If the light continues flashing after the parking brake is released, or while driving, there is a problem with the Electric Parking Brake system. A message may also display in the Driver Information Center (DIC).

If the light does not come on, or remains flashing, see your dealer.

Service Electric Parking Brake Light



This light should come on briefly when the vehicle is turned on. If it does not come on, have it fixed so it will be ready to warn if there is a problem.

If this light stays on or comes on while driving, there is a problem with the Electric Parking Brake (EPB). Take the vehicle to a dealer as soon as possible. In addition to the parking brake, other safety functions that utilize the EPB may also be degraded. A message may also display in the Driver Information Center (DIC). See *Electric Parking Brake* ⇨ 129.

Antilock Brake System (ABS) Warning Light



This light comes on briefly when the vehicle is turned on to show that the light is working. If it does not come on then, have it fixed so it will be ready to warn you if there is a problem.

If the ABS warning light stays on, or comes on again while driving, the vehicle needs service. A chime may also sound when the light stays on.

If the ABS warning light is the only light on, the vehicle has regular brakes, but ABS is not functioning.

If both the ABS warning light and the brake system warning light are on, ABS is not functioning and there is a problem with the regular brakes. See your dealer for service.

See *Brake System Warning Light* ⇨ 61.

All-Wheel-Drive Light



This light is amber when the electric all-wheel drive (eAWD) system is limited, and will turn off when the system is working normally.

If this light is red, there may be a malfunction. See your dealer.

See *All-Wheel Drive* ⇨ 128.

Automatic Vehicle Hold (AVH) Light



This light comes on when AVH is actively holding the vehicle. See *Automatic Vehicle Hold (AVH)* ⇨ 130.

Lane Keep Assist (LKA) Light



If equipped, the Lane Keep Assist Light may display the following colors:

- Blank: LKA is disabled.
- White: Appears when the vehicle starts. A steady white light indicates that LKA is not ready to assist.

- Green: Appears when LKA is turned on and ready to assist. LKA will gently turn the steering wheel if the vehicle approaches a detected lane marking.
- Amber: Appears when LKA is active. The light flashes amber as a Lane Departure Warning (LDW) alert to indicate that the lane marking has been unintentionally crossed. If the system detects you are steering intentionally (to pass or change lanes), the LDW alert may not display.

LKA will not assist or alert if the turn signal is active in the direction of lane departure, or if LKA detects that you are accelerating, braking, or actively steering. See *Lane Keep Assist (LKA)* ⇨ 158.

Automatic Emergency Braking (AEB) Disabled Light



This indicator displays when you turn off Automatic Emergency Braking (AEB) or Front Pedestrian Braking (FPB).

This indicator will also display if AEB or FPB is unavailable due to malfunction, weather conditions, or if the windshield is not clean.

See *Automatic Emergency Braking (AEB)* ⇨ 153.

See *Front Pedestrian Braking (FPB) System* ⇨ 154.

Vehicle Ahead Indicator



If equipped, this indicator will display green when a vehicle is detected ahead and amber when you are following a vehicle ahead much too closely.

See *Forward Collision Alert (FCA) System* ⇨ 151.

Pedestrian Ahead Indicator



If equipped, this indicator will display amber when a nearby pedestrian is detected in front of the vehicle.

See *Front Pedestrian Braking (FPB) System* ⇨ 154.

Traction Off Light



This light comes on briefly when the vehicle is turned on to show that the light is working. If it does not come on then, have it fixed so it will be ready to warn you if there is a problem.

The traction off light comes on when the Traction Control System (TCS) has been turned off. For Front Wheel Drive (FWD) vehicles, to turn TCS off and on, see *Traction Control/Electronic Stability Control* ⇨ 131.

If TCS is off, wheel slip during acceleration is not limited unless necessary to help protect the driveline from damage. Adjust driving accordingly.

StabiliTrak OFF Light



This light comes on briefly when the vehicle is turned on to show that the light is working. If it does not come on then, have it fixed so it will be ready to warn you if there is a problem.

This light comes on when the StabiliTrak/Electronic Stability Control (ESC) system is turned off.

If ESC and TCS are off, the systems do not assist in controlling the vehicle. Adjust driving accordingly.

Traction Control System (TCS)/ StabiliTrak Light



This light comes on briefly when the vehicle is turned on to show that the light is working. If it does not come on then, have it fixed so it will be ready to warn you if there is a problem.

If the light is on and not flashing, the TCS and potentially the StabiliTrak/ESC system are not fully operational and may not assist in maintaining control. Adjust driving accordingly. If the condition persists, see your dealer as soon as possible. A Driver Information Center (DIC) message may display.

The light flashes when the TCS and/or the StabiliTrak/ESC system is actively working.

See *Traction Control/Electronic Stability Control* ⇨ 131.

Tire Pressure Light



If equipped with the Tire Pressure Monitor System (TPMS), this light comes on briefly when the vehicle is started. It provides information about tire pressures and the TPMS.

When the Light Is On Steady

This indicates that one or more of the tires are significantly underinflated.

A Driver Information Center (DIC) tire pressure message may also display. Stop as soon as possible, and inflate the tires to the pressure value shown on the Tire and Loading Information label. See *Tire Pressure* ⇨ 194.

When the Light Flashes First and Then Is On Steady

If the light flashes for about a minute and then stays on, there may be a problem with the TPMS. If the problem is not corrected,

the light will come on every time the vehicle is started. See *Tire Pressure Monitor Operation* ⇨ 196.

Security Light



The security light should come on briefly as the vehicle is started. If it does not come on, have the vehicle serviced by your dealer. If the system is working normally, the indicator light turns off.

If the light stays on and the vehicle does not start, there could be a problem with the theft-deterrent system. See *Immobilizer Operation* ⇨ 21.

Vehicle Ready Light



The vehicle ready light comes on whenever the vehicle is parked and ready to be driven.

High-Beam On Light



This light comes on when the high-beam headlamps are in use. See *Headlamp High/Low-Beam Changer* ⇨ 77.

IntelliBeam Light



If equipped, this light comes on when the IntelliBeam system is enabled. See *Exterior Lamp Controls* ⇨ 76.

Lamps On Reminder



This light comes on when the exterior lamps are in use, except when only the Daytime Running Lamps (DRL) are active. See *Exterior Lamp Controls* ⇨ 76.

Cruise Control Light



The cruise control light is white when the cruise control is on and ready, and turns green when the cruise control is set and active.

See *Cruise Control* ⇨ 133.

Adaptive Cruise Control Light



This light is white when the Adaptive Cruise Control (ACC, if equipped) is on and ready, and turns green when the ACC is set and active.

See *Adaptive Cruise Control* ⇨ 134.

Door Ajar Light



This light comes on when a door is open or not securely latched. Before driving, check that all doors are properly closed.

Information Displays

Charging

Important Information about Electric Vehicle Charging

- Charging an electric vehicle can stress a building's electrical system more than a typical household appliance.
- Charge cord limits can vary from vehicle to vehicle, and increased charging rates can stress a building's electrical system.
- Before plugging into any electrical outlet, have a qualified electrician inspect and verify the electrical system (electrical outlet, wiring, junctions, and protection devices) for heavy-duty service at a 12 amp continuous load.
- Electrical outlets may wear out with normal usage or may be damaged over time, making them unsuitable for electric vehicle charging.
- Check the electrical outlet/plug while charging and discontinue use if the electrical outlet/plug is hot, then have the electrical outlet serviced by a qualified electrician.
- When outdoors, plug into an electrical outlet that is weatherproof while in use.

- Mount the charging cord to reduce strain on the electrical outlet/plug.
- Do not place the charge cord in a position where it is expected to be submerged in water.

Danger

Improper use of portable electric vehicle charge cords may cause a fire, electrical shock, or burns, and may result in damage to property, serious injury, or death.

- Do not use extension cords, multi-outlet power strips, splitters, grounding adapters, surge protectors, or similar devices.
- Do not use an electrical outlet that is worn or damaged, or will not hold the plug firmly in place.
- Do not use an electrical outlet that is not properly grounded.
- Do not use an electrical outlet that is on a circuit with other electrical loads.

Energy App

The Energy app gives you access to features that will help you better understand and control how the vehicle manages energy. Along with providing a central location to determine and review your charging preferences, the Energy app offers live information on how the vehicle is using energy.

To launch the Energy app from the infotainment home screen, touch the Energy icon. There are four selections to choose from: Charging, Schedule, Energy Usage, and Settings. When you launch Energy for the first time, the Charging screen will display.

Charging

To view the current charging status in the infotainment display, touch Charging.

On the Charging screen, there is a range of information associated with the next Charging session, as well as the ability to specify when you would like to charge the vehicle. The choices available to charge are Charge Now or Charge Later.

To create a charge schedule see “Creating a Charge Schedule” under “Schedule” below. The Charging screen shows and allows you to determine how the vehicle charges the next time it is plugged in.

Charge Now

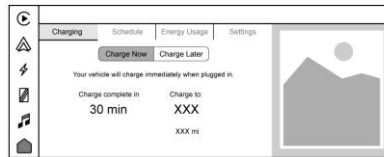

Charge Now is the default charging mode for your vehicle. The vehicle begins charging immediately when it is plugged in and authenticated at the charging location.

With Charge Now selected, the Charging screen displays:

- Text explaining that the vehicle will charge immediately when plugged in.
- Charge Level: The percentage to which you would like the vehicle to charge.
- Charge Complete by/in: The estimated time at which the vehicle will reach the desired Charge Level.
- An estimate of the vehicle's range upon completing the charging session.

The default charge level is 100% when plugged in. To set a different charge level, touch the percentage shown under Charge Level to display the Charge Level dialog.

Warning

Do not charge your vehicle's battery above an 80% charge if you are going to drive down long, steep grades such as mountain passes. This provides room in the battery for regenerative braking to supplement your conventional brakes during the descent.

See *Hill and Mountain Roads* ⇨ 115 for important information about driving on grades.

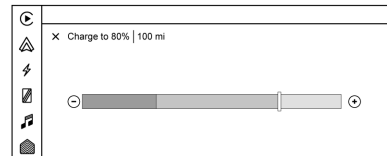

The Charge Level dialog displays:

- The Charge Level Gauge with a color-filled portion displaying the vehicle's current charge level. Use **⊖** and **⊕** or drag the marker to adjust the desired Charge Level.

- Range: An estimate of the vehicle's range upon reaching the Charge Level specified in this dialog.
- An **X** allowing you to close the Charge Level dialog. Settings made here are automatically saved when the dialog is exited.

To lower the desired Charge Level, drag the Charge Level marker to the left, and to increase it drag the marker to the right. The Charge Level percentage appears above your finger, updating in 5% increments as you drag. The Range estimate updates once the marker is released at the desired Charge Level. To optimize battery health, the minimum allowable Charge Level is determined by the vehicle. Touch **X** to exit the Charge Level dialog and accept the changes. When the dialog closes, the charging information listed on the Charging screen is updated to reflect any changes made.

Charge Later

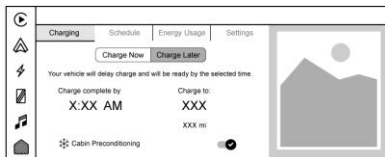

Instead of charging immediately to a desired Charge Level, you may choose to delay the charge to the vehicle and have it complete by your desired departure time. This may be a more economical choice and a more efficient use of energy when charging at home. To use this mode, touch the Charge Later tab from the Charging screen.

With Charge Later selected, the Charging screen displays:

- Text explaining that your vehicle will delay the planned charge to be ready by the time specified.
- Charge Complete by: The time at which the vehicle will reach the desired Charge Level.
- Charge Level: The percentage to which you would like the vehicle to charge.
- An estimate of the vehicle's range upon completing the charging session.

- Cabin Preconditioning: Allows the vehicle to heat or cool the cabin to your desired temperature using energy from the charger. This means energy from the battery is not used to condition the cabin, ensuring the vehicle gets the greatest range from the charging session. Cabin preconditioning happens at the end of the charge, and right before the departure time.

To set the time desired for the vehicle to complete charging, touch the time listed under Charge Complete By. This will display the Charge Complete By dialog.



The Charge Complete By dialog displays:

- A time selector that allows you to specify the hour, the minutes in 15 minute increments at which the vehicle will reach the desired Charge Level.

- An **X** allowing you to close the Charge Complete By dialog. Settings made here are automatically saved when the dialog is exited.

Drag the appropriate sections of the time selector to set the Charge Complete By time. Touch **X** to exit the Charge Complete By dialog and accept the changes made. When the dialog closes, the charging information listed on the Charging screen will update to reflect any changes made. If the time specified does not allow the vehicle enough time to reach the desired Charge Level, a message displays and you can choose to alter either Charge Complete By time or desired Charge Level.

To adjust desired Charge Level in Charge Later mode, see “Charge Now” earlier in this section.

Setting the Cabin Preconditioning preference:

Touch the switch to turn on Cabin Preconditioning. Cabin Preconditioning temperature can be set in Settings, or by touching Cabin Preconditioning on this screen.

Active Charging

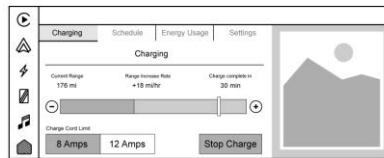

During an active charging session, the Charging screen displays and continuously updates the following items:

- Text indicating the vehicle’s current charging status.
- Current Range: The range the vehicle is capable of driving at the current charge level.
- Range Increase Rate: How much range is accumulating per hour of charging.
- Charge Complete at/in: The estimated time at which the vehicle will reach the desired Charge Level.
- The Charge Level Gauge with a portion displaying the vehicle’s current charge level. Use **–** and **+** or drag the white marker to adjust the desired Charge Level.

To update the desired Charge Level for the active charging session, drag the marker on the Charge Level Gauge or touch the **–** and **+**.

Touching the Stop Charge button at any time ends the active charging session and presents a summary of the current vehicle Range, Charge Level, and amount of Range Gained during the charging session. For information on beginning a charging session, see *Plug-In Charging* ⇨ 160.

For Level 1 chargers, you can also select the appropriate Charge Cord Limit of either 8 amps or 12 amps. This determines how much current can flow from an electrical outlet to the vehicle battery. It also ensures proper charge time estimates.

When the Charge Cord Limit is changed from 8 amps to 12 amps on a 120V circuit a notification is displayed.

If no Home Charge Location is set, the Level 1 Cord Limit will revert to 8 amps every time the vehicle is shifted out of (P) Park.

Range and charge time estimates fluctuate depending on a number of factors such as Charge Cord Level/Limit, battery temperature, and outside air temperature. To learn more about the vehicle battery see *Plug-In Charging* ⇨ 160.

The peek-in charging screen can be used to monitor your vehicle's charge status remotely, see *Instrument Cluster* ⇨ 55.

DC Fast Charging

The vehicle will immediately begin charging when plugged into a DC fast charging station. While DC Fast Charging, the vehicle will bypass any schedule or departure time selection. See *Plug-In Charging* ⇨ 160.

Schedule

The Energy app's Schedule feature allows a custom charging plan to be set for each day of the week. When the vehicle is plugged in at the Home Charge Location, the Schedule feature will automatically charge to the desired Charge Level and precondition the cabin by the time set in the Schedule. This feature acts as a more customizable Charge Later setting than the one on the Charging screen.

Creating a Schedule

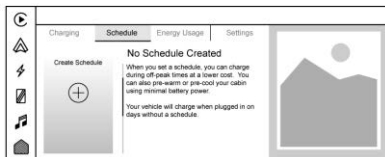

To create a Schedule, touch the Create Schedule card on the left. If there is no Home Charge Location set you will be prompted to create one.

The Charging Schedule dialog displays:

- Toggles for each day of the week.
- Charge to: A value selector for setting the desired Charge Level.
- Complete by: A time selector for setting the time the vehicle will reach the desired Charge Level.
- Cabin Preconditioning: Allows the vehicle to heat or cool the cabin to the desired temperature by using energy from the charger.
- An **X** allowing you to close the Charging Schedule dialog.
- Save & Close button: Applies any changes made and exits the dialog.

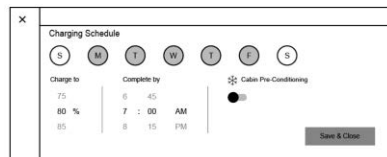

Days can be assigned to the Schedule. Days of the week represented by their first letter in circular toggles. Touching each toggle illuminates the graphic, confirming that day is assigned that to the Schedule. Touching a second time unassigns days from this Schedule, dimming the toggle once again. Select all days to adhere to the settings in this Schedule. If there are multiple charge schedules, days must be unassigned from their current Schedule before they can be assigned to a new one.

Once completed with the charging Schedule, touch the Save & Close button to finish creating the schedule.

On days that are not assigned a Schedule, the vehicle will begin charging to 100% as soon as it is plugged in, unless otherwise specified on the Charging screen.

Home Charge Schedule can be turned ON or OFF. To enable or disable all charging Schedules, touch the toggle switch next to Home Charge Schedule on the Schedule screen.

Modifying and Deleting Charge Schedules



To modify a Schedule, touch the card on the Schedule screen. This will open a dialog. Make the desired changes and then touch the Save & Close button when finished. To delete the Schedule, simply touch the Delete Schedule button, at which point you will be prompted to confirm your decision.

Charge Settings

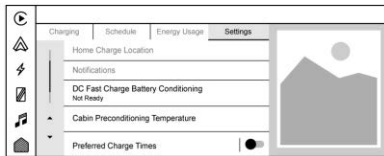

To view and change the Charge Settings, touch Settings. Use the arrows to scroll through the list, or hold and drag the list.

This screen allows preferences to be set with regards to how the vehicle charges. Touching any item will display options for specifying their behavior.

The Settings screen displays:

Home Charge Location

With a Home Charge Location set, the vehicle can determine whether it is plugged in at home, and will charge according to any existing schedules. The Home Charge Location can be changed or deleted at this screen.

The wireless service and GPS satellite technologies must be available and operating for features to function properly. These systems may not operate if the battery is disconnected, or if the vehicle has been off for an extended period of time. If GPS is unavailable, a message displays on the infotainment screen. GPS functionality may resume after the next time you drive the vehicle.

Notifications

This section contains on/off preferences for multiple notifications triggered during the Charging session.

Charge Status Feedback : Provides an audible notification through horn chirps that accompany changes in the charging status.

Charge Power Loss Alert : When on, your vehicle will chirp for an extended period of time if charging power is cut off.

DC Fast Charge Battery Conditioning

Adjusts the battery to the optimal temperature for quicker DC Fast Charging. This should be done before charging at a DC Fast Charger.

Depending on the outside and battery temperature, battery conditioning could be as long as one hour.

While en route using Google Maps, DC Fast Charge Conditioning happens automatically if a DC Fast Charge station has been added to the route.

Cabin Preconditioning Temperature

Allows for the preferred cabin temperature to be set. During your next charging session, the vehicle cabin is warmed or cooled to

this temperature if Preconditioning is set to ON in either the Charge Later screen, or in an active Schedule.

Preferred Charge Times

Allows preferred charge time windows to be enabled for the Home Charge Location during both weekday and weekend scheduled or delayed charging sessions. This allows for charging at a lower cost by charging during the electrical provider's off-peak period. The vehicle will use these times to reach the desired Charge Level by the scheduled time. If the vehicle cannot reach the desired charge level within these times, it will charge as needed outside of this schedule.

Energy Information

Energy Usage

To view Energy Usage, touch Energy Usage on the infotainment display.

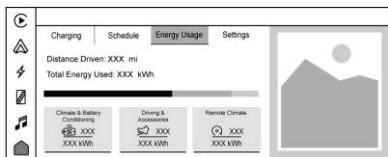

This screen displays how energy is being used for the current drive since the last time the vehicle was started.

The Energy Usage screen displays:

Distance Driven : The distance of your current Trip.

Total Energy Used : The amount of energy used during your current Trip, shown in Kilowatt Hours (kWh).

i : For displaying more information about your vehicle's Energy Usage.

Energy Usage Bar Diagram : A visual representation of the percentage of total energy being used by each Energy Usage Category.

Energy Usage Categories : Climate & Battery Conditioning, Driving & Accessories, and Remote Climate.

Tap **i** or any Energy Usage Category to learn more about how your vehicle uses energy from the battery.

Driver Information Center (DIC)

The DIC is displayed in the instrument cluster. It shows the status of many vehicle systems. The controls for the DIC are on the right steering wheel control. See *Instrument Cluster* ⇨ 55.

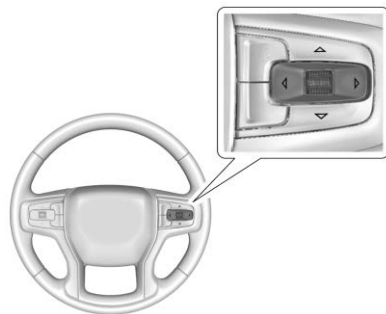

△ or ▽ : Move the thumbwheel up or down in a list.

◀ or ▶ : Press to move between the interactive display zones in the cluster.

Thumbwheel : Press to open a menu or select a menu item. Press and hold to reset values on certain screens.

DIC Info Page Options

The info pages on the DIC can be turned on or off through the Options menu.

1. Press \triangleleft to access the cluster applications.
2. Move the thumbwheel up or down through the list of available applications.
3. Press the thumbwheel to select the application, then press \triangleright to enter the application menu.
4. Move the thumbwheel \triangle or ∇ to move through the list of possible information displays.
5. Press the thumbwheel while an item is highlighted to select or deselect that item.

When an item is selected, a checkmark will appear next to it.

DIC Info Pages

The following is the list of all possible DIC info page displays. Some may not be available for your particular vehicle. Some items may not be turned on by default but can be turned on through the Options app. See "DIC Info Page Options" earlier in this section.

Drive Summary : Displays the current distance traveled, in either kilometers (km) or miles (mi).

It also includes the Average Efficiency. Average Efficiency shows the approximate average kilometers per kilowatt hour kWh (km/kWh) or miles per kilowatt hour kWh(mi/kWh). This number only reflects the approximate average electrical energy economy that the vehicle has at that moment, and changes as driving conditions change.

The timer shows the time in the current drive cycle.

All values in the Drive Summary are automatically reset each time the vehicle is started.

Trip 1 or Trip 2 and Average Efficiency : The Trip display shows the current distance traveled, in either kilometers (km) or miles (mi), since the trip odometer was last reset.

The Average Efficiency shows the approximate average kilometers per kilowatt hour kWh (km/kWh) or miles per kilowatt hour kWh(mi/kWh). This number is calculated based on the number of km/kWh or mi/kWh recorded since the last time this

menu item was reset. This number only reflects the approximate average electrical energy economy that the vehicle has at that moment, and changes as driving conditions change.

The values can be reset by pressing and holding the thumbwheel while either the Trip 1 or the Trip 2 display is active.

Timer : The display shows the amount of time that has passed since the timer was last reset. To start/stop the timer, press the thumbwheel to access the menu while this display is active. To reset the timer to zero, press the thumbwheel while the menu for this display is active.

Tire Pressure : Shows the approximate pressures of all four tires. Tire pressure is displayed in either kilopascal (kPa) or in pounds per square inch (psi). If the pressure is low, the value for that tire is shown in amber. Pressing and holding the thumbwheel will display a series of alerts for Tire Manual Learning.

Driver Assistance : If equipped, shows information for Adaptive Cruise Control (ACC), Follow Distance, Lane Keep Assist (LKA) and Forward Collision Alert (FCA).

Energy Usage : Shows energy usage of the Driving, Remote Climate, Climate and Conditioning vehicle systems as percentages of overall vehicle energy use.

Blank Page : No information is displayed in the cluster info display areas.

Info Page Options : Press the thumbwheel to select the items to be displayed in the Info app.

Vehicle Messages

Messages displayed on the DIC indicate the status of the vehicle or some action that may be needed to correct a condition. Multiple messages may appear one after another.

The messages that do not require immediate action can be acknowledged and cleared by pressing the thumbwheel. The messages that require immediate action cannot be cleared until that action is performed.

All messages should be taken seriously; clearing the message does not correct the problem.

If a SERVICE message appears, see your dealer.

Follow the instructions given in the messages. The system displays messages regarding the following topics:

- Service Messages
- Fluid Levels
- Vehicle Security
- Brakes
- Ride Control Systems
- Driver Assistance Systems
- Cruise Control
- Lighting and Bulb Replacement
- Wiper/Washer Systems
- Doors and Windows
- Seat Belts
- Airbag Systems
- Propulsion
- Tire Pressure
- Battery
- Steering

Propulsion Power Messages

REDUCED ACCELERATION DRIVE WITH CARE

This message displays when the vehicle's propulsion power is reduced. A reduction in propulsion power can affect the vehicle's

ability to accelerate. If this message is on, but there is no observed reduction in performance, proceed to your destination. Under certain conditions, the performance may be reduced the next time the vehicle is driven. The vehicle may be driven while this message is on, but maximum acceleration and speed may be reduced. Anytime this message stays on, or displays repeatedly, the vehicle should be taken to your dealer for service as soon as possible.

This message can be displayed when the high voltage battery charge level is low. This is normal behavior as the vehicle is limiting power due to reduced battery capability.

Under certain operating conditions propulsion will be disabled. Try restarting after the vehicle has been off for two minutes.

PROPULSION POWER REDUCED DUE TO TEMPERATURE

This message displays when the vehicle is on, the battery temperature is low, and when the vehicle's performance is limited. The duration of the limited vehicle performance depends, in part, on the high voltage battery charge level. If the high voltage battery charge level is relatively

high, as the vehicle is driven, the battery temperature will increase, and the vehicle will return to normal operation. If the high voltage battery charge level is relatively low the vehicle will not return to normal operation until charged.

Keep the vehicle plugged in, even when fully charged, to keep the high voltage battery temperature ready for the next drive. This is important when outside temperatures are extremely hot or cold.

Vehicle Speed Messages

SPEED LIMITED TO XXX KM/H (MPH)

This message shows that the vehicle speed has been limited to the speed displayed. The limited speed is a protection for various propulsion and vehicle systems, such as lubrication, thermal, brakes, suspension, Teen Driver if equipped, or tires.

Lighting

Exterior Lighting

Exterior Lamp Controls	76
Headlamp High/Low-Beam Changer	77
Flash-to-Pass	77
Daytime Running Lamps (DRL)	77
Automatic Headlamp System	78
Hazard Warning Flashers	79
Turn and Lane-Change Signals	79
Exterior Cargo Lamps	79

Interior Lighting

Instrument Panel Illumination Control	80
Cargo Lamps	80
Dome Lamps	80

Lighting Features

Entry Lighting	81
Exit Lighting	81
Battery Load Management	81
Battery Power Protection	82
Exterior Lighting Battery Saver	82



Exterior Lighting

Exterior Lamp Controls



The exterior lamp control is on the turn signal lever.

Turn the control to the following positions:

 : Turns off the exterior lamps and deactivates AUTO mode. The knob returns to the AUTO position after it is released. Turn to  again to reactivate the AUTO mode.

For vehicles first sold in Canada, the headlamps will automatically reactivate when the vehicle is shifted out of P (Park).

AUTO : Automatically turns the exterior lamps on and off, depending on outside lighting.

 : Turns on the parking lamps including all lamps, except the headlamps.

 : Turns on the headlamps together with the parking lamps and instrument panel lights.

IntelliBeam System

This system turns the vehicle's high-beam headlamps on and off according to surrounding traffic conditions.

The system turns the high-beam headlamps on when it is dark enough and there is no other traffic present.

This light  (A) comes on in the instrument cluster when the IntelliBeam system is enabled.

Turning On and Enabling IntelliBeam



To enable the IntelliBeam system, press the button on the end of the turn signal lever when the exterior lamp control is in the AUTO or  position.

Driving with IntelliBeam

The system only activates the high beams when driving over 40 km/h (25 mph).

The blue high-beam on light appears on the instrument cluster when the high beams are on.

There is a sensor near the top center of the windshield that automatically controls the system. Keep this area of the windshield clear of debris to allow for best system performance.

The high-beam headlamps remain on, under the automatic control, until one of the following situations occurs:

- The system detects an approaching vehicle's headlamps.
- The system detects a preceding vehicle's taillamps.
- The outside light is bright enough that high-beam headlamps are not required.
- The vehicle's speed drops below 20 km/h (12 mph).
- The IntelliBeam system is disabled by the button on the turn signal lever. If this happens, press the button on the end of the turn signal lever when the exterior lamp control is in the AUTO or 

position. The instrument cluster light will come on to indicate the IntelliBeam system is reactivated.

The high beams may not turn off automatically if the system cannot detect another vehicle's lamps because of any of the following:

- The other vehicle's lamps are missing, damaged, obstructed from view, or otherwise undetected.
- The other vehicle's lamps are covered with dirt, snow, and/or road spray.
- The other vehicle's lamps cannot be detected due to dense exhaust, smoke, fog, snow, road spray, mist, or other airborne obstructions.
- The vehicle's windshield is dirty, cracked, or obstructed by something that blocks the view of the light sensor.
- The vehicle is loaded such that the front end points upward, causing the light sensor to aim high and not detect headlamps and taillamps.
- The vehicle is being driven on winding or hilly roads.

The automatic high-beam headlamps may need to be disabled if any of the above conditions exist.

Headlamp High/Low-Beam Changer

Push the turn signal lever away from you and release, to turn the high beams on. To return to low beams, push the lever again or pull it toward you and release.



This indicator light turns on in the instrument cluster when the high-beam headlamps are on.

Flash-to-Pass

To flash the high beams, pull the turn signal lever toward you, and release.

Daytime Running Lamps (DRL)

DRL can make it easier for others to see the front of your vehicle during the day.

Fully functional DRL are required on all vehicles first sold in Canada.

The DRL come on when all of the following conditions are met:

- The vehicle is on.
- The exterior lamp control is in AUTO.
- The light sensor determines it is daytime.

The taillamps, instrument panel lights, and other lamps will not turn on when this feature is activated.

The DRL turn off when the headlamps are turned to  or the vehicle is off.

For vehicles first sold in Canada, the DRL can only be turned off when the vehicle is parked.

Automatic Headlamp System

When the exterior lamp control is set to AUTO and it is dark enough outside, the headlamps come on automatically.

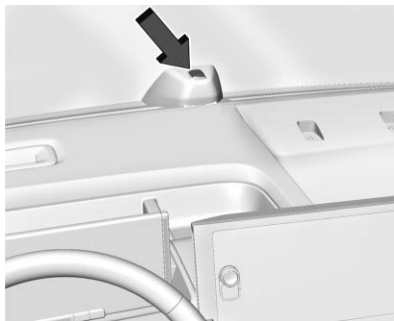

There is a light sensor on top of the instrument panel. Do not cover the sensor.



The system may also turn on the headlamps when driving through a parking garage or tunnel.

If the vehicle is started in a dark garage, the automatic headlamp system comes on immediately. If it is light outside when the vehicle leaves the garage, there is a slight delay before the automatic headlamp system changes to the Daytime Running Lamps (DRL). During that delay, the instrument cluster may not be as bright as usual. Make sure the instrument panel brightness control is in the full bright position. See *Instrument Panel Illumination Control* ⇨ 80.

When it is bright enough outside, the headlamps will turn off or may change to DRL.

The automatic headlamp system turns off when the exterior lamp control is turned to  or the vehicle is turned off.

Lights On with Wipers

If the windshield wipers are activated in daylight with the vehicle on, and the exterior lamp control is in AUTO, the headlamps, parking lamps, and other exterior lamps come on. The transition time for the lamps coming on varies based on wiper speed. When the wipers are not operating, these lamps turn off. Move the exterior lamp control to  or  to disable this feature.

Hazard Warning Flashers

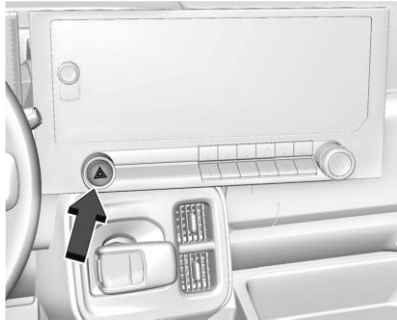

 : Press this button to make the front and rear turn signal lamps flash on and off. This warns others that you are having trouble. Press again to turn the flashers off.

The turn signals do not work while the hazard warning flashers are on.

The hazard warning flashers turn on automatically if the airbags deploy.

Turn and Lane-Change Signals

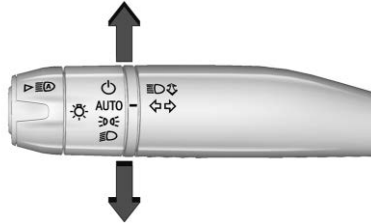

Move the lever all the way up or down to signal a turn.

An arrow on the instrument cluster will flash in the direction of the turn or lane change.

Raise or lower the lever until the arrow starts to flash to signal a lane change. Hold it there until the lane change is complete. If the lever is moved momentarily to the lane change position, the arrow will flash three times. It will flash six times if Tow/Haul Mode is active.

The lever returns to its starting position when it is released.

If after signaling a turn or lane change, the arrow flashes rapidly or does not come on, a signal LED may be burned out.

If a LED is not burned out, check the fuse. See *Instrument Panel Fuse Block* ⇨ 187.

See your dealer for service.

Exterior Cargo Lamps

The exterior cargo lamps provide more light in the rear of the vehicle, if needed.

Press the following button to turn the exterior cargo lamps on or off:

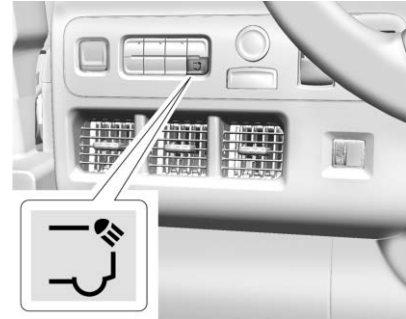

Activating the exterior cargo lamps may activate the cargo switch indicator, if equipped.

Become familiar with and follow all state and local laws that apply to cargo lamp operation.

Interior Lighting

Instrument Panel Illumination Control

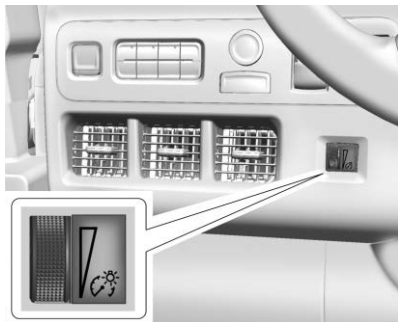

This feature adjusts the brightness of all illuminated controls.

 : Move the thumbwheel up or down to brighten or dim the lights.

The thumbwheel is functional at night, or when the headlamps or parking lamps are on.

Cargo Lamps

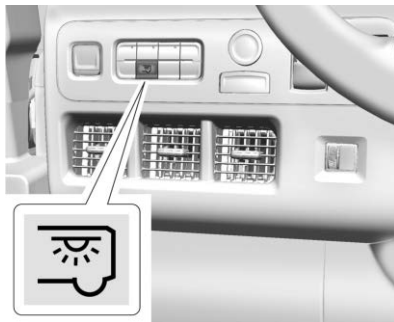

Press the button on the instrument panel to turn on the cargo lamps in the cargo area for approximately 30 seconds.

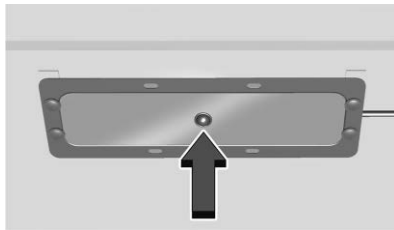

If equipped, the cargo lamps may have a motion sensor function that will turn on the lamps automatically with movement in the cargo area.

Dome Lamps



The dome lamps control is on the instrument panel.

To operate, press the following button:

 : Press to turn the dome lamps on or off manually.

Lighting Features

Entry Lighting

The interior lamps turn on when pressing  on the remote key or opening any doors, and the dome lamp control is in the door position.

Some exterior lamps also turn on when pressing  on the remote key or opening any doors. Low-Beam lamps will only turn on briefly at night, or in areas with limited lighting.

All lamps will gradually fade out after about 30 seconds.

Entry lighting can be disabled manually by closing all doors, pressing  on the remote key, or starting the vehicle.

This feature can be changed. On the infotainment home page, select Settings > Vehicle > Vehicle Locator Lights.

Exit Lighting

Some exterior lamps and interior lamps turn on when the driver door or the passenger door is opened after the vehicle is turned off.

The exterior and interior lamps remain on for a set amount of time, then automatically turn off. If equipped with Keyless Access, the exterior lamps automatically turn on when the driver door is opened after the vehicle is turned off.

The interior lights turn on when the vehicle is turned off.

The exterior lamps turn off immediately by turning the exterior lamp control off.

This feature can be changed. Touch the Setting icon and select Vehicle > Lighting > Exit Lighting.

Battery Load Management

The vehicle may have Electric Power Management (EPM) that estimates the battery's temperature and state of charge. It then adjusts the voltage for best performance and extended life of the battery.

When the battery's state of charge is low, the voltage is raised slightly to quickly bring the charge back up. When the state of charge is high, the voltage is lowered slightly to prevent overcharging. If the vehicle has a voltmeter gauge or a voltage display on the Driver Information Center

(DIC), you may see the voltage move up or down. This is normal. If there is a problem, an alert will be displayed.

The battery can be discharged at idle if the electrical loads are very high. This is true for all vehicles. This is because the generator (alternator) may not be spinning fast enough at idle to produce all the power that is needed for very high electrical loads.

A high electrical load occurs when several of the following are on, such as: headlamps, high beams, fog lamps, rear window defogger, climate control fan at high speed, heated seats, engine cooling fans, trailer loads, and loads plugged into accessory power outlets.

EPM works to prevent excessive discharge of the battery. It does this by balancing the generator's output and the vehicle's electrical needs. It can increase engine idle speed to generate more power, whenever needed. It can temporarily reduce the power demands of some accessories.

Normally, these actions occur in steps or levels, without being noticeable. In rare cases at the highest levels of corrective action, this action may be noticeable to the driver. If so, a Driver Information Center (DIC) message might be displayed, such as

SERVICE BATTERY CHARGING SYSTEM. If this messages displays, it is recommended that the driver reduce the electrical loads as much as possible.



Battery Power Protection

This feature helps prevent the battery from being drained if the interior courtesy lamps or reading lamps are accidentally left on.

If any of these lamps are left on, they automatically turn off after 10 minutes when the vehicle is turned off. The lamps will not come back on again until one of the following occurs:

- The vehicle is started.
- The doors are closed and then re-opened.

Exterior Lighting Battery Saver

The exterior lamps turn off about 10 minutes after the vehicle is turned off, if the parking lamps or headlamps have been manually left on. This protects against draining the battery. To restart the 10-minute timer, turn the exterior lamp control to the  position and then back to the  or  position.

To keep the lamps on for more than 10 minutes, the vehicle must be on.

Infotainment System

Introduction

Introduction	83
Overview	84
Steering Wheel Controls	85
Using the System	85
Software Updates	87

Radio

AM-FM Radio	87
Radio Reception	88
Multi-Band Antenna	89

Audio Players

Avoiding Untrusted Media Devices	89
USB Port	89
Bluetooth Audio	89

Navigation

Using the Navigation System	90
Maps	91
Navigation Symbols	91
Destination	91
Global Positioning System (GPS)	92
Vehicle Positioning	93
Problems with Route Guidance	93

Voice Recognition

Voice Recognition	93
-------------------------	----

Phone

Bluetooth (Overview)	95
Bluetooth (Pairing and Using a Phone)	96
Apple CarPlay and Android Auto	99

Settings

Settings	101
----------------	-----

Trademarks and License Agreements

Trademarks and License Agreements	102
--	-----

Introduction

Read the following pages to become familiar with the features.

Warning

Taking your eyes off the road for too long or too often while using any infotainment feature can cause a crash. You or others could be injured or killed. Do not give extended attention to infotainment tasks while driving. Limit your glances at the vehicle displays and focus your attention on driving. Use voice commands whenever possible.

The infotainment system has built-in features intended to help avoid distraction by disabling some features when driving. These features may gray out when they are unavailable. Many infotainment features are also available through the instrument cluster and steering wheel controls.

Before driving:

- Become familiar with the operation, center stack controls, steering wheel controls, and infotainment display.

- Set up the audio by presetting favorite stations, setting the tone, and adjusting the speakers.
- Set up phone numbers in advance so they can be called easily by pressing a single control or by using a single voice command.

See *Distacted Driving* ⇨ 111.

Overview

Infotainment System

The infotainment system is controlled by using the infotainment display, controls on the center stack, steering wheel controls, and voice recognition, if available.



1.  (Power)
 - Press to turn the power on.
 - Press to mute/unmute the system when on.

- Press and hold to display the power off screen or the option to display the power off screen.
 - Turn to decrease or increase the volume.
2. 
 - Press to go to the Home Page. See “Home Page” later in this section.
 - Press to exit Android Auto or Apple CarPlay. To enter back into Android Auto or Apple CarPlay, press and hold. See *Apple CarPlay and Android Auto* ⇨ 99.

Home Page

The Home Page is where vehicle application icons are accessed. Some applications are disabled when the vehicle is moving.

Swipe left or right across the display to access the pages of icons.

Card view is located on the right side of the screen. Scroll up and down through the different cards. Individual cards can not be added or deleted. For most of the apps in the cards, an open card view app will temporarily not be shown in card view.

Managing Home Page Icons

1. Touch and hold any of the Home Page icons to enter edit mode.
2. Continue holding the icon and drag it to the desired position.
3. Release your finger to drop the icon in the desired position.

Move an Icon to Another Page

1. Drag the icon to the edge of the display toward the desired page.
2. Continue dragging and dropping application icons as desired.

Move an Icon to the Application Tray

To move an icon to the application tray on the left side of the screen, drag the icon to the applications tray.

Steering Wheel Controls

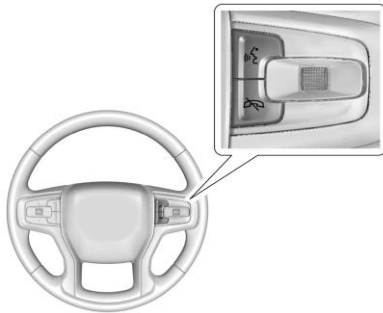

If equipped, some audio controls can be adjusted at the steering wheel.

 : Press to answer an incoming call or start voice recognition. See *Bluetooth (Pairing and Using a Phone)* ⇨ 96 or *Bluetooth (Overview)* ⇨ 95.

 : Press to decline an incoming call or end a current call. Press to mute or unmute the infotainment system when not on a call.

Using the System

Depending on the vehicle options, the following Apps may be available:

Phone

Touch the Phone icon to display the Phone main page. See *Bluetooth (Pairing and Using a Phone)* ⇨ 96 or *Bluetooth (Overview)* ⇨ 95.

Audio

Touch the Audio icon to display the audio screen. See *AM-FM Radio* ⇨ 87 and *Bluetooth Audio* ⇨ 89.

Wi-Fi Hotspot

Touch the Wi-Fi Hotspot icon to display the Wi-Fi Hotspot screen. See “Wi-Fi Hotspot” in *Settings* ⇨ 101.

Maps

Touch the Maps icon to display the Google Maps screen. See *Using the Navigation System* ⇨ 90.

Google Assistant

Touch the Google Assistant icon to open the Google Assistant app. See *Voice Recognition* ⇨ 93.

Google Play

Touch to download some of your favorite apps in your vehicle. Downloading apps on Google Play require you to sign into a Google Account with an active service plan with data. Some third-party apps require a separate account and, in some cases, a paid subscription for in-vehicle access.

Energy

Touch the Energy icon to open the Energy app. See *Energy Information* ⇨ 72.

Settings

Touch the Settings icon to display the Settings menu. See *Settings* ⇨ 101.

Apple CarPlay

Touch the Apple CarPlay icon to activate Apple CarPlay (if equipped) after a supported device is connected. See *Apple CarPlay and Android Auto* ⇨ 99.

Android Auto

Touch the Android Auto icon to activate Android Auto (if equipped) after a supported device is connected. See *Apple CarPlay and Android Auto* ⇨ 99.

Google applications such as Play Store, Assistant, and Maps are not available due to no data plan.

Shortcut Menu

The shortcut menu is along the left edge of the display. It shows up to five applications. To change the applications shown on the shortcut menu, touch and hold an icon and then drag it from the home page to the shortcut menu.

Infotainment Display Features

Infotainment display features show on the display when available. When a feature is unavailable, it may gray out. When a feature is touched, it may highlight.

Haptic Feedback

If equipped, haptic feedback is a pulse that occurs when an icon or option is touched on the display or when controls on the center stack are pressed.

Infotainment Gestures

Use the following finger gestures to control the infotainment system.

Touch/Tap

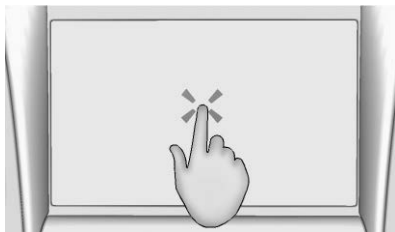

Touch/tap is used to select an icon or option, or activate an application.

Touch and Hold

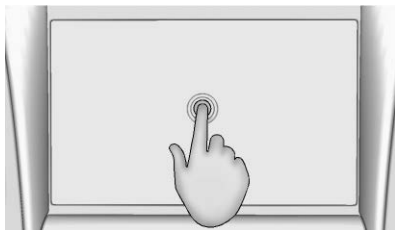

Touch and hold can be used to start another gesture, or to move or delete an application.

Drag

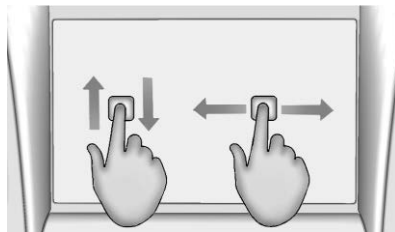

Drag is used to move applications on the Home Page. To drag the item, it must be held and moved along the display to the new location. This can be done up, down, right, or left. This feature is only available when vehicle is parked and not in motion.

Nudge

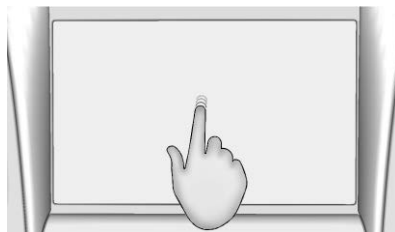

Nudge is used to move items a short distance on a list. To nudge, hold and move the selected item up or down to a new location.

Fling or Swipe

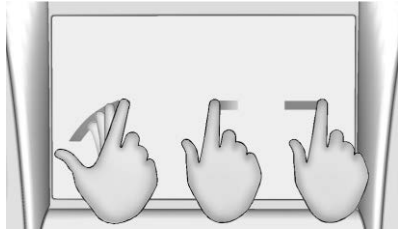

Fling or swipe is used to scroll through a list or change page views. Do this by placing a finger on the display then moving it rapidly up and down or right and left.

Spread

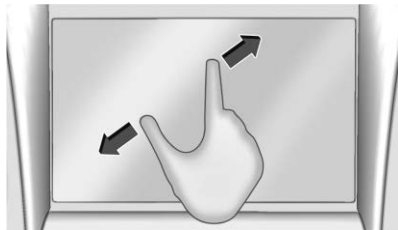

Spread is used to zoom in on certain images or a web page. Place finger and thumb together on the display, then move them apart.

Pinch

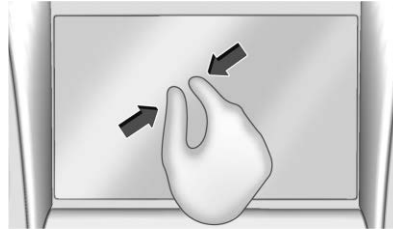

Pinch is used to zoom out on certain images or a web page. Place finger and thumb apart on the display, then move them together.

Cleaning High Gloss Surfaces and Vehicle Information and Radio Displays

For vehicles with high gloss surfaces or vehicle displays, use a microfiber cloth to wipe surfaces. Before wiping the surface with the microfiber cloth, remove dirt that could scratch the surface. Then use the microfiber cloth by gently rubbing to clean. Never use window cleaners or solvents. Periodically hand wash the microfiber cloth

separately, using mild soap. Do not use bleach or fabric softener. Rinse thoroughly and air dry before next use.

Software Updates

Over-the-Air Software Updates

If equipped, see “Updates” under *Settings*
 ⇨ 101 for details on software updates.

Radio

AM-FM Radio

Playing the Radio

From the Home Page, touch the Audio icon to display the now playing screen for the active audio source. Touch the source button such as FM or AM in the left corner to change your source.

Finding a Station

Seeking a Station

From the AM or FM screen, touch the back or forward buttons to search for the previous or next strong station.

Tune

Touch  on the infotainment display to enter the Tune screen. Enter a frequency using the keypad.

Touch the  to save the station as a favorite.

Entering a valid AM or FM frequency will automatically tune to the new station but not close the Tune screen.

Touch the Go button or frequency in the list to begin playing the station. The tune page will close and return to the now playing screen.

Storing Radio Station Favorites

Saved favorite stations will show at the bottom of the now playing screen.

AM or FM favorites can be stored by pressing and holding a favorite slot.

Audio Settings

Audio settings vary by region.

From the now playing screen, touch  and the following may display.

Sound

- Equalizer
- Fade/Balance
- Sound Mode (if equipped)

Bose AudioPilot

If equipped, adjusts the volume based on the noise inside the vehicle and vehicle speed.

Manage Radio Favorites

Displays a list of audio favorites that can be moved or deleted.

Radio Text (RDS)

When on, radio station call letters and messages from radio stations will be shown.

Radio Text Category

When on, category information about current radio content will be shown.

Radio Data System (RDS)

RDS relies on receiving specific RDS information from radio stations and only works when the information is available. It is possible that a radio station could broadcast information that causes the radio to work improperly.

In addition, RDS features are region and country of sale specific. This means specific RDS content may not be available in your listening area or in the country you operate the vehicle.

To turn RDS features on or off, see "Audio Settings" previously.

The following RDS features may be supported by radio broadcasters in your listening area:

RDS features

- Display radio station call letters
- Display messages from radio stations
- Provide radio station category information (when available)

Radio Reception

Unplug electronic devices from the accessory power outlets if there is interference or static in the radio.

FM

FM signals only reach about 16 to 65 km (10 to 40 mi). Although the radio has a built-in electronic circuit that automatically works to reduce interference, some static can occur, especially around tall buildings or hills, causing the sound to fade in and out.

AM

The range for most AM stations is greater than for FM, especially at night. The longer range can cause station frequencies to interfere with each other. Static can also occur when things like storms and power lines interfere with radio reception. When this happens, try reducing the treble on the radio.

SiriusXM Satellite Radio Service

If equipped, SiriusXM Satellite Radio Service provides digital radio reception. Tall buildings or hills can interfere with satellite radio signals, causing the sound to fade in and out. In addition, traveling or standing under heavy foliage, bridges, garages, or tunnels may cause loss of the SiriusXM signal for a period of time. Some cellular services may interfere with SXM reception causing loss of signal.

Mobile Device Usage

Mobile device usage, such as making or receiving calls, charging, or just having the mobile device on may cause static interference in the radio. Unplug the mobile device or turn it off if this happens.

Multi-Band Antenna

The multi-band roof antenna may be used for radio, navigation, and other communication systems, depending on the equipped options. To ensure clear reception, keep the antenna clear of obstructions, such as snow and ice. If the vehicle has a sunroof, and it is open, or a roof loaded with cargo, reception may be affected.

Audio Players

Avoiding Untrusted Media Devices

When using media devices such as USB and mobile devices, consider the source. Untrusted media devices could contain files that affect system operation or performance and should be avoided.

USB Port

The vehicle may be equipped with multiple USB ports. Ports may also be used for charging. Music may be played from a connected USB device.

Caution

To avoid vehicle damage, unplug all accessories and disconnect all accessory cables from the vehicle when not in use. Accessory cables left plugged into the vehicle, unconnected to a device, could be damaged or cause an electrical short if the unconnected end comes in contact with liquids or another power source such as the accessory power outlet.

USB Audio

To play music via USB:

1. On the audio now playing page, touch source and select USB.
2. If there is no device connected, follow the screen prompts to connect the device.
3. Supported media content will appear on the display.

Bluetooth Audio

Music may be played from a connected Bluetooth device.

Volume and song selection may be controlled by using the infotainment controls. If Bluetooth is selected and no volume is present, check the volume setting on the infotainment system.

To play music via Bluetooth:

1. On the audio now playing page, touch source and select the desired Bluetooth device.
2. If there is no device connected, follow the screen prompts to pair the device.
3. Supported media content will appear on the display.

Manage Bluetooth Devices

Managing Bluetooth devices allows you to add, delete, or select another paired device.

Only one Bluetooth device can be active at a time.

Some smartphones support sending Bluetooth music information to display on the radio. When the radio receives this information, it will check to see if any is available and display it. For more information about supported Bluetooth features, visit your brand website.

See *Radio Frequency Statement* ⇨ 237.

Navigation

Using the Navigation System

The Navigation software is provided by Google Maps. The information provided in this section is a general overview and is subject to change. For the latest functional information, see g.co/mapsincarc.

Accept the Terms and Conditions to use.

Internet Connectivity

Google Maps relies on a subscription data plan for full functionality, including availability of offline maps. With an applicable connected services plan, Google Maps can be used offline when driving through connectivity dead zones by auto-downloading offline maps prior to going offline.

Profiles

Sign in to a Google Account for personalized service. Information available in the Google Account will be shown.

To log into a profile, see *Accounts* under *Settings* ⇨ 101.

Voice Assistant

If equipped, Google Maps can be controlled by voice commands, see *Google Assistant* under *Voice Recognition* ⇨ 93.

Language and Units

To change the language, see *Settings* ⇨ 101.

To change the units, see *Instrument Cluster* ⇨ 55.

Mute Settings

During active route guidance, Google Maps can give audible voice directions, traffic alerts, or can be muted. In the Google Maps app, touch *Settings*, then *Mute* settings to access the options. Alternatively, audible voice directions and traffic alerts can be muted by tapping the sound icon on the turn card during active navigation.

Compass

The Google Maps orientation can be changed between the current direction of travel, north, and route overview. Touch the compass to switch between these options.

To recenter the map to the current location, touch the location icon.

Electric Vehicle (EV) Features with Google Maps

When vehicle data is shared with Google, some of the Maps features for EVs are as follows:

- Estimated battery charge level at arrival
- Estimated minimum charging time in order to reach destination

If the vehicle needs to be charged to reach a destination, charging stations may automatically be added to a route.

Maps

Auto-downloaded Maps

Google Maps downloads maps automatically for use when not connected to the Internet. Offline maps make map data available to vehicle features regardless of connectivity. These offline maps are only available with an applicable connected services plan.

To turn on auto-download:

1. Open Google Maps.
2. Touch the settings icon.
3. Touch Privacy center, then select Offline maps.
4. Select Auto-download offline maps.

5. Check the Internet connection and wait for the download to finish.

Downloading Offline Maps

1. Open Google Maps.
2. Touch Settings, then Offline maps.
3. Touch the square with the Select your own map icon.
4. Adjust the map to cover the desired area to download.
5. Touch Download.

Navigation Symbols

The following are the most common symbols that may appear in Google Maps.



This indicates the vehicle's current location and direction on the map.



The destination pin marks the location of the final destination. Touch the pin to view the destination address or to add it or remove it from the Favorites list. Hide the information by touching the pin one more time. It will automatically time out if no action is taken.

A second pin in the menu is the route overview. Touch this pin to show more details of the destination or to remove the destination.

Destination

Searching for a Destination

A destination can be searched using Google Assistant.

To search for a destination without Google Assistant:

1. Open Google Maps.
2. Touch the Search field.
3. Enter the destination.

4. Touch the navigation icon.

Alternate Routes

Alternate routes are displayed as separate lines. While in either turn-by-turn navigation or on the route overview, touch the suggested alternate route.

Adding a Stop on Route by Voice

1. While in turn-by-turn navigation, touch the Search icon at the bottom.
2. Touch the Google Assistant mic icon and say the destination to search by voice.
3. Select the desired search result from the list.
4. Touch the Add stop icon.

Adding a Stop on Route by Category

1. While in turn-by-turn navigation, touch the Search icon at the bottom.
2. Select a category.
3. Select the desired search result from the list.
4. Touch the Add stop icon.

Adding a Home or Work Address

To edit a home or work address, an account must be logged in. See *Accounts* under *Settings* ⇨ 101.

1. Open Google Maps.
2. Touch Settings and then touch Edit home or work.
3. Enter the address.

Search by Category

Destinations can be searched by category, such as restaurant or grocery store.

1. Open Google Maps.
2. Touch the search bar.
3. Touch Categories, then select a category.
4. Touch the desired location, then touch the navigation icon.

Avoid Tolls, Highways, or Ferries

1. Open Google Maps.
2. Touch the settings icon.
3. Select Route options.
4. Select the desired options and then touch X to close.

An Alternative Way for General Route Options

1. During active route guidance, touch Route Overview.
2. Select Route options.
3. Select the desired option and then touch X to close.

Traffic Layers

1. Open Google Maps.
2. Touch the settings icon.
3. Toggle between Traffic on or off.

Global Positioning System (GPS)

The current position of the vehicle is determined by using satellite signals and various vehicle signals.

At times, other interference such as the satellite condition, road configuration, condition of the vehicle, and/or other circumstances can affect the navigation system's ability to determine the accurate position of the vehicle.

This system might not be available or interference can occur if any of the following are true:

- Signals are obstructed by tall buildings, trees, large trucks, or a tunnel.
- Satellites are being repaired or improved.

For more information if the GPS is not functioning properly, see *Problems with Route Guidance* ⇨ 93.

Vehicle Positioning

At times, the position of the vehicle on the map could be inaccurate due to one or more of the following reasons:

- The road system has changed.
- The vehicle is driving on slippery road surfaces such as sand, gravel, or snow.
- The vehicle is traveling on winding roads or long, straight roads.
- The vehicle is approaching a tall building or a large vehicle.
- The surface streets run parallel to a freeway.
- The vehicle has been transferred by a vehicle carrier or a ferry.
- The current position calibration is set incorrectly.
- The vehicle is traveling at high speed.
- The vehicle changes directions more than once, or the vehicle is turning on a turn table in a parking lot.
- The vehicle is entering and/or exiting a parking lot, garage, or a lot with a roof.
- The GPS signal is not received.
- A roof carrier is installed on the vehicle.
- Tire chains are installed on the vehicle.
- The tires are replaced or worn.

- The tire pressure for the tires is incorrect.
- This is the first navigation use after the map data is updated.
- The 12-volt battery has been disconnected for several days.
- The vehicle is driving in heavy traffic where driving is at low speeds, and the vehicle is stopped and started repeatedly.

Problems with Route Guidance

Inappropriate route guidance can occur under one or more of the following conditions:

- The turn was not made on the road indicated.
- Route guidance might not be available when using automatic rerouting for the next right or left turn.
- The route might not be changed when using automatic rerouting.
- There is no route guidance when turning at an intersection.
- Automatic rerouting might display a route returning to the set waypoint if heading for a destination without passing through a set waypoint.

- The route prohibits the entry of a vehicle due to a regulation by time or season or any other regulation which may be given.
- Some routes might not be searched.
- The route to the destination might not be shown if there are new roads, if roads have recently changed, or if certain roads are not listed in Maps.

To recalibrate the vehicle's position on the map, park with the vehicle running for two to five minutes, until the vehicle position updates. Make sure the vehicle is parked in a location that is safe and has a clear view of the sky and away from large obstructions.

Voice Recognition



If equipped, Google Assistant allows for hands-free use of media and messaging, navigation, and climate control functionality in the vehicle. This feature can be started by pressing  on the steering wheel, touching Google Assistant on the infotainment home screen, or by using the wake up words "Hey Google" or "OK Google."

However, not all features within these areas are supported by voice commands and requires the user to have a valid data

subscription plan or be able to connect to an external WiFi in order to use the Google Assistant features.

Using Voice Recognition

Voice recognition becomes available once the system is initialized. This begins when the vehicle is turned on. Initialization may take a few moments.

1. Press  on the steering wheel controls, touch Google Assistant on the Home screen, or use the wake up words “Hey Google” or “OK Google” to activate voice recognition. Google Assistant must be set as the Default Assistant for the  and the wake word options to work.
2. Clearly speak one of the commands described later in this section.

Canceling Google Assistant

- Press  on the steering wheel controls to cancel the Google Assistant request.

Helpful Hints for Speaking Commands

Voice recognition identifies commands that are naturally stated in sentence form, or direct commands that state the application and the task.

For best results:

- Speak the command naturally, not too fast, not too slow.
- Use direct commands without a lot of extra words. For example, “Call <name> at work,” “Play” followed by the artist or song name, or “Play” followed by the radio station number.

Direct commands are more clearly understood by the system. An example of a direct command is “Call <number>.”

If a cell phone number was saved with a name and a place, the direct command should include both. For example “Call <name> at work.”

Voice Recognition for the Radio

When voice is started, the voice recognition commands for AM, FM, SiriusXM (if equipped), and media apps (if supported) are available.

“Play <AM frequency> AM” : Tune to the radio station frequency identified in the command (like “nine fifty”).

“Play <FM frequency> FM” : Tune to the radio station frequency identified in the command (like “one oh one point one”).

“Play channel <SXM channel number> on SiriusXM” : Tune to the SiriusXM radio station channel number identified in the command. This command may require an online connection.

“Play <SXM channel name> on Sirius XM” : Tune to the SiriusXM radio station channel name identified in the command. This command may require an online connection.

“Play <Media> on <Audio Source>” : Play media like a song or channel using a specified audio source such as Pandora or Spotify. This command may require an online connection.

Voice Recognition for the Phone

Make sure the phone is paired using Bluetooth to use the phone related voice commands.

“Call <contact name>” : Initiate a call to a stored contact. The command may include location if the contact has location numbers stored. You must accept Personal Results permission during set up for access to the contacts.

“Call < phone number>” : Initiate a call to a phone number of seven digits or 10 digits.

“Send a message to <contact name>” : Send a message to a stored contact.

Voice Recognition for Navigation

Navigation commands can be used to start, cancel route, or add way points/POI.

“Navigate to <destination address>” : Initiate navigation to the address in the command.

“Find a <Place of Interest>” : Find and initiate navigation to a POI in the command.

“Add <destination> on my way” : Adds a way-point to the current route.

“Take me home” : Starts navigation to Home location set in Google maps.

Onboard Vehicle Commands

These commands can be used to adjust vehicle temperature, control window defrosters, etc.

“Turn on the A/C” : Turns on the air conditioning.

“Set temperature to <desired number> degrees” : Set to a specific temperature inside your vehicle.

Phone Assistant Voice Recognition

While a device is connected via Bluetooth, Android Auto, or CarPlay, press and hold  on the steering wheel controls to pass through and launch the Voice Assistant on the connected mobile phone (e.g, Google assistant, Siri, etc.).

Phone

Bluetooth (Overview)

The Bluetooth-capable system can interact with many mobile devices to:

- Place and receive calls in a hands-free mode.
- Share the device’s address book or contact list with the vehicle.
- Stream audio (music, podcasts).
- Notify receipt of text messages.

To minimize driver distraction, before driving, and with the vehicle parked:

- Become familiar with the features of the mobile device. Organize the phone book and contact lists clearly and delete duplicate or rarely used entries.
- Review the controls and operation of the infotainment system.

- Pair mobile device(s) to the vehicle. The system may not work with all mobile devices. See “Pairing” later in this section.

Vehicles with a Bluetooth system can use a Bluetooth-capable mobile device with a Hands-Free Profile to make and receive phone calls. The infotainment system and voice recognition are used to control the system. The system can be used while the vehicle is on. The range of the Bluetooth system can be up to 9.1 m (30 ft). Not all mobile devices support all functions and not all mobile devices work with the Bluetooth system.

Controls

Use the controls on the infotainment display and the steering wheel to operate the Bluetooth system.

Steering Wheel Controls

 : Press and release to answer incoming calls on your connected Bluetooth mobile device. Press and hold for mobile device assistant.

 : Press to end a call, decline a call, or cancel an operation. Press to mute or unmute the infotainment system when not on a call.

Infotainment System Controls

For information about how to navigate the menu system using the infotainment controls, see *Using the System* ⇨ 85.

Audio System

When using the Bluetooth mobile device system, sound comes through the vehicle's front audio system speakers and overrides the audio system. The volume level while on a mobile device call can be adjusted by pressing the steering wheel controls or the volume control on the center stack. The adjusted volume level remains in memory for later calls. The volume cannot be lowered beyond a certain level.

Bluetooth (Pairing and Using a Phone)

Pairing

A Bluetooth-enabled mobile device must be paired to the Bluetooth system and then connected to the vehicle before it can be used. See the mobile device manufacturer's user guide for Bluetooth functions before pairing the device.

Pairing Information

- Touch the Phone icon on the home page of the infotainment display.
- If no mobile device has been paired, a message on the infotainment display will show the Manage Phones option. Touch this option and the Phones screen will display. See "Pairing a Phone" later in this section.
- A Bluetooth smartphone with music capability can be paired to the vehicle as a smartphone and a music player at the same time.
- Up to 10 devices can be paired to the Bluetooth system.
- The pairing process is disabled when the vehicle is moving.
- Pairing only needs to be completed once, unless the pairing information on the cell phone changes or the cell phone is deleted from the system.
- If multiple paired cell phones are within range of the system, the system connects to the paired cell phone that is set to First to Connect. If there is no cell phone set to First to Connect, it will link to the cell phone which was used last. To link to a different paired cell phone, see "Linking to a Different Phone" later in this section.

Pairing a Phone

1. Make sure Bluetooth has been enabled on the cell phone before starting the pairing process.
2. Touch the Phone icon on the Home Page.
3. If no mobile device is connected, touch Manage Phones and the Phones screen will display.
If another mobile device is connected already, touch Settings, Connections, and then Phones.
4. Touch Add Phone.
If a previously added phone is disconnected, the "Add Phone" card will just be a "+" card.
5. Follow the on-screen prompts to pair the cell phone.
6. Follow the instructions on the cell phone to confirm the six-digit code showing on the infotainment display and touch Pair. The code on the cell phone and infotainment display needs to be acknowledged for a successful pair.
7. Start the pairing process on the cell phone to be paired to the vehicle. See the cell phone manufacturer's user guide

for information on this process. Once the cell phone is paired, it will show as Connected.

8. If the vehicle name does not appear on your cell phone, there are a few ways to start the pairing process over:
 - Make sure there is not an entry for the vehicle under the previously connected list. If the vehicle and cell phone were previously paired and one still remembers the other, it will not identify as a new device when searching.
 - Turn the Bluetooth off and on the device.
 - Go back to the beginning of the Phone menus on the infotainment display and restart the pairing process.
 - Turn the cell phone off and then back on.
 - Reset the cell phone, but this step should be done as a last effort.
9. If the cell phone prompts to accept connection or allow phone book download, touch Always Accept and Allow. The phone book may not be available if not accepted.

10. To pair additional cell phones, touch Settings, Connections, and then Phones.

First to Connect Paired Phones

If multiple paired cell phones are within range of the system, the system connects to the paired cell phone that is set as First to Connect. To enable a paired cell phone as the First to Connect phone:

1. Make sure the cell phone is turned on.
2. Touch the Settings icon on the home page.
3. Touch Connections.
4. Touch Phone.
5. Touch Options under the connected phone.
6. Touch First to Connect from the cell phone's settings menu. The settings will be enabled for that device.

Cell phones and mobile devices can be added, removed, connected, and disconnected. A sub-menu will display whenever a request is made to add or manage cell phones and mobile devices.

Accessing the Device List Screen

There are two ways to access the device list screen:

Using the Settings Icon

1. Touch the Settings icon on the Home Page or the Settings icon on the shortcut tray near the left of the display.
2. Touch Connections.
3. Touch Phones.

Using the Phone Icon

1. Touch the Phone icon on the Home Page or the Phone icon on the shortcut tray near the left of the display.
2. Touch  on the top right of the Phones screen.
3. Touch Connected Phone.

Disconnecting a Connected Phone

To disconnect a phone:

1. Open the Device List Screen. See "Accessing the Device List Screen" previously in this section.
2. Touch Option on the phone card to show the cell phone's or mobile device's settings.
3. Touch Disconnect.

Deleting a Paired Phone

To delete a paired phone:

1. Open the Device List Screen. See “Accessing the Device List Screen” previously in this section.
2. Touch Option on the phone card to show the cell phone’s or mobile device’s settings.
3. Touch Forget Phone.

Linking to a Different Phone

To link to a different cell phone, the new cell phone must be in the vehicle and paired to the Bluetooth system.

To link to a different phone:

1. Open the Device List Screen. See “Accessing the Device List Screen” previously in this section.
2. Touch the new cell phone to link to from the list of available phones. See “First to Connect Paired Phones” previously in this section.

Switching to Handset or Hands-Free Mode

To switch between handset or hands-free mode:

- While the active call is hands-free, touch the Audio Output option, then touch Phone to switch to the handset mode. The mute icon will not be available or functional while Handset mode is active.
- While the active call is on the handset, touch the Audio Output option, then touch Car Speakers to switch to the hands-free mode.

Making a Call Using Contacts

Calls can be made through the Bluetooth system using personal cell phone contact information for all cell phones that support the Phone Book feature. Become familiar with the cell phone settings and operation and that the phone is set to allow the sharing of contacts over Bluetooth with the vehicle. Verify the cell phone supports this feature and that the phone is set to allow the sharing of contacts over Bluetooth with the vehicle.

The Contacts menu accesses the phone book stored in the cell phone.

To make a call using the Contacts menu:

1. Touch the Phone icon on the Home Page or on the shortcut tray near the left of the display.
2. Touch Contacts.
3. There are two methods to search for contacts:
 - Search bar – Touch the search icon on the top right of the Phones window and type the name or number of the contact on the keyboard. Search results will be displayed corresponding to the user input. Touch the name to call.
 - Scroll – Touch the list and scroll, or use the scrollbar on the left side of the Phones window. Touch the name to call.

Making a Call Using the Recents Menu

The Recents menu accesses the recents call list from your cell phone.

To make a call using the Recents menu:

1. Touch the Phone icon on the Home Page or on the shortcut tray near the left of the display.
2. Touch Recents.
3. Touch the name or number to call.

Making a Call Using the Keypad

To make a call by dialing the numbers:

1. Touch the Phone icon on the Home Page or on the shortcut tray near the left of the display.
2. Touch Keypad and enter a phone number.
3. Touch the phone icon on the infotainment display to start dialing the number.

Searching Contacts Using the Keypad

To search for contacts using the keypad:

1. Touch the Phone icon on the Home Page.
2. Touch Keypad and enter partial phone numbers or contact names using the digits on the keypad to search.

Results appear on the right side of the display. Touch one to place a call.

Accepting or Declining a Call

When an incoming call is received, the infotainment system mutes and a ring tone is heard in the vehicle.

Accepting a Call

There are two ways to accept a call:

- Press  on the steering wheel controls.

- Touch Answer on the infotainment display.

Declining a Call

There are two ways to decline a call:

- Press  on the steering wheel controls.
- Touch Decline on the infotainment display.

Call Waiting

Call waiting must be supported on the Bluetooth cell phone and enabled by the wireless service carrier to work.

Accepting a Call

Press  to answer, then touch Switch on the infotainment display.



Declining a Call

Press  to decline, then touch Decline on the infotainment display.

Switching Between Calls (Call Waiting Calls Only)

To switch between calls, touch Phone on the Home Page to display Call View. While in Call View, touch the call information of the call on hold to change calls.

Ending a Call

- Press  on the steering wheel controls.
- Touch  on the infotainment display, next to a call, to end only that call.

Dual Tone Multi-Frequency (DTMF) Tones

The in-vehicle Bluetooth system can send numbers during a call. This is used when calling a menu-driven phone system. Use the Keypad to enter the number.

Apple CarPlay and Android Auto

If equipped, Android Auto and/or Apple CarPlay capability may be available through a compatible smartphone. If available, the Android Auto and Apple CarPlay icons will change from gray to color on the Home Page of the infotainment display.

To use Android Auto and/or Apple CarPlay:

For Wired Phone Projection

1. Connect your Android phone or Apple iPhone by using the factory-provided phone USB cable and plugging into a USB data port. For best performance, it is highly recommended to use the device's factory-provided USB cable, which should

be replaced after significant wear to maintain connection quality. Aftermarket or third-party cables may not work.

2. When the phone is first connected to activate Apple CarPlay or Android Auto, accept the terms and conditions on both the infotainment system and the phone.
3. Follow the instructions on the phone.

The Android Auto and Apple CarPlay icons on the Home Page will illuminate depending on the smartphone. Android Auto and/or Apple CarPlay may automatically launch the next time the USB is connected. If not, touch the Android Auto or Apple CarPlay icon on the Home Page to launch.

Press  on the center stack to return to the Home Page.

For Wireless Phone Projection

Verify your phone is wireless compatible by visiting the Google Android Auto or Apple CarPlay support page.

1. For first time connection, there are two ways to set up wireless projection:
 - Connect your Android phone or Apple iPhone by using the factory-provided phone USB cable and plugging into a USB data port. For best performance,

it is highly recommended to use the device's factory-provided USB cable, which should be replaced after significant wear to maintain connection quality. Aftermarket or third-party cables may not work.

- Connecting the phone over Bluetooth. See *Bluetooth (Pairing and Using a Phone)* ⇨ 96 or *Bluetooth (Overview)* ⇨ 95.
2. Make sure Wi-Fi and Bluetooth is turned on the phone for wireless projection to work.
 3. When the phone is first connected to activate Apple CarPlay or Android Auto, agree to the terms and conditions on both the infotainment system and the phone.
 4. Follow the instructions on the phone.

The Android Auto and Apple CarPlay icons on the Home Page will illuminate depending on the smartphone. Android Auto and/or Apple CarPlay may automatically launch upon wireless connection. If not, touch the Android Auto or Apple CarPlay icon on the Home Page to launch.

Wireless CarPlay and/or Wireless Android Auto may experience occasional service disruption due to outside Wi-Fi interference.

To disconnect the phones wireless projection:



1. Select the Settings icon from the Home Page or the Settings icon on the shortcut tray near the left of the display.
2. Select Connections.
3. Touch Phones.
4. Touch Option on the phone card to show the cell phone's or mobile device's settings.
5. Turn off Apple CarPlay or Android Auto.

Press  on the center stack to return to the Home Page.

Features are subject to change. For further information on how to set up Android Auto and Apple CarPlay in the vehicle, visit your brand website.

Android Auto is provided by Google and is subject to Google's terms and privacy policy. Apple CarPlay is provided by Apple and is subject to Apple's terms and privacy policy.

Data plan rates apply. For Android Auto support and to see if your phone is compatible, see <https://www.android.com/auto/compatibility>. For Apple CarPlay support and to see if your phone is compatible, see www.apple.com/ios/carplay/. Apple or Google may change or suspend availability at any time. Android Auto, Android, Google, Google Play, and other marks are trademarks of Google Inc.; Apple CarPlay is a trademark of Apple Inc.

Press  on the center stack to exit Android Auto or Apple CarPlay. To enter back into Android Auto or Apple CarPlay, press and hold  on the center stack.

Settings

To access the personalization menus:

1. Touch Settings on the Home Page on the infotainment display.
2. Touch the desired category to display a list of available options.
3. Touch to select the desired feature setting.

4. Touch the options on the infotainment display to disable or enable a feature.
5. Touch  to go back.

The Settings menu may contain the following:

Connections

The menu may contain the following:

Phones

Allows connecting to a different cell phone or mobile device source, disconnect a cell phone or media device, or delete a cell phone or media device.

Wi-Fi Networks

Shows connected and available Wi-Fi networks.

Wi-Fi Hotspot

Allows adjustment of different Wi-Fi features.

Vehicle-to-Phone Sharing

Trusted Device

Allows for setting a phone as your trusted device, if equipped.

Vehicle

The menu may contain the following:

One-Pedal Driving

When on, the vehicle will slow/stop when the accelerator is let off. See *One-Pedal Driving* ⇨ 127.

Climate and Air Quality

Adjusts different climate settings.

Collision/Detection Systems

Adjusts different driver assistance system settings.

Comfort and Convenience

Adjusts different comfort and convenience settings.

Lighting

Adjusts different lighting settings.

Power Door Locks

Adjusts different door lock settings.

Remote Lock, Unlock, and Start

Adjusts different remote lock settings.

Apps & Permissions

Shows a list of installed apps and the permissions used.

Date / Time

Allows setting of the clock.

Display

Allows adjustment of the infotainment display.

Sounds

Allows adjustment of the infotainment system sounds.

Profiles & Accounts

Modifies the infotainment systems profiles and provides access to the accounts assigned to the currently active profile.

Privacy

Touch and the following may display:

Location Services

Touch to view the Location Services screen.

App permissions

Touch to view the Permission manager screen.

GM Privacy Statement

Touch to view the GM Privacy Statement screen.

Storage

This menu shows the storage info on the infotainment system.

Security

This menu allows adjustment of the infotainment security settings.

System

The menu may contain the following:

Language

This will set the display language used on the infotainment display.

Quick Startup

This allows your infotainment system to quickly resume its last session.

Reset Options

Touch to change reset settings.

About

Touch to view the infotainment system software information.

Legal Information

Touch to view legal and license information.

Updates

This menu allows adjustment of the vehicle update settings.

Trademarks and License Agreements

FCC Information

See *Radio Frequency Statement* ⇨ 237.



"Made for iPhone," means that an electronic accessory has been designed to connect specifically to iPhone, and has been certified by the developer to meet Apple performance standards. Apple is not responsible for the operation of this device or its compliance with safety and regulatory standards. Please note that the use of this accessory with iPhone may affect wireless performance. iPhone are trademarks of Apple Inc., registered in the U.S. and other countries.



Trial length and service availability may vary by model, model year or trim. Service will automatically stop at the end of your trial subscription period unless you decide to continue service. If you do not wish to enjoy your trial, you can cancel by calling the number below. All SiriusXM services require a subscription, each sold separately by SiriusXM after the trial period. Service subject to the applicable SiriusXM Customer Agreement and Privacy Policy, visit www.siriusxm.com (USA) or www.siriusxm.ca (Canada) to see complete terms and how to cancel which includes calling 1-866-635-2349 (USA) or 1-888-539-7474 (Canada). Some services and features are subject to device capabilities and location availability. Content varies by SiriusXM subscription package. All fees, content and features are subject to change.

SiriusXM with 360L: Some features, including streaming content and listening recommendations, require an active OnStar

Connected Access plan and may vary by vehicle model. Content varies by SiriusXM subscription plan. GM connected vehicle services vary by vehicle model and require active service plan, working electrical system, cell reception and GPS signal. See onstar.com for details and limitations.

SiriusXM, Pandora, Stitcher and all related logos are trademarks of Sirius XM Radio Inc. and its respective subsidiaries.

SiriusXM satellite service is only available in the 48 contiguous United States (and Puerto Rico with limited availability) and Canada.

In Canada: Some deterioration of service may occur in extreme northern latitudes. This is beyond the control of SiriusXM.

Explicit Language Notice: Channels with frequent explicit language are indicated with an "XL" after the channel name. Family-friendly packages are available by contacting SiriusXM:

- USA Customers — See www.siriusxm.com or call 1-888-601-6296.
- Canada Customers — See www.siriusxm.ca or call 1-877-438-9677.

It is prohibited to copy, decompile, disassemble, reverse engineer, hack, manipulate, or otherwise make available any

technology or software incorporated in receivers compatible with the SiriusXM Satellite Radio System or that support the SiriusXM website, the Online Service or any of its content.

General Requirements:

1. A License Agreement from SiriusXM is required for any product that incorporates SiriusXM Technology and/or for use of any of the SiriusXM marks to be manufactured, distributed, or marketed in the SiriusXM Service Area.
2. For products to be distributed, marketed, and/or sold in Canada, a separate agreement is required with Sirius XM Canada Inc.



TouchSense Technology and TouchSense System 1000 Series Licensed from Immersion Corporation. TouchSense System 1000 is protected under one or more of the

U.S. Patents at the following address www.immersion.com/patent-marking.html and other patents pending.

Bose

Bose AudioPilot and Bose Centerpoint surround are registered trademarks of Bose Corporation in the U.S. and other countries.

Bluetooth

The Bluetooth word mark and logos are owned by the Bluetooth SIG, Inc. and any use of such marks by General Motors is under license. Other trademarks and trade names are those of their respective owners.

Java

Java is a registered trademark of Oracle and/or its affiliates.

MPEG4-AVC (H.264)

THIS PRODUCT IS LICENSED UNDER THE AVC PATENT PORTFOLIO LICENSE FOR THE PERSONAL AND NON-COMMERCIAL USE OF A CONSUMER TO (i) ENCODE VIDEO IN COMPLIANCE WITH THE AVC STANDARD (“AVC VIDEO”) AND/OR (ii) DECODE AVC VIDEO THAT WAS ENCODED BY A CONSUMER ENGAGED IN A PERSONAL AND NON-COMMERCIAL ACTIVITY AND/OR WAS OBTAINED FROM A VIDEO PROVIDER

LICENSED TO PROVIDE AVC VIDEO. NO LICENSE IS GRANTED OR SHALL BE IMPLIED FOR ANY OTHER USE. ADDITIONAL INFORMATION MAY BE OBTAINED FROM MPEG LA, LLC. SEE [HTTPS://WWW.MPEGLA.COM](https://www.mpegla.com).

VC-1

THIS PRODUCT IS LICENSED UNDER THE VC-1 PATENT PORTFOLIO LICENSE FOR THE PERSONAL AND NON-COMMERCIAL USE OF A CONSUMER TO (i) ENCODE VIDEO IN COMPLIANCE WITH THE VC-1 STANDARD (“VC-1 VIDEO”) AND/OR (ii) DECODE VC-1 VIDEO THAT WAS ENCODED BY A CONSUMER ENGAGED IN A PERSONAL AND NON-COMMERCIAL ACTIVITY AND/OR WAS OBTAINED FROM A VIDEO PROVIDER LICENSED TO PROVIDE VC-1 VIDEO. NO LICENSE IS GRANTED OR SHALL BE IMPLIED FOR ANY OTHER USE. ADDITIONAL INFORMATION MAY BE OBTAINED FROM MPEG LA, LLC. SEE [HTTPS://WWW.MPEGLA.COM](https://www.mpegla.com).

MPEG4-Visual

USE OF THIS PRODUCT IN ANY MANNER THAT COMPLIES WITH THE MPEG-4 VISUAL STANDARD IS PROHIBITED, EXCEPT FOR USE BY A CONSUMER ENGAGING IN PERSONAL AND NON-COMMERCIAL ACTIVITIES.

MP3

MPEG Layer-3 audio coding technology licensed from Fraunhofer IIS and Thomson.

WMV/WMA

This product includes technology owned by Microsoft Corporation and under a license from Microsoft Licensing, GP. Use or distribution of such technology outside of this product is prohibited without a license from Microsoft Corporation and/or Microsoft Licensing, GP as applicable.

Climate Controls

Climate Control Systems

Automatic Climate Control System 105

Air Vents

Air Vents 107

Maintenance

Passenger Compartment Air Filter 108

Service 108

Climate Control Systems

Automatic Climate Control System

With this system the heating, cooling, and ventilation in the vehicle can be controlled.

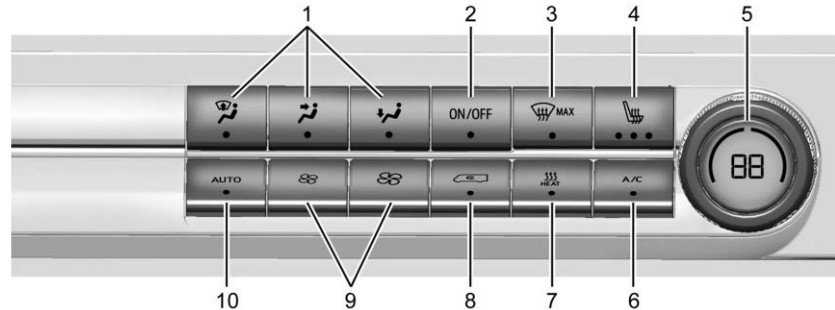

1. Air Delivery Mode Controls

2. ON/OFF

3. Defrost

4. Heated Seat

5. Temperature Control

6. A/C (Air Conditioning)

7. Heat

8. Air Recirculation

9. Fan Control

10. AUTO (Automatic Operation)

Automatic Operation

The system automatically heats or cools the vehicle to the desired temperature using the following functions:

- Fan Speed
- Air Delivery Mode
- Air Conditioning
- Recirculation

When AUTO is pressed, the A/C and heat settings are automatically chosen based on the set temperature and outside conditions. Selecting AUTO optimizes comfort and system efficiency. It is highly recommended to select AUTO as A/C or Heat mode may compromise cabin comfort. When enabled, the climate controls remain in AUTO mode through power cycles.

To place the system in full automatic operation:

1. Press AUTO.
2. Set the temperature.

To find your comfort setting, start with 22 °C (72 °F) and allow the system time to stabilize. Then adjust the temperature as needed for best comfort.

To improve energy efficiency and to cool the vehicle faster, recirculation may be automatically selected in warm weather.

The recirculation light will not come on when automatically controlled. Press  to manually select recirculation; press it again to select outside air.



Do not cover the solar sensor on the top of the instrument panel near the windshield. This sensor regulates air temperature based on sun load. See “Sensors” later in this section.

Manual Operation

ON/OFF : Press to turn the climate control system on or off. When the system is turned off, air will stop flowing into the cabin. Press **ON/OFF** again or adjust any of the climate controls to turn the system back on. The airflow will continue based on the selected climate control settings.

 : Press to increase or decrease the fan speed. Pressing this button cancels automatic fan control and allows you to control the fan speed manually. Press AUTO to return to automatic operation.

Temperature Control : Turn the knob clockwise or counterclockwise to increase or decrease temperature setting.

Air Delivery Mode Controls : Press , , or , to change the direction of the airflow. An indicator light comes on in the selected mode button.

Changing the mode cancels the automatic operation and the system goes into manual mode.

Press AUTO to return to automatic operation.

 : Air is directed to the windshield with some to the outboard instrument panel and side window outlets.

 : Air is directed to the instrument panel outlets.

 : Air is directed to the floor outlets, with some to the windshield, outboard instrument panel outlets, and side window outlets.

 **MAX** : Press to quickly clear the windshield of fog or frost. Air is directed to the windshield and the side window vents, with some air directed to the outboard instrument panel outlets. The system

automatically forces outside air into the vehicle and the air conditioning compressor will run, unless the outside temperature is close to or below freezing.

Do not drive the vehicle until all windows are clear.

See *Air Vents* ⇨ 107.

Heat : Press to turn the heater on or off. An indicator light comes on to show that the heater is enabled. If the fan is turned off, the heater will not run. Press AUTO to return to automatic operation.

A/C : Press to turn the air conditioning system on or off. An indicator light comes on to show that the air conditioning is enabled. If the fan is turned off, the air conditioner will not run. Press AUTO to return to automatic operation.

 : Press to turn on recirculation. An indicator light comes on. Air is recirculated to quickly cool the inside of the vehicle. It can also be used to help reduce outside air and odors that enter the vehicle. The air conditioning compressor also comes on when this mode is activated. Press AUTO to return to automatic operation.

Auto Defog : The climate control system may have a sensor to automatically detect high humidity inside the vehicle. When high humidity is detected, the climate control system will adjust air delivery modes, outside air supply, and turn on the air conditioner. If the climate control system does not detect possible window fogging, it returns to normal operation. To turn Auto Defog off or on, select Settings > Climate and Air Quality > Auto Defog > Select ON or OFF.

Heated Mirrors : If equipped with heated outside mirrors, the mirrors heat to help clear fog or frost from the surface of the mirror. See *Heated Mirrors* ⇨ 23.

Afterblow Feature

If equipped, under certain conditions, the fan may stay on or may turn on and off several times after you turn off and lock the vehicle. This is normal.

Air Vents

Adjustable air vents are in the center and on the side of the instrument panel. Use the sliding knobs on the air vents to change the direction of the airflow. Slide the knob up or down to open or close off the airflow.

Air vents blow warm air on the side windows in cold weather. If Floor, Defog, or Defrost modes are selected, a small amount of air will come from the vents close to the window. If the airflow is shut off using the sliding knobs, warm air will be directed to the other instrument panel vents. This is normal operation.

Use the sliding knobs to turn vent airflow on or off based on the mode selected.

Operation Tips

- Clear away any ice, snow, or leaves from air inlets at the base of the windshield that could block the flow of air into the vehicle.
- Clear snow off the hood to improve visibility and help decrease moisture drawn into the vehicle.
- Keep the path under the front seats clear of objects to help circulate the air inside of the vehicle more effectively.

- Use of non-GM approved hood deflectors can adversely affect the performance of the system. Check with your dealer before adding equipment to the outside of the vehicle.
- Do not attach any devices to the air vent slats. This will restrict airflow and may cause damage to the air vents.

Maintenance

Passenger Compartment Air Filter

The passenger compartment air filter reduces dust, pollen, and other airborne irritants from outside air that is pulled into the vehicle. Replace the filter periodically. See *Maintenance Schedule* ⇨ 229.

Using the climate control system without an air filter installed is not recommended. Water or other debris could enter the system and result in leaks or noises. Always install a new filter when removing the old filter.

For more information on filter replacement, see your dealer.

Service

All vehicles have a label underhood that identifies the refrigerant used in the vehicle. The refrigerant system should only be serviced by trained and certified technicians. The air conditioning evaporator should never be repaired or replaced by one from a salvage vehicle. It should only be replaced by a new evaporator to ensure proper and safe operation.

During service, all refrigerants should be reclaimed with proper equipment. Venting refrigerants directly to the atmosphere is harmful to the environment and may also create unsafe conditions based on inhalation, combustion, frostbite, or other health-based concerns.

The air conditioning system requires periodic maintenance. See *Maintenance Schedule* ⇨ 229.

Driving and Operating

Driving Information

Driving for Better Energy Efficiency	110
Distracted Driving	111
Defensive Driving	111
Impaired Driving	112
Control of a Vehicle	112
Braking	112
Steering	112
Off-Road Recovery	113
Loss of Control	113
Driving on Wet Roads	114
Hill and Mountain Roads	115
Winter Driving	115
If the Vehicle Is Stuck	116
Vehicle Load Limits	117

Starting and Operating

New Vehicle Break-In	120
Power Button	121
Starting and Stopping the Vehicle	122
Retained Accessory Power (RAP)	122
Shifting Into Park	123
Shifting out of Park	123
Extended Parking	124

Electric Drive Unit

Electric Drive Unit	124
One-Pedal Driving	127

Drive Systems

All-Wheel Drive	128
-----------------	-----

Brakes

Antilock Brake System (ABS)	128
Electric Parking Brake	129
Brake Assist	130
Hill Start Assist (HSA)	130
Automatic Vehicle Hold (AVH)	130
Regenerative Braking	131

Ride Control Systems

Traction Control/Electronic Stability Control	131
Driver Mode Control	132

Cruise Control

Cruise Control	133
Adaptive Cruise Control	134

Driver Assistance Systems

Driver Assistance Systems	144
Rear Vision Camera (RVC)	145
Surround Vision System	146
Park Assist	148
Reverse Automatic Braking (RAB)	149
Rear Cross Traffic Alert (RCTA) System	150
Assistance Systems for Driving	151
Forward Collision Alert (FCA) System	151
Automatic Emergency Braking (AEB)	153

Front Pedestrian Braking (FPB) System	154
Side Blind Zone Alert (SBZA)	156
Lane Change Alert (LCA)	156
Blind Zone Steering Assist (BZSA)	158
Lane Keep Assist (LKA)	158

Charging

When to Charge	160
Plug-In Charging	160
Delayed Charging Override	164
Charging Status Feedback	165
Utility Interruption of Charging	167
Electrical Requirements for Battery Charging	168

Trailer Towing

General Towing Information	168
----------------------------	-----

Conversions and Add-Ons

Add-On Electrical Equipment	168
-----------------------------	-----

Driving Information

Driving for Better Energy Efficiency

Use the tips in the categories below to help maximize energy efficiency and driving range.

In colder temperatures, while these efficiency tips will help, the driving range will be lower due to higher energy usage including energy spent heating the cabin.

The Energy Usage screen displays how energy is being used for the current drive since the last time the vehicle was started. See *Energy Information* ⇨ 72.

Acceleration/Braking/Coasting

Avoid rapid accelerations and decelerations.

Use cruise control when appropriate.

Plan ahead for decelerations and coast whenever possible. Do not rush to traffic signals. Do not shift to N (Neutral) to coast.

Use the One-Pedal Driving feature when appropriate to help recover energy during coasting and braking. This feature uses regenerative braking to slow the vehicle. One-Pedal mode recovers more energy while

coasting and braking than D (Drive) mode. See *One-Pedal Driving* ⇨ 127 and *Regenerative Braking* ⇨ 131.

Terrain and Vehicle Speed

Higher speeds and grade changes use more energy and can significantly reduce driving range.

Climate Setting

Using the heat and air conditioning systems decreases the energy available for electric driving. Optimal energy efficiency is achieved when the heat, air conditioning, and fan are turned off.

Use the heated seat and heated steering wheel features, if equipped, instead of the climate control system. Heating the seat and steering wheel uses less energy than heating and cooling the interior. See *Heated Front Seats* ⇨ 28.

Use the Remote Start feature to heat or cool the interior while the vehicle is plugged in, which uses electricity from the electrical outlet instead of using energy from the battery. See *Remote Vehicle Start* ⇨ 13.

In hot weather, avoid parking in direct sunlight. Use sunshades inside the vehicle.

Keep the inside of the windows clean to reduce fogging. Turn off the front defroster and rear defogger when they are not needed.

Avoid driving with the windows open at highway speeds.

Use the Battery Gauge on the Instrument Cluster to view the effect of climate control settings on your estimated driving range. See *Battery Gauge (High Voltage)* ⇨ 58.

Outside Temperature

On colder days, it is best to plug in the vehicle overnight, and then remote start the vehicle.

Allow the vehicle to warm up for 20 minutes before driving.

Vehicle Charging/Maintenance Charging

Keep the vehicle plugged in, even when fully charged, to maintain the battery temperature ready for the next drive. This is important when outside temperatures are extremely hot or cold.

If possible, use a Level 2 (240 volt) high power charge station for best results. This allows the interior of the vehicle and high voltage battery to warm to the optimal temperature.

Maintenance

Always keep the tires properly inflated and the vehicle properly aligned.

The weight of excess cargo in the vehicle affects efficiency and driving range. Avoid carrying more than is needed.

Avoid unnecessary use of electrical accessories. Power used for functions other than propelling the vehicle will reduce driving range.

Using a rooftop carrier will reduce efficiency due to additional weight and drag.

Distracted Driving

Distraction comes in many forms and can take your focus from the task of driving. Exercise good judgment and do not let other activities divert your attention away from the road. Many local governments have enacted laws regarding driver distraction. Become familiar with the local laws in your area.

To avoid distracted driving, keep your eyes on the road, keep your hands on the steering wheel, and focus your attention on driving.

- Do not use a phone in demanding driving situations. Use a hands-free method to place or receive necessary phone calls.
- Watch the road. Do not read, take notes, or look up information on phones or other electronic devices.
- Designate a front seat passenger to handle potential distractions.
- Become familiar with vehicle features before driving, such as programming favorite radio stations and adjusting climate control and seat settings. Program all trip information into any navigation device prior to driving.
- Wait until the vehicle is parked to retrieve items that have fallen to the floor.
- Stop or park the vehicle to tend to children.
- Keep pets in an appropriate carrier or restraint.
- Avoid stressful conversations while driving, whether with a passenger or on a cell phone.

Warning

Taking your eyes off the road too long or too often could cause a crash resulting in injury or death. Focus your attention on driving.

Refer to the infotainment section for more information on using that system and the navigation system, if equipped, including pairing and using a cell phone.

Defensive Driving

Defensive driving means “always expect the unexpected.” The first step in driving defensively is to wear the seat belt. See *Seat Belts* ⇨ 29.

- Assume that other road users (pedestrians, bicyclists, and other drivers) are going to be careless and make mistakes. Anticipate what they may do and be ready.
- Allow enough following distance between you and the driver in front of you.
- Focus on the task of driving.

Impaired Driving

Death and injury associated with impaired driving is a global tragedy.

Warning

Drinking alcohol or taking drugs and then driving is very dangerous. Your reflexes, perceptions, attentiveness, and judgment can be affected by even a small amount of alcohol or drugs. You can have a serious — or even fatal — collision if you drive after drinking or taking drugs.

Do not drive while under the influence of alcohol or drugs, or ride with a driver who has been drinking or is impaired by drugs. Find alternate transportation home; or if you are with a group, designate a driver who will remain sober.

Control of a Vehicle

Braking, steering, and accelerating are important factors in helping to control a vehicle while driving.

Braking

Braking action involves perception time and reaction time. Deciding to push the brake pedal is perception time. Actually doing it is reaction time.

Average driver reaction time is about three-quarters of a second. In that time, a vehicle moving at 100 km/h (60 mph) travels 20 m (66 ft), which could be a lot of distance in an emergency.

Helpful braking tips to keep in mind include:

- Keep enough distance between you and the vehicle in front of you.
- Avoid needless heavy braking.
- Keep pace with traffic.

Steering

Caution

To avoid damage to the steering system, do not drive over curbs, parking barriers, or similar objects at speeds greater than 3 km/h (1 mph). Use care when driving over other objects such as lane dividers and speed bumps. Damage caused by misuse of the vehicle is not covered by the vehicle warranty.



Electric Power Steering

The vehicle is equipped with an electric power steering system, which reduces the amount of effort needed to steer the vehicle. It does not have power steering fluid. Regular maintenance is not required.

If the vehicle experiences a system malfunction and loses power steering, greater steering effort may be required. Power steering assist also may be reduced if you turn the steering wheel as far as it can turn and hold it there with force for an extended period of time.

See your dealer if there is a problem.

Curve Tips

- Take curves at a reasonable speed.
- Reduce speed before entering a curve.
- Maintain a reasonable steady speed through the curve.
- Wait until the vehicle is out of the curve before accelerating gently into the straightaway.

Steering in Emergencies

- There are some situations when steering around a problem may be more effective than braking.
- Holding both sides of the steering wheel allows you to turn 180 degrees without removing a hand.
- Antilock Brake System (ABS) allows steering while braking.

Off-Road Recovery

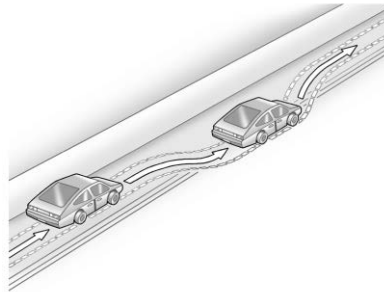

The vehicle's right wheels can drop off the edge of a road onto the shoulder while driving. Follow these tips:

1. Ease off the accelerator and then, if there is nothing in the way, steer the vehicle so that it straddles the edge of the pavement.
2. Turn the steering wheel about one-eighth of a turn, until the right front tire contacts the pavement edge.
3. Turn the steering wheel to go straight down the roadway.

Loss of Control

Skidding

There are three types of skids that correspond to the vehicle's three control systems:

- Braking Skid — wheels are not rolling.
- Steering or Cornering Skid — too much speed or steering in a curve causes tires to slip and lose cornering force.
- Acceleration Skid — too much throttle causes the driving wheels to spin.

Defensive drivers avoid most skids by taking reasonable care suited to existing conditions, and by not overdriving those conditions. But skids are always possible.

If the vehicle starts to slide, follow these suggestions:

- Ease your foot off the accelerator pedal and steer the way you want the vehicle to go. The vehicle may straighten out. Be ready for a second skid if it occurs.
- Slow down and adjust your driving according to weather conditions. Stopping distance can be longer and vehicle control can be affected when traction is reduced by water, snow, ice, gravel, or other material on the road. Learn to recognize

warning clues — such as enough water, ice, or packed snow on the road to make a mirrored surface — and slow down when you have any doubt.

- Try to avoid sudden steering, acceleration, or braking, including reducing vehicle speed by shifting to a lower gear. Any sudden changes could cause the tires to slide.

Remember: Antilock brakes help avoid only the braking skid.

Driving on Wet Roads

Rain and wet roads can reduce vehicle traction and affect your ability to stop and accelerate. Always drive slower in these types of driving conditions and avoid driving through large puddles and deep-standing or flowing water.

Warning

Wet brakes can cause crashes. They might not work as well in a quick stop and could cause pulling to one side. You could lose control of the vehicle.

(Continued)

Warning (Continued)

After driving through a large puddle of water or a car/vehicle wash, lightly apply the brake pedal until the brakes work normally.

Flowing or rushing water creates strong forces. Driving through flowing water could cause the vehicle to be carried away. If this happens, you and other vehicle occupants could drown. Do not ignore police warnings and be very cautious about trying to drive through flowing water.

Hydroplaning

Warning

Hydroplaning occurs when the vehicle tires lose contact with a wet road surface. If your vehicle hydroplanes, you can lose control and crash. You or others could be injured and/or your vehicle damaged. Reduce speed when driving on wet roads to avoid hydroplaning.

There is no hard and fast rule about hydroplaning. The best advice is to slow down when the road is wet.

Driving in Water

Warning

Driving through rushing water can be dangerous. Deep water can sweep your vehicle downstream and you and your passengers could drown. If it is only shallow water, it can still wash away the ground from under your tires. Traction could be lost, and the vehicle could roll over. Do not drive through rushing water.

Caution

Do not drive through standing water if it is deep enough to cover the wheel hubs or axles. Deep water can damage the axle and other vehicle parts.

Limit driving through standing water to no more than the bottom of the wheel rim and 10 km/hr (6 mph). At faster speeds, water can damage the vehicle. Do not turn off the

vehicle when driving through water. When going through water, the brakes get wet and it may take longer to stop.

Other Rainy Weather Tips

Besides slowing down, other wet weather driving tips include:

- Allow extra following distance.
- Pass with caution.
- Keep windshield wiping equipment in good shape.
- Keep the windshield washer fluid reservoir filled.
- Maintain your vehicle's tires and ensure they have proper tread depth. See *Tires* ⇨ 189.
- Turn off cruise control.

Hill and Mountain Roads

Driving on steep hills or through mountains is different than driving on flat or rolling terrain. Be sure to:

- Use regenerative braking to help slow the vehicle or maintain speed by keeping the vehicle in gear and limiting the initial battery charge to 80% or less. See *Regenerative Braking* ⇨ 131.

Warning

Do not charge your vehicle's battery above an 80% charge if you are going to drive down long, steep grades such as mountain passes. This provides room in the battery for regenerative braking to supplement your conventional brakes during the descent.

If the battery becomes full, regenerative braking will be limited or unavailable. The brakes will have to do all the work of slowing down the vehicle and could become too hot. Hot brakes may not be able to slow the vehicle enough to maintain speed and control. To help avoid the risk of a crash, limit the battery's charge and, if you experience brake fade or receive a brake warning, stop the vehicle and allow the brakes to cool.

See "Charge Now" under *Charging* ⇨ 66 for information on setting charge limits.

- When braking is necessary, use frequent light taps of the brake pedal. This maximizes regenerative braking and minimizes the load on the vehicle brake system.

- Keep the vehicle serviced and in good shape.
- Check all fluid levels, brakes, tires, and cooling system.
- Drive at speeds that keep the vehicle in its own lane. Do not swing wide or cross the center line.
- Be alert on top of hills where the road contour may reduce visibility in case anything unexpected is in your lane (e.g., stalled car, crash, debris).
- Pay attention to special road signs (e.g., falling rocks area, winding roads, long grades, passing or no-passing zones) and take appropriate action.

Winter Driving

Driving on Snow or Ice

Caution

To avoid damage to the wheels and brake components, always clear snow and ice from inside the wheels and underneath the vehicle before driving.

Snow or ice between the tires and the road creates less traction or grip, so drive carefully. Wet ice can occur at about

0 °C (32 °F) when freezing rain begins to fall. Avoid driving on wet ice or in freezing rain until roads can be treated.

For Slippery Road Driving:

- Turn off cruise control.
- If enabled, turn off One-Pedal Driving. See *One-Pedal Driving* ⇨ 127.
- Accelerate gently. Accelerating too quickly causes the wheels to spin and makes the surface under the tires slick.
- Allow greater following distance and watch for slippery spots. Icy patches can occur on otherwise clear roads in shaded areas. The surface of a curve or an overpass can remain icy when the surrounding roads are clear. Avoid sudden steering maneuvers and braking while on ice.
- The Antilock Brake System (ABS) improves vehicle stability during hard stops, but the brakes should be applied sooner than when on dry pavement. See *Antilock Brake System (ABS)* ⇨ 128.
- The Traction Control and Electronic Stability Control systems help limit wheel spin and assist the driver in maintaining control. These systems come on

automatically when the vehicle is started. See *Traction Control/Electronic Stability Control* ⇨ 131.

Blizzard Conditions

If you become stranded or cannot continue driving due to winter storm conditions, stop the vehicle in a safe place and signal for help. Stay with the vehicle unless there is help nearby.

If you stay in your vehicle while waiting, signal for help and keep everyone in the vehicle safe by turning on the hazard warning flashers and tying a red cloth to an outside mirror.

To conserve battery energy while waiting for help, run the vehicle for only short periods as needed to warm the vehicle and then shut the vehicle off and partially close the window. Moving about to keep warm also helps. For additional tips to help conserve battery energy in cold weather, see *Driving for Better Energy Efficiency* ⇨ 110.

If the Vehicle Is Stuck

Slowly and cautiously spin the wheels to free the vehicle when stuck in sand, mud, ice, or snow. See “Rocking the Vehicle to Get It Out” later in this section.

The Traction Control System (TCS) can often help to free a stuck vehicle. See *Traction Control/Electronic Stability Control* ⇨ 131. If TCS cannot free the vehicle, see “Rocking the Vehicle to Get it Out” following.

Warning

If the vehicle's tires spin at high speed, they can explode, and you or others could be injured. Spin the wheels as little as possible and avoid going above 56 km/h (35 mph).

For information about using tire chains on the vehicle, see *Tire Chains* ⇨ 204.

Rocking the Vehicle to Get It Out

Turn the steering wheel left and right to clear the area around the front wheels. Turn the TCS off. Shift back and forth between R (Reverse) and a forward gear, spinning the wheels as little as possible. To prevent electric drive unit wear, wait until the wheels stop spinning before shifting gears. Slowly spinning the wheels in the forward and reverse directions causes a rocking motion that could free the vehicle. If that

does not get the vehicle out after a few tries, it might need to be pulled out using the front tow eyes.

Front Tow Eyes

If equipped, use the front tow eyes to load the vehicle onto a flatbed tow truck from a flat road surface, or to move the vehicle a very short distance at a walking pace. The tow eyes are not designed for off-road recovery. See *Transporting a Disabled Vehicle* ⇨ 218.



Warning

Never pull on the tow eyes from the side. The tow eyes could break and you and others could be injured. When using the tow eyes, always pull the vehicle from the front.

Caution

Never use the tow eyes to tow the vehicle. The vehicle could be damaged, and the repairs would not be covered by the vehicle warranty.

Vehicle Load Limits

It is very important to know how much weight the vehicle can carry. This weight is called the vehicle capacity weight and includes the weight of all occupants, cargo, and all nonfactory-installed options. Two labels on the vehicle may show how much weight it was designed to carry: the Tire and Loading Information label and the Certification/Tire label.

Warning

Do not load the vehicle any heavier than the Gross Vehicle Weight Rating (GVWR), or either the maximum front or rear Gross Axle Weight Rating (GAWR). This can cause systems to break and change the way the vehicle handles. This could cause loss of control and a crash. Overloading can also reduce stopping performance, damage the tires, and shorten the life of the vehicle.

Tire and Loading Information Label

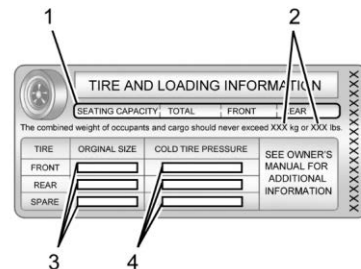

Label Example

A vehicle-specific Tire and Loading Information label is attached to the bulkhead wall in the interior of the vehicle. The Tire and Loading Information label shows the number of occupant seating positions (1), and the maximum vehicle capacity weight (2) in kilograms and pounds.

The Tire and Loading Information label also shows the size of the original equipment tires (3) and the recommended cold tire inflation pressures (4). For more information on tires and inflation see *Tires* ⇨ 189 and *Tire Pressure* ⇨ 194.

There is also important loading information on the vehicle Certification/Tire label. It may show the Gross Vehicle Weight Rating (GVWR) and the Gross Axle Weight Rating (GAWR) for the front and rear axles. See “Certification/Tire Label” later in this section.

Steps for Determining Correct Load Limit

1. Locate the statement "The combined weight of occupants and cargo should never exceed XXX kg or XXX lbs." on your vehicle's placard.
2. Determine the combined weight of the driver and passengers that will be riding in your vehicle.
3. Subtract the combined weight of the driver and passengers from XXX kg or XXX lbs.
4. The resulting figure equals the available amount of cargo and luggage load capacity. For example, if the "XXX" amount equals 1400 lbs. and there will be five 150 lb passengers in your vehicle, the amount of available cargo and luggage load capacity is 650 lbs. (1400-750 (5 x 150) = 650 lbs.)
5. Determine the combined weight of luggage and cargo being loaded on the vehicle. That weight may not safely exceed the available cargo and luggage load capacity calculated in Step 4.

6. If your vehicle will be towing a trailer, load from your trailer will be transferred to your vehicle. Consult this manual to determine how this reduces the available cargo and luggage load capacity of your vehicle."

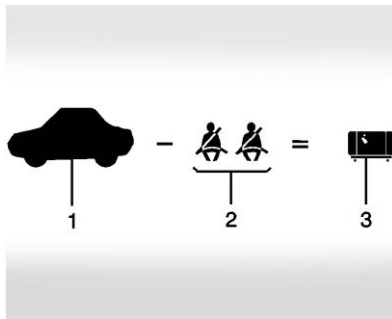

Example 1

1. Vehicle Capacity Weight for Example 1 = (453 kg) (1,000 lb)
2. Subtract Occupant Weight @ 68 kg (150 lb) × 2 = 136 kg (300 lb)
3. Available Occupant and Cargo Weight = 317 kg (700 lb)

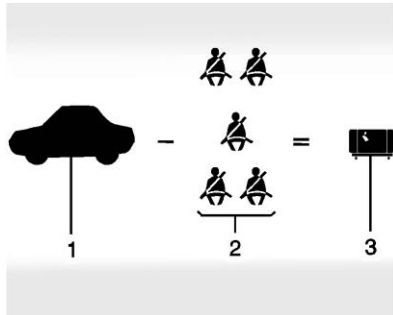

Example 2

1. Vehicle Capacity Weight for Example 2 = 453 kg (1,000 lb)
2. Subtract Occupant Weight @ 68 kg (150 lb) × 5 = 340 kg (750 lb)
3. Available Cargo Weight = 113 kg (250 lb)

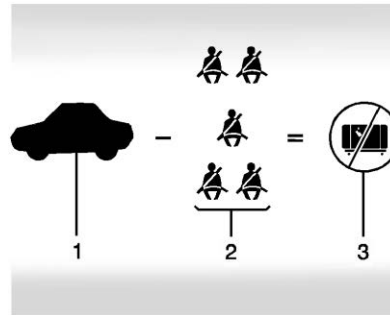

Example 3

1. Vehicle Capacity Weight for Example 3 = 453 kg (1,000 lb)
2. Subtract Occupant Weight @ 91 kg (200 lb) × 5 = 453 kg (1,000 lb)
3. Available Cargo Weight = 0 kg (0 lb)

Refer to the Tire and Loading Information label for specific information about the vehicle's capacity weight and seating positions. The combined weight of the driver, passengers, and cargo should never exceed the vehicle's capacity weight.

Certification/Tire Label

The form contains the following fields and labels:

- GVWR: KG / LB
- GAWR FRT: KG / LB
- GAWR RR: KG / LB
- TIRE SIZE:
- RIM:
- MODEL:
- FRT:
- RR:
- SPA:

A vehicle-specific Certification/Tire label is attached to the bulkhead wall in the interior of the vehicle. The label may show the size of the vehicle's original tires and the inflation pressures needed to obtain the gross weight capacity of the vehicle. This is called Gross Vehicle Weight Rating (GVWR). The GVWR includes the weight of the vehicle, all occupants, fuel, and cargo.

The Certification/Tire label also may show the maximum weights for the front and rear axles, called Gross Axle Weight Rating (GAWR). To determine

the actual loads on the front and rear axles, weigh the vehicle at a weigh station. Your dealer can help with this. Be sure to spread the load equally on both sides of the centerline.

The Certification/Tire label also contains important information about the Front Axle Reserve Capacity.

 **Warning**

In the case of a sudden stop or collision, things carried in the bed of your truck could shift forward and come into the passenger area, injuring you and others. If you put things in the bed of your truck, you should make sure they are properly secured.

Caution

Overloading the vehicle may cause damage. Repairs would not be covered by the vehicle warranty. Do not overload the vehicle.

Using heavier suspension components to get added durability might not change the weight ratings. Ask your dealer to help load the vehicle the right way.

 **Warning**

Things you put inside the vehicle can strike and injure people in a sudden stop or turn, or in a crash.

- Put things in the cargo area of the vehicle. Try to spread the weight evenly.
- Never stack heavier things, like suitcases, inside the vehicle so that some of them are above the tops of the seats.
- Do not leave an unsecured child restraint in the vehicle.
- When you carry something inside the vehicle, secure it whenever you can.
- Do not leave a seat folded down unless you need to.

Add-On Equipment

Your vehicle may be equipped with aftermarket storage products. Consult with the original manufacturer for proper usage.

Caution

Overloading the vehicle may cause damage. Repairs would not be covered by the vehicle warranty. Do not overload the vehicle.

Starting and Operating

New Vehicle Break-In

Caution

Avoid making hard stops for the first 322 km (200 mi). During this time the new brake linings are not yet broken in. Hard stops with new linings can mean premature wear and earlier replacement. Follow this breaking-in guideline every time you get new brake linings. Following break-in, vehicle speed and load can be gradually increased.

Power Button



The vehicle has an electronic pushbutton start.

The remote key must be in the vehicle for the system to operate. If the vehicle will not start, place the remote key in the transmitter pocket. See *Remote Key Operation* ⇨ 7.

ON/RUN : This position is for starting and driving. With the vehicle off, and the brake pedal applied, pressing POWER ⏻ once will place the vehicle in ON/RUN. When the vehicle ready light is on in the instrument cluster, the vehicle is ready to be driven. This could take up to 15 seconds at extremely cold temperatures.

Service Mode

This power mode is available for service and diagnostics, and to verify the proper operation of the service vehicle soon light as may be required for emission inspection purposes. With the vehicle off, and the brake pedal not applied, pressing and holding POWER ⏻ for more than five seconds will place the vehicle in Service Mode. The instruments and audio systems will operate as they do in ON/RUN, but the vehicle will not be able to be driven. The propulsion system will not start in Service Mode. Press POWER ⏻ again to turn the vehicle off.

Caution

Placing the vehicle in Service Mode will use the 12-volt battery. Do not use Service Mode for an extended period, or the vehicle may not start.

Accessory Mode (Amber Indicator)

This mode allows you to use some electrical accessories when the propulsion system is off. With the vehicle off, pressing POWER ⏻ once without the brake pedal applied will place the vehicle in accessory mode. The

vehicle will switch from accessory mode to off after 30 seconds to prevent 12-volt battery rundown.

STOPPING THE VEHICLE/OFF : To turn the vehicle off, apply the brakes, press the button on top of the shift lever to shift to P (Park) and press POWER ⏻.

Alternatively, apply the brakes and press POWER ⏻. The electric drive unit will shift to P (Park) then shut off automatically.

Retained Accessory Power (RAP) will remain active until the driver door is opened.

If the vehicle must be shut off in an emergency:

1. Brake using a firm and steady pressure. Do not pump the brakes repeatedly. This may deplete power assist, requiring increased brake pedal force.
2. Shift the vehicle to N (Neutral). This can be done while the vehicle is moving. After shifting to N (Neutral), firmly apply the brakes and steer the vehicle to a safe location.
3. Come to a complete stop, shift to P (Park), and turn the vehicle off by pressing POWER ⏻.
4. Set the parking brake.

Warning

Turning off the vehicle while moving may disable the airbags. While driving, only shut the propulsion system off in an emergency.

If the vehicle cannot be pulled over, and must be shut off while driving, press and hold POWER  for longer than two seconds, or press twice in five seconds.

Starting and Stopping the Vehicle**Starting Procedure**

Press the P (Park) button on the shift lever, or move the shift lever into N (Neutral). The propulsion system will not start in any other position.

Caution

Do not try to shift to P (Park) if the vehicle is moving or the electric drive unit could be damaged. Shift to P (Park) only when the vehicle is stopped.

Caution

If you add electrical parts or accessories, you could change the way the vehicle operates. Any resulting damage would not be covered by the vehicle warranty.

The remote key must be in the vehicle. Press the brake pedal, then press and release POWER .

If the remote key is not in the vehicle or something is interfering with the remote key, a message displays in the Driver Information Center (DIC).

If the vehicle will not start due to a low remote key battery, the vehicle can still be driven. See *Remote Key Operation* ⇨ 7.



A vehicle ready light displays in the lower right corner of the instrument cluster when the vehicle is ready to be driven.

The instrument cluster also displays an active battery gauge when the vehicle is ready to be driven.

Restarting Procedure

If the vehicle must be restarted while it is still moving, move the shift lever to N (Neutral) and press POWER  twice without pressing the brake pedal. The propulsion system will not restart in any other position.

Always press POWER  to turn the vehicle off before exiting.

Stopping Procedure

For information on how to turn the vehicle off, see *Power Button* ⇨ 121.

Retained Accessory Power (RAP)

When the vehicle is turned from on to off, the following features (if equipped) will continue to function for up to 10 minutes, or until the driver door is opened.

- Infotainment System
- Power Windows (during RAP this functionality will be lost when any door is opened)

- Sunroof (during RAP this functionality will be lost when any door is opened)
- Auxiliary Power Outlet
- Audio System
- OnStar System

Shifting Into Park

To shift into P (Park):

1. Hold the brake pedal down and set the parking brake. See *Electric Parking Brake* ⇨ 129.
2. Press the P (Park) switch on the front of the shift lever. See *Electric Drive Unit* ⇨ 124.
3. The P indicator on the shift lever will turn red when the vehicle is in P (Park).
4. Turn the vehicle off.

If the vehicle is shifted into P (Park) on a hill, the electric parking brake (EPB) may apply automatically. The driver may not be able to release the EPB using the EPB switch. It should automatically release when the vehicle is shifted out of P (Park).

Leaving the Vehicle with the Propulsion System On

Warning

It is dangerous to get out of the vehicle if the vehicle is not in P (Park) with the parking brake set. The vehicle can roll.

Do not leave the vehicle when the propulsion system is on. If you have left the propulsion system on, the vehicle can move suddenly. You or others could be injured. To be sure the vehicle will not move, even when you are on fairly level ground, always set the parking brake and press the P (Park) button. See *Shifting Into Park* ⇨ 123.

If the vehicle must be left with the propulsion system on, be sure that the vehicle is in P (Park) with the parking brake set, before leaving the vehicle. After pressing the P (Park) button, hold down the regular brake pedal. If you cannot see the P (Park) indicator in the instrument cluster, it means that the vehicle has not shifted to P (Park).

Shifting out of Park

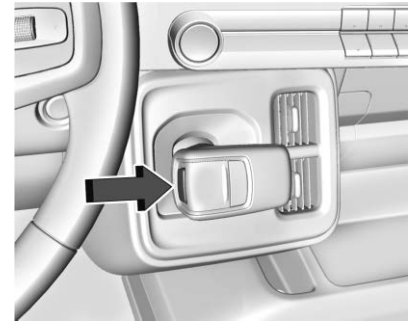

This vehicle is equipped with an electric drive unit. The shift lock release button is designed to prevent inadvertent shifting out of P (Park). To shift out of P (Park) the vehicle must be on, the brake pedal applied, the shift lock release button pressed, and the charge cord unplugged.

Parking the vehicle in extreme cold for several days without the charge cord connected may cause the vehicle to not start. Plug the vehicle in to allow the high voltage battery to be warmed sufficiently.

To shift out of P (Park):

1. Apply the brake pedal.
2. Press POWER  to start the vehicle.
3. Verify that the vehicle is unplugged and the vehicle ready light is on.
4. Press the shift lock release button.
5. Move the shift lever to the desired position.

After releasing the shift lever, it will return to the center position.

The P indicator will turn white and the gear indicator on the shift lever will turn red when the vehicle is no longer in P (Park).

If the vehicle cannot shift from P (Park), a Driver Information Center (DIC) message may be displayed. Check that the vehicle is on, the vehicle ready light is on, and the brake pedal is applied when you are attempting to shift out of P (Park). If all of these conditions are met but the vehicle will not shift out of P (Park), see your dealer for service.

If equipped, the Buckle to Drive feature may prevent shifting from P (Park). See *Buckle To Drive* ⇨ 30.

Extended Parking

It is best not to park with the propulsion system on. If the vehicle is left on, be sure it will not move.

See *Shifting Into Park* ⇨ 123.

If the vehicle is left parked and on with the remote key outside the vehicle, it will remain on for up to one hour.

If the vehicle is left parked and on with the remote key inside the vehicle, it will remain on for up to two hours.

The timer will reset if the vehicle is taken out of P (Park) while it is on.

Electric Drive Unit



The vehicle uses an electric drive unit. The shift lever is on the center stack. The shift pattern is displayed on the front of the shift lever. The selected gear position illuminates red on the shift lever, while all others will be displayed in white. If the shift is not immediate, as in very cold conditions, the indicator on the shift switch may blink until it is fully engaged.

If POWER  is pressed twice while at a relatively high speed, the vehicle will turn off and automatically shift to N (Neutral). Once the vehicle is stopped, P (Park) can be selected.

P : This position locks the drive wheels. Use P (Park) when starting the vehicle to prevent the vehicle from moving easily.

Warning

It is dangerous to get out of the vehicle if the vehicle is not in P (Park) with the parking brake set. The vehicle can roll.

Do not leave the vehicle when the propulsion system is on. If you have left the propulsion system on, the vehicle can move suddenly. You or others could be injured. To be sure the vehicle will not move, even when you are on fairly level ground, always set the parking brake and press the P (Park) button. See *Shifting Into Park* ⇨ 123.

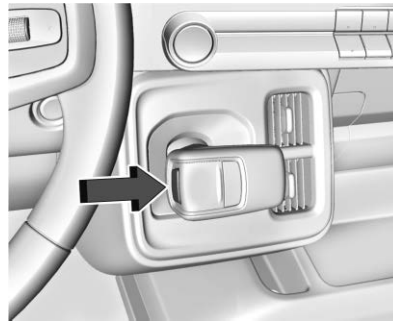

The shift lock release button is designed to prevent inadvertent shifting out of P (Park) unless the vehicle is on, the brake pedal is applied, and the shift lock release button is pressed.

When the vehicle is stopped, press POWER  to turn off the vehicle. The vehicle will shift to P (Park) automatically unless the vehicle is in N (Neutral), see “Car Wash Mode” later in this section.

The vehicle will not shift into P (Park) if it is moving too fast. Stop the vehicle and shift into P (Park).

To shift in and out of P (Park), see *Shifting Into Park* ⇨ 123 and *Shifting out of Park* ⇨ 123.

R : Use this gear to back up.

If the vehicle is shifted from either R (Reverse) to D (Drive) or L (Low), or D (Drive) or L (Low) to R (Reverse) while the speed is too high, the vehicle may shift to N (Neutral). Reduce the vehicle speed and try the shift again.

To shift into R (Reverse):

1. Bring the vehicle to a complete stop.
2. Press and hold the shift lock release button on the side of the shift lever.
3. From the center position, move the shift lever up to R (Reverse). R will be illuminated in red.
4. After releasing the shift lever, it will return to the center position.

To shift out of R (Reverse):

1. Bring the vehicle to a complete stop.
2. Shift to the desired gear.
3. After releasing the shift lever, it will return to the center position.

At low vehicle speeds, R (Reverse) can be used to rock the vehicle back and forth to get out of snow, ice, or sand without damaging the electric drive unit. See *If the Vehicle Is Stuck* ⇨ 116.

N : In this position, the propulsion system is inactive. If the vehicle is moving and turned off, restart the propulsion system in N (Neutral) only.

Caution

The vehicle is not designed to stay in N (Neutral) for extended periods of time. It will automatically shift into P (Park).

To shift into N (Neutral):

1. From the center position, move the shift lever up to N (Neutral).
 - If the vehicle is in P (Park), apply the brake pedal and press the shift lock release button while moving the shift lever up.
 - The N indicator will illuminate in red.
2. After releasing the shift lever, it will return to the center position.

To shift out of N (Neutral):

1. Bring the vehicle to a complete stop.
2. Hold the brake pedal down.
3. Shift to the desired gear.

If the brake pedal is not applied, the vehicle may remain in N (Neutral).

Car Wash Mode

This vehicle includes a Car Wash Mode that allows the vehicle to remain in N (Neutral) for use in automatic car washes.

Car Wash Mode is not to be used for vehicle towing. If the vehicle needs to be towed, see *Transporting a Disabled Vehicle* ⇨ 218.

Caution

The vehicle is not designed to stay in N (Neutral) for extended periods of time. It will automatically shift into P (Park) if left in Car Wash Mode.

Car Wash Mode (Vehicle Off) – Driver In Vehicle

To place the vehicle in N (Neutral) with the vehicle off and occupied:

1. Drive to the entrance of the car wash.
2. Apply the brake pedal.
3. Shift to N (Neutral).
4. Turn off the vehicle and release the brake pedal.
5. The indicator should continue to show N. If it does not, turn the vehicle on and repeat Steps 2–4.

6. The vehicle is now ready for the car wash.

Car Wash Mode (Vehicle Off) – Driver Out of Vehicle

To place the vehicle in N (Neutral) with the vehicle off and unoccupied:

1. Drive to the entrance of the car wash.
2. Apply the brake pedal.
3. Open the door.
4. Shift to N (Neutral).
5. Turn off the vehicle and release the brake pedal.
6. The indicator should continue to show N. If it does not, turn the vehicle on and repeat Steps 2–5.
7. Exit the vehicle and close the door. The vehicle is now ready for the car wash.
8. The vehicle may automatically shift into P (Park) upon reentry.

Car Wash Mode (Vehicle On) – Driver In Vehicle

To place the vehicle in N (Neutral) with the vehicle on and occupied:

1. Drive to the entrance of the car wash.
2. Apply the brake pedal.

- Shift to N (Neutral).
- Release the brake pedal.
- The vehicle is now ready for the car wash.

Car Wash Mode (Vehicle On) – Driver Out of Vehicle

To place the vehicle in N (Neutral) with the vehicle on and unoccupied:

- Drive to the entrance of the car wash.
- Apply the brake pedal.
- Open the door.
- Shift to N (Neutral). Then release the brake pedal.
- The indicator should continue to show N. If it does not, repeat Steps 2–4.
- Exit the vehicle and close the door. The vehicle is now ready for the car wash.
- The vehicle may automatically shift into P (Park) upon reentry.

D : This position is for normal driving. If more power is needed for passing, press the accelerator pedal down.

To shift into D (Drive):

- Bring the vehicle to a complete stop.

- From the center position, move the shift lever down.
 - If the vehicle is in P (Park), press the shift lock release button while pulling the shift lever back.
 - D will illuminate in red.
- After releasing the shift lever, it will return to the center position.

To shift out of D (Drive):

- Bring the vehicle to a complete stop.
- Shift to the desired gear.

Caution

Spinning the tires excessively may damage the electric drive unit. The repair will not be covered by the vehicle warranty. If you are stuck, do not spin the tires.

When stopping on a hill, use the brakes to hold the vehicle in place.

When shifting to P (Park) on a hill, use the brakes to hold the vehicle then shift to P (Park).

L : This position provides additional coast braking for driving downhill or hauling a heavy load.

To use this feature:

- Ensure the vehicle is in D (Drive).
- From the center position, move the shift lever down.
After releasing the shift lever, it will return to the center position

To exit L (Low) and shift into D (Drive) or N (Neutral): At any speed, shift to D (Drive) or N (Neutral).

To exit L (Low) and shift into P (Park) or R (Reverse):

- Bring the vehicle to a complete stop.
- Shift to the desired gear.

Cruise control can be used while the vehicle is in L (Low) Mode.

One-Pedal Driving

With One-Pedal Driving, the accelerator pedal is used to control the vehicle deceleration to a complete stop. Completely lifting off the accelerator pedal will result in aggressive deceleration. Partially lifting off the accelerator pedal allows you to adjust deceleration as desired.

Use the brake pedal for emergency braking.

To view and configure One-Pedal Driving, from the infotainment display home screen, select Settings > Vehicle > One-Pedal Driving.

Select “Off” to disable One-Pedal Driving for traditional two-pedal driving, similar to a gasoline vehicle.

Select “On” to enable One-Pedal Driving where a moderate level of braking is applied when the accelerator pedal is released while driving.

Select “High” to enable One-Pedal Driving where a strong level of braking is applied when the accelerator pedal is released while driving.

This feature remains enabled until manually disabled by the driver. Press the accelerator pedal to the desired speed. The brake lamps will come on during substantial deceleration and when the vehicle is stopped.

If One-Pedal Driving is turned off while stopped, the vehicle will remain stationary. Press the brake pedal or accelerator pedal to return to two-pedal driving.

When possible, One-Pedal Driving uses regenerative braking to slow the vehicle for energy efficiency. Friction brakes are used when regenerative braking is reduced.

Friction brakes will be used to hold the vehicle after coming to a stop. You may notice a noise when the brakes apply.

Turn off One-Pedal Driving on slippery roads. See *Winter Driving* ⇨ 115.

While operating in One-Pedal Driving, the Electric Parking Brake may apply in some circumstances. This can occur when:

- The driver exits the vehicle.
- The vehicle remains stationary for several minutes.

To drive again, press the accelerator pedal, and the Electric Parking Brake automatically disengages.

Drive Systems

All-Wheel Drive

This vehicle may be equipped with advanced electric All-Wheel Drive (eAWD). The eAWD system delivers power to all four wheels, and the system adjusts automatically to the driving conditions. The eAWD system continuously varies the drive power to the front and rear wheels to maximize driving efficiency and improve driving dynamics. Your vehicle has exceptional driving

capability, but care must always be taken to adjust driving style to the traffic and road conditions.

The vehicle eAWD settings may be customized for the driver mode selected. See *Driver Mode Control* ⇨ 132 for more information.

Brakes

Antilock Brake System (ABS)

The Antilock Brake System (ABS) helps prevent a braking skid and maintain steering while braking hard.



If there is a problem with ABS, this warning light stays on. See *Antilock Brake System (ABS) Warning Light* ⇨ 62.

ABS does not change the time needed to get a foot on the brake pedal and does not always decrease stopping distance. If you get too close to the vehicle ahead, there will not be enough time to apply the brakes if

that vehicle suddenly slows or stops. Always leave enough room ahead to stop, even with ABS.

Using ABS

Do not pump the brakes. Just hold the brake pedal down firmly. Hearing and feeling ABS operate is normal.

Braking in Emergencies

ABS allows steering and braking at the same time. In many emergencies, steering can help even more than braking.

Electric Parking Brake

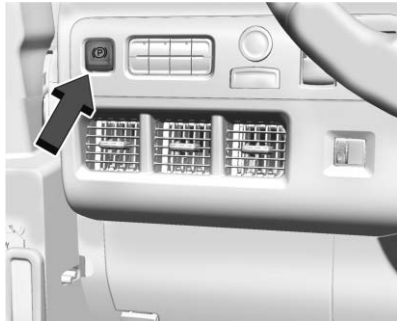

The Electric Parking Brake (EPB) can always be applied, even if the vehicle is off. In case of insufficient electrical power, the EPB cannot be applied or released. To prevent draining the battery, avoid unnecessary repeated cycles of the EPB.

The system has a red parking brake status light and an amber service parking brake warning light. See *Electric Parking Brake Light* ⇨ 61 and *Service Electric Parking Brake Light* ⇨ 61. There are also parking brake-related Driver Information Center (DIC) messages.

Before leaving the vehicle, check the red parking brake status light to ensure that the parking brake is applied.

EPB Apply

To apply the EPB:

1. Be sure the vehicle is at a complete stop.
2. Press the EPB switch momentarily.

The red parking brake status light will flash and then stay on once the EPB is fully applied. If the red parking brake status light flashes continuously, then the EPB is only partially applied or there is a problem with the EPB. A DIC message will display. Release the EPB and try to apply it again. If the

light does not come on, or keeps flashing, have the vehicle serviced. Do not drive the vehicle if the red parking brake status light is flashing. See your dealer.

If the amber service parking brake warning light is on, press the EPB switch. Continue to hold the switch until the red parking brake status light remains on. If the amber service parking brake warning light is on, see your dealer.

If the EPB is applied while the vehicle is moving, the vehicle will decelerate as long as the switch is pressed. If the switch is pressed until the vehicle comes to a stop, the EPB will remain applied.

The vehicle may automatically apply the EPB in some situations when the vehicle is not moving. This is normal, and is done to periodically check the correct operation of the EPB system, or at the request of other safety functions that utilize the EPB.

If the EPB fails to apply, block the rear wheels to prevent vehicle movement.

EPB Release

To release the EPB:

1. Turn the ignition on.
2. Apply and hold the brake pedal.

3. Press the EPB switch momentarily.

The EPB is released when the red parking brake status light is off.

If the amber service parking brake warning light is on, release the EPB by pressing and holding the EPB switch. Continue to hold the switch until the red parking brake status light is off. If either light stays on after release is attempted, see your dealer.

Caution

Driving with the parking brake on can overheat the brake system and cause premature wear or damage to brake system parts. Make sure that the parking brake is fully released and the brake warning light is off before driving.

Automatic EPB Release

The EPB will automatically release if the vehicle is running, placed into gear, and an attempt is made to drive away. Avoid rapid acceleration when the EPB is applied, to preserve parking brake lining life.

Brake Assist

Brake Assist detects rapid brake pedal applications due to emergency braking situations and provides additional braking to activate the Antilock Brake System (ABS) if the brake pedal is not pushed hard enough to activate ABS normally. Minor noise, brake pedal pulsation, and/or pedal movement during this time may occur. Continue to apply the brake pedal as the driving situation dictates. Brake Assist disengages when the brake pedal is released.

Hill Start Assist (HSA)

Warning

Do not rely on the HSA feature. HSA does not replace the need to pay attention and drive safely. You may not hear or feel alerts or warnings provided by this system. Failure to use proper care when driving may result in injury, death, or vehicle damage. See *Defensive Driving* ⇨ 111.

When the vehicle is stopped on a grade, Hill Start Assist (HSA) prevents the vehicle from rolling in an unintended direction during the transition from brake pedal release to

accelerator pedal apply. The brakes release when the accelerator pedal is applied. If the accelerator pedal is not applied within a few minutes, the Electric Parking Brake will apply. The brakes may also release under other conditions. Do not rely on HSA to hold the vehicle.

HSA is available when the vehicle is facing uphill in a forward gear, or when facing downhill in R (Reverse). The vehicle must come to a complete stop on a grade for HSA to activate.

Automatic Vehicle Hold (AVH)



⚠ Warning

Do not rely on this feature. It does not replace the need to pay attention and drive safely. You may not hear or feel alerts or warnings provided by this system. Failure to use proper care when driving may result in injury, death, or vehicle damage.

When Automatic Vehicle Hold (AVH) is turned on and the vehicle is braked to a stop, AVH prevents the vehicle from moving during the transition from brake pedal release to accelerator pedal apply. The brakes release when the accelerator pedal is applied. The brakes may also release under other conditions. Do not rely on AVH to hold the vehicle.

If the accelerator pedal is not applied within a few minutes, the Electric Parking Brake will apply. The parking brake will also apply if the driver door is opened or the driver seat belt is unfastened while AVH is holding the vehicle.

AVH can be turned on by pressing AUTO HOLD. The AVH indicator will come on. While AVH is holding the vehicle, the AVH indicator will change to green. See *Automatic Vehicle Hold (AVH) Light* ⇨ 62.

Regenerative Braking

Regenerative braking takes some of the energy from the moving vehicle and turns it back into electrical energy. This energy is then stored back into the high voltage battery system, contributing to increased energy efficiency.

Regenerative power may be limited when the battery is near full charge or cold. See “Regenerative Power Limited” under *Power Indicator Gauge* ⇨ 59. Regenerative braking supplements your vehicle’s conventional brakes, especially when going downhill. See *Hill and Mountain Roads* ⇨ 115.

⚠ Warning

Do not charge your vehicle’s battery above an 80% charge if you are going to drive down long, steep grades such as mountain passes. This provides room in the battery for regenerative braking to supplement your conventional brakes

(Continued)

Warning (Continued)

during the descent. This is especially important when towing a trailer, which puts additional stress on your vehicle’s braking system.

See “Charge Now” under *Charging* ⇨ 66 for information on setting charge limits. See *Hill and Mountain Roads* ⇨ 115 for important information about driving on grades.

The brake system uses regenerative braking, conventional hydraulic braking, or a combination of both as appropriate.

Ride Control Systems**Traction Control/Electronic Stability Control****System Operation**

The vehicle has a Traction Control System (TCS) and StabiliTrak/Electronic Stability Control (ESC). These systems help limit wheel spin and assist the driver in maintaining control, especially on slippery road conditions.

TCS activates if it senses any of the drive wheels are spinning or beginning to lose traction. When this happens, TCS applies the brakes to the spinning wheels and reduces vehicle power to limit wheel spin.

StabiliTrak/ESC activates when the vehicle senses a difference between the intended path and the direction the vehicle is actually traveling. StabiliTrak/ESC selectively applies braking pressure to one or more of the vehicle wheel brakes to assist the driver in keeping the vehicle on the intended path.

If cruise control is being used and traction control or StabiliTrak/ESC begins to limit wheel spin, cruise control will disengage. Cruise control may be turned back on when road conditions allow.

Both systems come on automatically when the vehicle is started and begins to move. The systems may be heard or felt while they are operating or while performing diagnostic checks. This is normal and does not mean there is a problem with the vehicle.



The indicator light for both systems is in the instrument cluster. This light will:

- Flash when TCS is limiting wheel spin
- Flash when StabiliTrak/ESC is activated
- Turn on and stay on when either system is not working

See *Traction Control System (TCS)/StabiliTrak Light* ⇨ 64.

If either system fails to turn on or to activate, a message displays in the Driver Information Center (DIC), and  comes on and stays on to indicate that the system is inactive and is not assisting the driver in maintaining control. Adjust driving accordingly.

If  comes on and stays on, see your dealer as soon as possible.

Driver Mode Control

Delivery Mode

Press the following button to turn on Delivery mode.

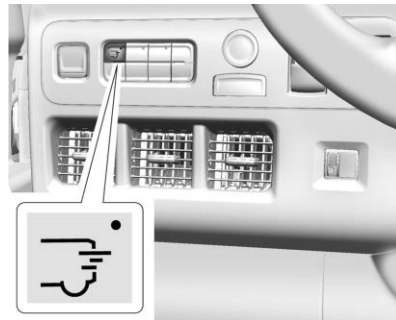

After pressing the Delivery mode button and shifting the vehicle into P (Park), the vehicle automatically turns on the cabin lights and unlocks the rear bulkhead door for about 15 seconds. If equipped with the auto-open system, the rear bulkhead door will auto-open when the transmission is shifted into P (Park). See *Sliding Door (Bulkhead Door)* ⇨ 16.

Once the vehicle shifts out of P (Park), the cabin lights turn off and the horn sounds an alert to those nearby that the vehicle is departing.

If the Delivery mode button is pressed but the vehicle is not shifted into P (Park), the cabin lights will automatically turn off to preserve battery life.

Cruise Control

Warning

Cruise control can be dangerous where you cannot drive safely at a steady speed. Do not use cruise control on winding roads or in heavy traffic.

Cruise control can be dangerous on slippery roads. On such roads, fast changes in tire traction can cause excessive wheel slip, and you could lose control. Do not use cruise control on slippery roads.

If equipped with cruise control, a speed of about 40 km/h (25 mph) or more can be maintained without keeping your foot on the accelerator. Cruise control does not work at speeds below about 40 km/h (25 mph).

If the Traction Control System (TCS) or StabiliTrak/Electronic Stability Control (ESC) system begins to limit wheel spin while using cruise control, the cruise control automatically disengages. See *Traction Control/Electronic Stability Control* ⇨ 131. When road conditions allow you to safely use it again, cruise control can be turned back on.

If the brakes are applied, cruise control disengages.

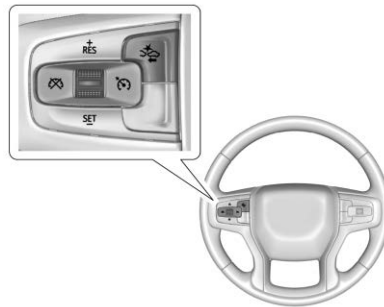



 : Press to turn cruise control on or off. The white indicator comes on in the instrument cluster when cruise control is turned on.

+RES : If there is a set speed in memory, press briefly to resume that speed or press and hold to accelerate. If cruise control is already active, use to increase vehicle speed.

SET- : Press briefly to set the speed and activate cruise control. If cruise control is already active, use to decrease vehicle speed.

 : Press to disengage cruise control without erasing the set speed from memory.

Setting Cruise Control

If  is on when not in use, the SET- or +RES button could get pressed and go into cruise when not desired. Keep  off when cruise is not being used.

To set a speed:

1. Press  to turn the cruise system on.
2. Get up to the desired speed.
3. Press and release SET-.
4. Remove your foot from the accelerator.

The cruise control indicator on the instrument cluster turns green after cruise control has been set to the desired speed. See *Instrument Cluster* ⇨ 55.

Resuming a Set Speed

If the cruise control is set at a desired speed and then the brakes are applied or  is pressed, the cruise control is disengaged without erasing the set speed from memory.

Once the vehicle speed reaches about 40 km/h (25 mph) or more, briefly press +RES. The vehicle returns to the previous set speed.

Increasing Speed While Using Cruise Control

If the cruise control system is already activated:

- Press and hold +RES until the desired speed is reached, then release it.
- To increase vehicle speed in small increments, briefly press +RES. For each press, the vehicle goes about 1 km/h (Metric display) or 1 mph (English display) faster.

The speedometer reading can be displayed in either English or metric units. See *Driver Information Center (DIC)* ⇨ 72. The increment value used depends on the units displayed.

Reducing Speed While Using Cruise Control

If the cruise control system is already activated:

- Press and hold SET- until the desired lower speed is reached, then release it.
- To slow down in small increments, briefly press SET-. For each press, the vehicle goes about 1 km/h (Metric display) or 1 mph (English display) slower.

The speedometer reading can be displayed in either English or metric units. See *Driver Information Center (DIC)* ⇨ 72. The increment value used depends on the units displayed.

Passing Another Vehicle While Using Cruise Control

Use the accelerator pedal to increase the vehicle speed. When you take your foot off the pedal, the vehicle will slow down to the previous set cruise speed. While pressing the accelerator pedal or shortly following the release to override cruise control, briefly pressing SET- will result in cruise set to the current vehicle speed.

Using Cruise Control on Hills



How well the cruise control works on hills depends on the vehicle speed, load, and the steepness of the hills. When going up steep

hills, you might have to step on the accelerator pedal to maintain the vehicle speed. When going downhill, you might have to brake or shift to a lower gear to keep your speed down.

If the brake pedal is applied, cruise control will disengage.

Ending Cruise Control

There are four ways to end cruise control:

- Step lightly on the brake pedal.
- Press .
- Shift the electric drive unit to N (Neutral).
- To turn off cruise control, press .

Erasing Speed Memory

The cruise control set speed is erased from memory if  is pressed or if the vehicle is turned off.

Adaptive Cruise Control

If equipped, Adaptive Cruise Control (ACC) allows the cruise control set speed and following gap to be selected. Read this entire section before using this system. The following gap is the following time between your vehicle and a vehicle detected directly ahead in your path, moving in the same

direction. If no vehicle is detected in your path, ACC works like regular cruise control. ACC uses a camera and radar sensor(s) to detect other vehicles.

If a vehicle is detected in your path, ACC can apply acceleration or limited, moderate braking to maintain the selected following gap. To disengage ACC, apply the brake. If ACC is controlling the vehicle speed when the Traction Control System (TCS) or StabiliTrak/Electronic Stability Control (ESC) system activates, ACC may automatically disengage. See *Traction Control/Electronic Stability Control* ⇨ 131. When road conditions allow ACC to be safely used, ACC can be turned back on. Disabling the TCS or StabiliTrak/ESC system will disengage and prevent engagement of ACC.

ACC can reduce the need for you to frequently brake and accelerate, especially when used on expressways, freeways, and interstate highways. When used on other roads, you may need to take over the control of braking or acceleration more often.

ACC automatically slows the vehicle down while navigating the curve and may increase speed out of the curve, but will not exceed the set speed.

Warning

ACC has limited braking ability and may not have time to slow the vehicle down enough to avoid a collision with another vehicle you are following. This can occur when vehicles suddenly slow or stop ahead, or enter your lane. Also see “Alerting the Driver” later in this section. Complete attention is always required while driving and you should be ready to take action and apply the brakes. See *Defensive Driving* ⇨ 111.

Warning

ACC will not detect or brake for children, pedestrians, animals, or other objects.

Do not use ACC when:

- On winding and hilly roads or when the camera sensor is blocked by snow, ice, or dirt. The system may not detect a vehicle ahead. Keep the windshield and headlamps clean.
- When visibility is poor due to rain, snow, fog, dirt, insect residue, or dust; when other foreign objects obscure

(Continued)

Warning (Continued)

the camera’s view; or when the vehicle in front or oncoming traffic causes additional environmental obstructions, such as road spray. ACC performance is limited under these conditions.

- On slippery roads where fast changes in tire traction can cause excessive wheel slip
- With extremely heavy cargo loaded in the cargo area or rear seat
- When towing a trailer

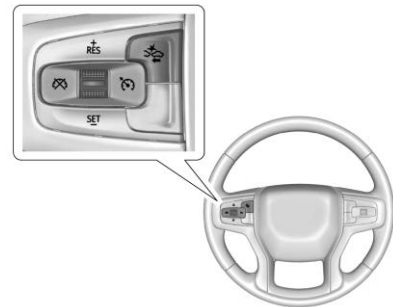

 : Press to turn the system on or off. The indicator turns white on the instrument cluster when ACC is turned on.

RES+ : Press briefly to resume the previous set speed or to increase vehicle speed if ACC is already activated. To increase speed by about 1 km/h (1 mph), press RES+ briefly. To increase speed to the next 5 km/h (5 mph) mark on the speedometer, hold RES+.

SET- : Press briefly to set the speed and activate ACC or to decrease vehicle speed if ACC is already activated. To decrease speed by about 1 km/h (1 mph), press SET- briefly. To decrease speed to the next 5 km/h (5 mph) mark on the speedometer, hold SET-.

 : Press to disengage ACC without erasing the selected set speed.

 : Press to select a following gap setting for ACC of Far, Medium, or Near.

The speedometer reading can be displayed in either English or metric units. See *Instrument Cluster* ⇨ 55. The increment value used depends on the units displayed.

Switching Between ACC and Regular Cruise Control



To switch between ACC and regular cruise control, press and hold . A Driver Information Display (DIC) message displays. See *Vehicle Messages* ⇨ 74.



ACC Indicator



Regular Cruise Control Indicator



When ACC is engaged, a green  indicator will be lit on the instrument cluster and the following gap will be displayed. When the regular cruise control is engaged, a green  indicator will be lit on the instrument cluster; the following gap will not display.

When the vehicle is turned on, the cruise control mode will be set to the last mode used before the vehicle was turned off.

Warning

Always check the cruise control indicator on the instrument cluster to determine which mode cruise control is in before using the feature. If ACC is not active, the vehicle will not automatically brake for other vehicles, which could cause a crash if the brakes are not applied manually. You and others could be seriously injured or killed.

Setting Adaptive Cruise Control

If  is on when not in use, SET-/RES+ could be pressed by mistake and engage ACC when not desired. Keep  off when cruise is not being used.

Select the set speed desired for ACC. This is the vehicle speed when no vehicle is detected in your path.

While the vehicle is moving, ACC will not set at a speed less than 5 km/h (3 mph), although the minimum allowable set speed is 15 mph.

To set ACC while moving:

1. Press .
2. Get up to the desired speed.
3. Press and release SET-.
4. Remove foot from the accelerator.

After ACC is set, it may immediately apply the brakes if a vehicle ahead is detected closer than the selected following gap.



ACC can also be set while the vehicle is stopped if ACC is on and the brake pedal is applied.

The ACC indicator displays on the instrument cluster. When ACC is turned on, the indicator will be lit white. When ACC is active, the indicator will turn green.

Be mindful of speed limits, surrounding traffic speeds, and weather conditions when selecting the set speed.

Resuming a Set Speed

If the ACC is set at a desired speed and then the brakes are applied, ACC is disengaged without erasing the set speed from memory.

To begin using ACC again, press RES+ up briefly.

- If the vehicle is moving more than 5 km/h (3 mph), it returns to the previous set speed.
- If the vehicle is stopped with the brake pedal applied, press RES+ and release the brake pedal. ACC will hold the vehicle until RES+ or the accelerator pedal is pressed.

A green ACC indicator and the set speed display on the instrument cluster. The vehicle ahead indicator may be flashing if a vehicle ahead was present and moved. See “Approaching and Following a Vehicle” later in this section.

Once ACC has resumed, if there is no vehicle ahead, if the vehicle ahead is beyond the selected following gap, or if the vehicle has exited a sharp curve, then the vehicle speed will increase to the set speed.

Increasing Speed While ACC Is at a Set Speed

If ACC is already activated, do one of the following:

- Use the accelerator to get to the higher speed. Press SET-. Release SET- and the accelerator pedal. The vehicle will now cruise at the higher speed.
When the accelerator pedal is pressed, ACC will not brake because it is overridden. The ACC indicator will turn blue on the instrument cluster.
- Press and hold RES+ until the desired set speed is displayed, then release it.
- To increase vehicle speed in smaller increments, press RES+ briefly. For each press, the vehicle goes about 1 km/h (1 mph) faster.
- To increase vehicle speed in larger increments, hold RES+. While holding RES+, the vehicle speed increases to the next 5 km/h (5 mph) step, then continues to increase by 5 km/h (5 mph) at a time.

The set speed can also be increased while the vehicle is stopped.

- If stopped with the brake applied, press or hold RES+ until the desired set speed is displayed.

- If ACC is holding the vehicle at a stop and there is another vehicle directly ahead, pressing RES+ will increase the set speed.
- Pressing RES+ when there is no longer a vehicle ahead or the vehicle ahead is pulling away and the brake is not applied will cause the ACC to resume.

When it is determined that there is no vehicle ahead or the vehicle ahead is beyond the selected following gap, then the vehicle speed will increase to the set speed.

Reducing Speed While ACC Is at a Set Speed

If ACC is already activated, do one of the following:

- Use the brake to get to the desired lower speed. Release the brake and press SET-. The vehicle will now cruise at the lower speed.
- Press and hold SET- until the desired lower speed is reached, then release it.
- To decrease the vehicle speed in smaller increments, press SET- briefly. For each press, the vehicle goes about 1 km/h (1 mph) slower.

- To decrease the vehicle speed in larger increments, hold SET-. While holding SET-, the vehicle speed decreases to the next 5 km/h (5 mph) step, then continues to decrease by 5 km/h (5 mph) at a time.

The set speed can also be decreased while the vehicle is stopped.

- If stopped with the brake applied, press or hold SET- until the desired set speed is displayed.

Selecting the Follow Distance Gap

When a slower moving vehicle is detected ahead within the selected following gap, ACC will adjust the vehicle's speed and attempt to maintain the follow distance gap selected.

Press  on the steering wheel to adjust the following gap. Each press cycles the gap button through three settings: Far, Medium, or Near.

When pressed, the current gap setting displays briefly on the instrument cluster. The gap setting will be maintained until it is changed.

Gap Adjust



Far Gap Setting

Gap Adjust



Medium Gap Setting

Gap Adjust





Near Gap Setting

Since each gap setting corresponds to a following time (Far, Medium, or Near), the following distance will vary based on vehicle speed. The faster the vehicle speed, the further back your vehicle will follow a vehicle detected ahead. Consider traffic and weather conditions when selecting the following gap. The range of selectable gaps may not be appropriate for all drivers and driving conditions.

Changing the gap setting automatically changes the alert timing sensitivity (Far, Medium, or Near) for the Forward Collision Alert (FCA) feature. See *Forward Collision Alert (FCA) System* ⇨ 151.

Courtesy Gap

Press and hold  on the steering wheel when vehicle is moving to temporarily increase the gap with the vehicle ahead to allow for merging traffic.

Press and hold  when stopped to cancel ACC from resuming automatically (if the stop is brief) and remain stationary. This can be used to allow traffic to merge between you and the vehicle ahead. Press RES+ or the accelerator pedal to resume ACC.

Following distance gap will return to the original selection after hold.

Alerting the Driver

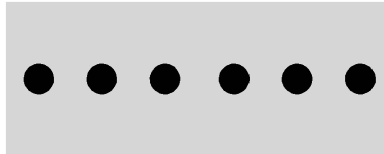

If ACC is engaged, driver action may be required when ACC cannot apply sufficient braking because of approaching a vehicle too rapidly.

When this condition occurs, the collision alert symbol will flash on the windshield. Either eight beeps will sound from the front, or both sides of the Safety Alert Seat (if equipped) will pulse five times. To view available settings from the infotainment screen, touch Settings > Vehicle > Collision/Detection Systems.

See *Defensive Driving* ⇨ 111.

Approaching and Following a Vehicle



The vehicle ahead indicator is in the instrument cluster. It only displays when a vehicle is detected in your vehicle's path moving in the same direction. If this symbol is not displaying, ACC will not respond to or brake for vehicles ahead.

ACC automatically slows the vehicle down and adjusts vehicle speed to follow a detected vehicle ahead at the selected following gap. The vehicle speed increases or decreases to follow a detected vehicle in front of your vehicle when that vehicle is

traveling slower than your vehicle set speed. It may apply limited braking, if necessary. When braking is active, the brake lamps will come on. The automatic braking may feel or sound different than if the brakes were applied manually. This is normal.

Passing a Vehicle While Using ACC

If the set speed is high enough, and the left turn signal is used to pass a vehicle ahead in the selected following gap, ACC may assist by gradually accelerating the vehicle prior to the lane change.

Warning

When using ACC to pass a vehicle or perform a lane change, the following distance to the vehicle being passed may be reduced. ACC may not apply sufficient acceleration or braking when passing a vehicle or performing a lane change. Always be ready to manually accelerate or brake to complete the pass or lane change.

Stationary or Very Slow-Moving Objects

Warning

ACC may not detect and react to stopped or slow-moving vehicles ahead of you. For example, the system may not brake for a vehicle it has never detected moving. This can occur in stop-and-go traffic or when a vehicle suddenly appears due to a vehicle ahead changing lanes. Your vehicle may not stop and could cause a crash. Use caution when using ACC. Your complete attention is always required while driving and you should be ready to take action and apply the brakes.

Irregular Objects Affecting ACC

ACC may have difficulty detecting the following objects:

- Vehicles in front of your vehicle that have a rear aspect that is low, small, or irregular
- An empty truck or trailer that has no cargo in the cargo bed
- Vehicles with cargo extending from the back end

- Non-standard shaped vehicles, such as vehicle transport, vehicles with a side car fitted, or horse carriages
- Vehicles that are low to the road surface
- Objects that are close to the front of your vehicle
- Vehicles on which extremely heavy cargo is loaded in the cargo area or rear seat

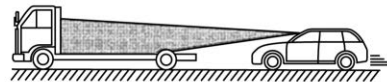

ACC Automatically Disengages

ACC may automatically disengage and the driver will need to manually apply the brakes to slow the vehicle if:

- The sensors are blocked.
- The Traction Control System (TCS) or StabiliTrak/ESC system has activated or been disabled.
- There is a fault in the system.
- A DIC message displays to indicate that ACC is temporarily unavailable.

- The radar falsely reports blockage when driving in a desert or remote area with no other vehicles or roadside objects.

The ACC indicator will turn white when ACC is no longer active.

In some cases, when ACC is temporarily unavailable, regular cruise control may be used. See “Switching Between ACC and Regular Cruise Control” in this section. Always consider driving conditions before using either cruise control system.

Notification to Resume ACC

ACC will maintain a follow gap behind a detected vehicle and slow your vehicle to a stop behind that vehicle.

If the stopped vehicle ahead has driven away and ACC has not resumed, the vehicle ahead indicator will flash as a reminder to check traffic ahead before proceeding. In addition, the left and right sides of the Safety Alert Seat (if equipped) will pulse three times, or three beeps will sound. To view available settings from the infotainment screen, touch Settings > Vehicle > Collision/Detection Systems > Alert Type > Adaptive Cruise Go Notifier.

When the vehicle ahead drives away, ACC resumes automatically if the stop was brief. If necessary, press RES+ or the accelerator pedal to resume ACC. If stopped for more than two minutes or if the driver door is opened and the driver seat belt is unbuckled, the ACC automatically applies the Electric Parking Brake (EPB) to hold the vehicle. The EPB status light will turn on. See *Electric Parking Brake* ⇨ 129. To release the EPB, press the accelerator pedal.

A DIC warning message may display indicating to shift to P (Park) before exiting the vehicle. See *Vehicle Messages* ⇨ 74.

Warning

If ACC has stopped the vehicle, and if ACC is disengaged, turned off, or canceled, the vehicle will no longer be held at a stop. The vehicle can move. When ACC is holding the vehicle at a stop, always be prepared to manually apply the brakes.

Warning

Leaving the vehicle without placing it in P (Park) can be dangerous. Do not leave the vehicle while it is being held at a stop by ACC. Always place the vehicle in P (Park) and turn off the ignition before leaving the vehicle.

ACC Override

If using the accelerator pedal while ACC is active, the ACC indicator turns blue on the instrument cluster indicating ACC braking will not occur. ACC will resume operation when the accelerator pedal is not being pressed.

Warning

The ACC will not automatically apply the brakes if your foot is resting on the accelerator pedal. You could crash into a vehicle ahead of you.

Curves in the Road

Warning

On curves, ACC may not detect a vehicle ahead in your lane. You could be startled if the vehicle accelerates up to the set speed, especially when following a vehicle exiting or entering exit ramps. You could lose control of the vehicle or crash. Do not use ACC while driving on an entrance or exit ramp. Always be ready to use the brakes if necessary.

Warning

On curves, ACC may respond to a vehicle in another lane, or may not have time to react to a vehicle in your lane. You could crash into a vehicle ahead of you, or lose control of your vehicle. Give extra attention in curves and be ready to use the brakes if necessary. Select an appropriate speed while driving in curves.

ACC may operate differently in a sharp curve. It may reduce the vehicle speed if the curve is too sharp.

ACC automatically slows the vehicle down while navigating the curve and may increase speed out of the curve, but will not exceed the set speed.

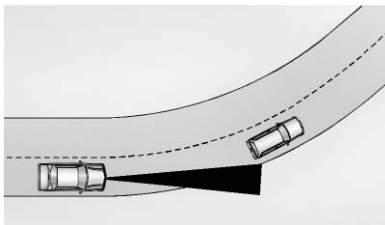

When following a vehicle and entering a curve, ACC may not detect the vehicle ahead and accelerate to the set speed. When this happens, the vehicle ahead indicator will not appear.

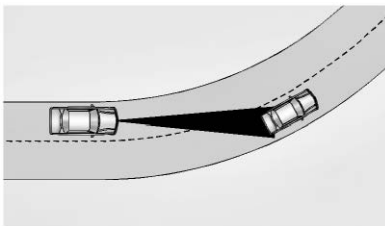

ACC may detect a vehicle that is not in your lane and apply the brakes.

ACC may occasionally provide an alert and/or braking that is considered unnecessary. It could respond to vehicles in different lanes or stationary objects when entering or exiting a curve. This is normal operation. The vehicle does not need service.

Other Vehicle Lane Changes

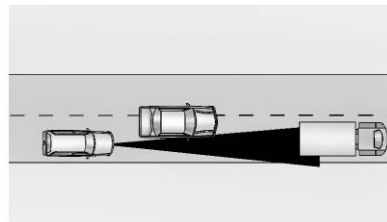

ACC will not detect a vehicle ahead until it is completely in the lane. The brakes may need to be manually applied.

Objects Not Directly in Front of Your Vehicle

The detection of objects in front of the vehicle may not be possible if:

- The vehicle or object ahead is not within your lane.
- The vehicle ahead is shifted, not centered, or is shifted to one side of the lane.

Driving in Narrow Lanes

Vehicles in adjacent traffic lanes or roadside objects may be incorrectly detected when located along the roadway.

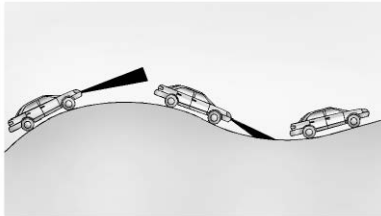

Do Not Use ACC on Hills and When Towing a Trailer



Do not use ACC when driving on steep hills or when towing a trailer. ACC will not detect a vehicle in the lane while driving on steep hills. If the brakes are applied, ACC disengages.

Disengaging ACC

There are three ways to disengage ACC:

- Step lightly on the brake pedal.
- Press .
- Press .

Erasing Speed Memory

The ACC set speed is erased from memory if  is pressed or if the ignition is turned off.

Weather Conditions Affecting ACC

If the interior temperature is extremely high, the instrument cluster may indicate that ACC is temporarily unavailable. This can be caused by extreme hot weather conditions with direct sunlight on the front camera. ACC will return to normal operation once the cabin temperature is lower.

Conditions that are associated with low visibility, such as fog, rain, snow, or road spray, may limit ACC performance. Water droplets from rain or snow that remain on the windshield may also limit ACC's ability to detect objects.

Warning

Camera visibility may be limited and the ACC system may not work properly if the windshield is not clear. Do not use ACC if moisture is present on the inside of the windshield or the windshield washer is used in cold weather. Turn on the front defroster and make sure the windshield is
(Continued)

Warning (Continued)

clear before using ACC. Before driving, check that the windshield wipers are in good condition and replace them if worn.

Lighting Conditions Affecting ACC

The ACC front camera can be affected by poor lighting conditions, and ACC may have limited performance when:

- There are changes in brightness, such as entering and exiting tunnels, bridges, and overpasses.
- Low sun angles cause the camera to not detect objects, or it is more difficult to detect objects in the same traffic lane.
- Lighting is poor in the evening or early morning
- There are multiple changes in brightness or shadows along the vehicle roadway.
- In a tunnel without the headlamps on, or in a tunnel when there is a vehicle in front that does not have its taillamps on.
- Subjected to strong light from opposing lane traffic in the front of the vehicle, such as high-beam headlamps from oncoming traffic.

Accessory Installations and Vehicle Modifications

Do not install or place any object around the front camera windshield area that would obstruct the front camera view.

Do not install objects on top of the vehicle that overhang and obstruct the front camera, such as a canoe, kayak, or other items that can be transported on a roof rack system.

Do not modify the hood, headlamps, or fog lamps, as this may limit the camera's ability to detect an object.

Cleaning the Sensing System

The camera sensor on the windshield behind the rearview mirror can become blocked by snow, ice, dirt, mud, or debris. This area needs to be cleaned for ACC to operate properly.

The vehicle headlamps may need to be cleaned due to dirt, snow, or ice. Objects that are not illuminated correctly may be difficult to detect.

If ACC will not operate, regular cruise control may be available. See "Switching Between ACC and Regular Cruise Control" in this section. Always consider driving conditions before using either cruise control system.

For cleaning instructions, see "Washing the Vehicle" under *Exterior Care* ⇨ 219.

Driver Assistance Systems

This vehicle may have features that work together to help avoid crashes or reduce crash damage while driving, backing, and parking. Read this entire section before using these systems.

Warning

Do not rely on the Driver Assistance Systems. These systems do not replace the need for paying attention and driving safely. You may not hear or feel alerts or warnings provided by these systems. Failure to use proper care when driving may result in injury, death, or vehicle damage. See *Defensive Driving* ⇨ 111.

(Continued)

Warning (Continued)

Under many conditions, these systems will not:

- Detect children, pedestrians, bicyclists, or animals.
- Detect vehicles or objects outside the area monitored by the system.
- Work at all driving speeds.
- Warn you or provide you with enough time to avoid a crash.
- Work under poor visibility or bad weather conditions.
- Work if the detection sensor is not cleaned or is covered by ice, snow, mud, or dirt.
- Work if the detection sensor is covered up, such as with a sticker, magnet, or metal plate.
- Work if the area surrounding the detection sensor is damaged or not properly repaired.

(Continued)

Warning (Continued)

Complete attention is always required while driving, and you should be ready to take action and apply the brakes and/or steer the vehicle to avoid crashes.

Audible or Safety Alert Seat

Some driver assistance features alert the driver of obstacles by beeping. To view available settings from the infotainment screen, touch Settings > Vehicle > Comfort and Convenience.

With the Safety Alert Seat, the driver seat cushion may provide a vibrating pulse alert instead of beeping. To view available settings from the infotainment screen, touch Settings > Vehicle > Collision/Detection Systems.

Cleaning

Depending on vehicle options, keep these areas of the vehicle clean to ensure the best driver assistance feature performance. Driver Information Center (DIC) messages may display when the systems are unavailable or blocked.

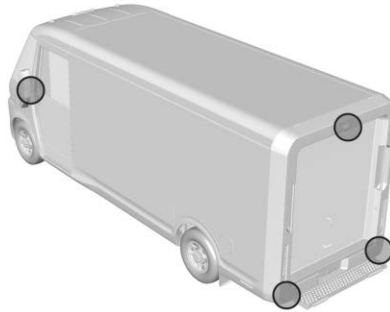

- Front and rear bumpers and the area below the bumpers
- Front grille and headlamps
- Front camera lens in the front grille or near the front emblem

- Front side and rear side panels
- Outside of the windshield in front of the rearview mirror
- Side camera lens on the bottom of the outside mirrors
- Rear side corner bumpers
- Rear Vision Camera in the tailgate handle
- Rear Camera Mirror and Cargo View Camera in the Center High-Mounted Stoplamp

Radio Frequency

This vehicle may be equipped with driver assistance systems that operate using radio frequency. See *Radio Frequency Statement* ⇨ 237.

Rear Vision Camera (RVC)

When the vehicle is shifted into R (Reverse), the Rear Vision Camera (RVC) displays an image of the area behind the vehicle in the infotainment display. The previous screen displays when the vehicle is shifted out of R (Reverse) after a short delay. To return to the previous screen sooner, press Home or Back on the infotainment system, shift into P (Park), or reach a vehicle speed of approximately 12 km/h (8 mph) while in D (Drive).

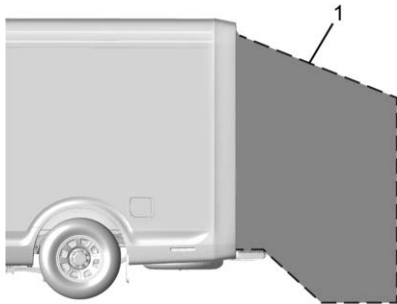

1. View Displayed by the Camera

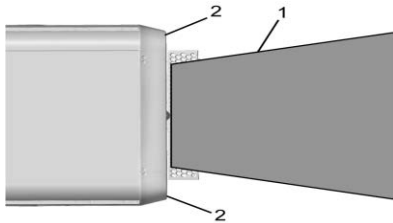

1. View Displayed by the Camera
2. Corners of the Rear Bumper

Displayed images may be farther or closer than they appear. The area displayed is limited and objects that are close to either corner of the bumper or under the bumper do not display.

A warning triangle may appear on the infotainment display to show that Rear Park Assist (RPA) or Rear Cross Traffic Alert (RCTA) has detected an object. This triangle changes from amber to red and increases in size the closer the object.

⚠ Warning

The camera(s) do not display children, pedestrians, bicyclists, crossing traffic, animals, or any other object outside of the cameras' field of view, below the bumper, or under the vehicle. Shown distances may be different from actual distances. Do not drive or park the vehicle using only these camera(s). Always check behind and around the vehicle before driving. Failure to use proper care may result in injury, death, or vehicle damage.

Surround Vision System

If equipped, Surround Vision shows an image of the area surrounding the vehicle, along with the front or rear camera views on the infotainment display. The front camera is in the grille or near the front emblem, the side cameras are on the bottom of the outside mirrors, and the rear camera is above the license plate.

The Surround Vision system can be accessed by selecting CAMERA in the infotainment display, pressing the camera button on the center stack, or when the vehicle is shifted into R (Reverse). To return to the previous screen sooner, when not in R (Reverse) press Home or Back on the infotainment system, shift into P (Park), or reach a vehicle speed of approximately 12 km/h (8 mph) while in D (Drive).

⚠ Warning

The Surround Vision cameras have blind spots and will not display all objects near the corners of the vehicle. Folding outside mirrors that are out of position may not display surround view correctly. Always check around the vehicle when parking or backing.

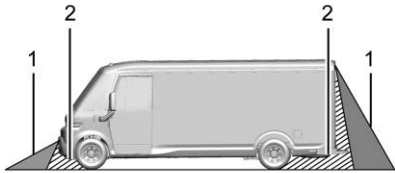

1. Views Displayed by the Surround Vision Cameras
2. Area Not Shown

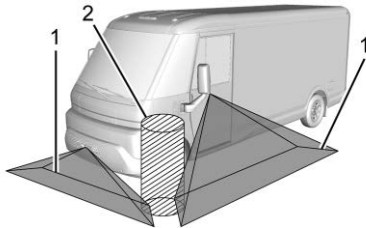

1. Views Displayed by the Surround Vision Cameras
2. Area Not Shown

Warning

The camera(s) do not display children, pedestrians, bicyclists, crossing traffic, animals, or any other object outside of the cameras' field of view, below the bumper, or under the vehicle. Shown distances may be different from actual distances. Do not drive or park the vehicle using only these camera(s). Always check behind and around the vehicle before driving. Failure to use proper care may result in injury, death, or vehicle damage.

Camera Views

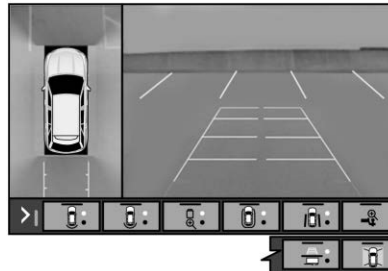

Touch the camera view buttons along the bottom of the infotainment display. Available views will differ depending on vehicle options.

Front/Rear Standard View : Displays an image of the area in front or behind the vehicle. Touch Front/Rear Standard View on the infotainment display when a camera view is active. Touching the button multiple times will toggle between front and rear camera views.

If equipped, the front view camera also displays when the Park Assist system detects an object within 30 cm (12 in).

Front/Rear Overhead View : Displays a Front or Rear Overhead View of the vehicle. Touching the button will toggle between the two views.

Side Forward/Rearward View : Displays a view that shows objects next to the front or rear sides of the vehicle. Touch Side Forward/Rearward View on the infotainment display when a camera view is active. Touching the button multiple times will toggle between forward and rearward views. Park Assist and RCTA overlays are not available when Side Forward/Rearward View is active.

Hitch View : Assists while connecting to a trailer. Displays a zoomed-in view of the hitch to help align the vehicle's hitch ball with the trailer coupler. Shifting into P (Park) while in this view will automatically engage the Electric Parking Brake (EPB).

Guidance Lines : Displays available guidelines. The horizontal markings represent distance from the vehicle.

Top Down View : Displays an image of the area surrounding the vehicle, along with other views in the infotainment display. Top Down can be enabled or disabled by touching the Top Down View button multiple times.

Hitch Guidance

If equipped, this feature displays a single, centered guideline on the camera display to assist with aligning a vehicle's hitch ball with a trailer coupler. Select the trailer guidance line button, then align the trailer guidance line over the trailer coupler. Continuously steer the vehicle to keep the guidance line centered on the coupler when backing. RVC Park Assist overlays will not display when the trailer guidance line is active. Hitch Guidance is only available in Standard View.

To check the trailer when in a forward gear above 12 km/h (8 mph), touch CAMERA on the infotainment display to view the rear camera. Touch X to exit the view or it will be removed automatically after eight seconds.

Warning

Use Hitch Guidance only to help back the vehicle to a trailer hitch or, when traveling above 12 km/h (8 mph), to briefly check the status of your trailer. Do not use for any other purpose, such as making lane change decisions. Before making a lane change, always check the mirrors and glance over your shoulder. Improper use could result in serious injury to you or others.

Park Assist

With Front and Rear Park Assist (FPA and RPA), as the vehicle moves at speeds of less than 8 km/h (5 mph) the sensors on the bumpers may detect objects up to 1.2 m (4 ft) in front and 2.5 m (8 ft) behind the vehicle within a zone 25 cm (10 in) high off the ground and below bumper level. These detection distances may be shorter during warmer or humid weather. Blocked sensors

will not detect objects and can also cause false detections. Keep the sensors clean of mud, dirt, snow, ice, and slush; and clean sensors after a car wash in freezing temperatures.

Warning

The Park Assist system does not detect children, pedestrians, bicyclists, animals, or objects located below the bumper or that are too close or too far from the vehicle. It is not available at speeds greater than 8 km/h (5 mph). To prevent injury, death, or vehicle damage, even with Park Assist, always check the area around the vehicle and check all mirrors before moving forward or backing.

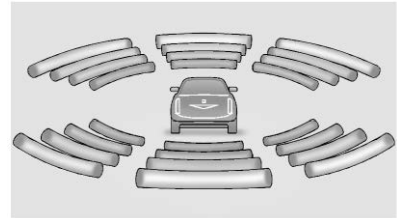

The instrument cluster may have a Park Assist display with bars that show “distance to object” and object location information for the Front and Rear Park Assist system. As the object gets closer, more bars light up and the bars change color from yellow to amber to red.

When an object is first detected in the rear, one beep will be heard from the rear, or both sides of the Safety Alert Seat will pulse two times. When an object is very close — <0.4 m (1.5 ft) in the vehicle rear or <0.3 m (1 ft) in the vehicle front — a continuous beep will sound from the rear or front depending on object location, or both sides of the Safety Alert Seat will pulse five times. Beeps for FPA are higher pitched than for RPA.

Turning the Features On or Off



Press  on the instrument panel, to the left of the steering wheel, to turn on or off the Front and Rear Park Assist. The indicator

light next to the button comes on when the features are on and turns off when the features have been disabled.

Front and Rear Park Assist can be turned Off, On, or On with Towbar. To view available settings from the infotainment screen, touch Settings > Vehicle > Collision/Detection Systems. If Park Assist is turned off through vehicle personalization, the Park Assist button will be disabled. To turn Park Assist on again, select On in vehicle personalization. The On with Towbar setting allows Park Assist to work properly with a trailer hitch. Some larger trailer hitches may not be compatible.

Turn off Park Assist when towing a trailer.

RPA symbols can be turned on or off. To view available settings from the infotainment screen, touch Settings > Vehicle > Collision/Detection Systems > Rear Camera Park Assist Symbols.

Reverse Automatic Braking (RAB)

Backing Warning and Reverse Automatic Braking (RAB)

When in R (Reverse), Backing Warning alerts of rear objects at vehicle speeds greater than 8 km/h (5 mph), and RAB may automatically brake hard at speeds between 1–32 km/h (0.5–20 mph).

The Backing Warning System will beep once from the rear when an object is first detected, or pulse twice on both sides of the Safety Alert Seat. When the system detects a potential crash, beeps will be heard from the rear, or five pulses will be felt on both sides of the Safety Alert Seat. There may also be a brief, sharp application of the brakes.

Warning

The Backing Warning System only operates at speeds greater than 8 km/h (5 mph). It does not detect children, pedestrians, bicyclists, animals, or objects below the bumper or that are too close or too far from the vehicle. In some situations, such as at higher backing

(Continued)

Warning (Continued)

speeds, there may not be enough time for the short, sharp application of the vehicle brake system to occur. To prevent injury, death, or vehicle damage, even with the Backing Warning System, always check the area around the vehicle and check all mirrors before backing.

When the vehicle is in R (Reverse), if the system detects the vehicle is backing too fast to avoid a crash with a detected object behind your vehicle in your path, it may automatically brake hard to a stop to help avoid or reduce the harm caused by a backing crash.

 **Warning**

RAB may not avoid many types of backing crashes. Do not wait for the automatic braking to apply. This system is not designed to replace driver braking and only works in R (Reverse) when an object is detected directly behind the vehicle. It may not brake or stop in time to avoid a crash. It will not brake for objects when the vehicle is moving at

(Continued)

Warning (Continued)

very low speeds. It does not detect children, pedestrians, bicyclists, animals, or objects below the bumper or that are too close or too far from the vehicle. To prevent injury, death, or vehicle damage, even with RAB, always check the area around the vehicle before and while backing.

Pressing the brake pedal after the vehicle comes to a stop will release RAB. If the brake pedal is not pressed soon after the stop, the Electric Parking Brake (EPB) may be set. When it is safe, press the accelerator pedal firmly at any time to override RAB.

 **Warning**

There may be instances where unexpected or undesired automatic braking occurs. If this happens, either press the brake pedal or firmly press the accelerator pedal to release the brakes from the RAB system. Before releasing the brakes, check the RVC and check the area around the vehicle to make sure it is safe to proceed.

Unexpected braking events are possible with a static installed accessory, such as a bike rack or hitch-mounted cargo carrier.

Rear Cross Traffic Alert (RCTA) System

If equipped, when the vehicle is shifted into R (Reverse), RCTA shows a red warning triangle with a left or right pointing arrow on the infotainment display to warn of traffic coming from the left or right. This system detects objects coming from up to 20 m (65 ft) from the left or right side of the vehicle. When an object is detected, either three beeps sound from the left or right or three Safety Alert Seat pulses occur on the left or right side, depending on the direction of the detected vehicle.

Rear Cross Traffic Braking (RCTB)

If equipped, RCTB displays a red warning triangle with a left or right pointing arrow on the infotainment screen to warn of traffic coming from the left or right. The system detects objects coming from up to 20 m (65 ft) from the left or right side of the vehicle. When an object is detected, three beeps sounds from the left or right,

depending on the direction of the detected vehicle. RCTB will bring the vehicle to a full stop if a collision is imminent.

Driving With a Trailer

Use caution while backing up when towing a trailer. RCTA and RCTB are automatically disabled when a trailer is attached to the vehicle.

Turning the Feature On or Off

To view available settings from the infotainment screen, touch Settings > Vehicle > Collision/Detection Systems.

Assistance Systems for Driving

If equipped, when driving the vehicle in a forward gear, Forward Collision Alert (FCA), Lane Departure Warning (LDW), Lane Keep Assist (LKA), Blind Zone Steering Assist (BZSA), Lane Change Alert (LCA), Automatic Emergency Braking (AEB), and/or the Front Pedestrian Braking (FPB) System can help to avoid a crash or reduce crash damage.

Forward Collision Alert (FCA) System

If equipped, the FCA system may help to avoid or reduce the harm caused by front-end crashes. When approaching a

vehicle ahead too quickly, FCA provides a red flashing alert on the windshield and rapidly beeps or pulses the driver seat. FCA also lights an amber visual alert if following another vehicle much too closely.

FCA detects vehicles within a distance of approximately 60 m (197 ft) and operates at speeds above 8 km/h (5 mph). If the vehicle has Adaptive Cruise Control (ACC), it can detect vehicles to distances of approximately 110 m (360 ft) and operates at all speeds. See *Adaptive Cruise Control* ⇨ 134.

Warning

FCA is a warning system and does not apply the brakes. When approaching a slower-moving or stopped vehicle ahead too rapidly, or when following a vehicle too closely, FCA may not provide a warning with enough time to help avoid a crash. It also may not provide any warning at all. FCA does not warn of pedestrians, animals, signs, guardrails, bridges, construction barrels, or other objects. Be ready to take action and apply the brakes. See *Defensive Driving* ⇨ 111.

FCA can be disabled through vehicle personalization. To view available settings from the infotainment screen, touch Settings > Vehicle > Collision/Detection Systems.

Detecting the Vehicle Ahead



FCA warnings will not occur unless the FCA system detects a vehicle ahead. When a vehicle is detected, the vehicle ahead indicator will display green. Vehicles may not be detected on curves, highway exit ramps, or hills, due to poor visibility; or if a vehicle ahead is partially blocked by pedestrians or other objects. FCA will not detect another vehicle ahead until it is completely in the driving lane.

Warning

FCA does not provide a warning to help avoid a crash, unless it detects a vehicle. FCA may not detect a vehicle ahead if

(Continued)

Warning (Continued)

the FCA sensor is blocked by dirt, snow, or ice, or if the windshield is damaged. It may also not detect a vehicle on winding or hilly roads, or in conditions that can limit visibility such as fog, rain, or snow, or if the headlamps or windshield are not cleaned or in proper condition. Keep the windshield, headlamps, and FCA sensors clean and in good repair.

Collision Alert

When your vehicle approaches another detected vehicle too rapidly, the red FCA display will flash on the windshield. Also, eight rapid high-pitched beeps will sound from the front, or both sides of the Safety Alert Seat will pulse five times. When this Collision Alert occurs, the brake system may prepare for driver braking to occur more

rapidly which can cause a brief, mild deceleration. Continue to apply the brake pedal as needed.

Tailgating Alert

The vehicle ahead indicator will display amber when you are following a vehicle ahead much too closely.

Selecting the Alert Timing

The Collision Alert control is on the steering wheel. Press  to set the FCA timing to Far, Medium, or Near. The first button press shows the current setting on the DIC. Additional button presses will change this setting. The chosen setting will remain until it is changed and will affect the timing of both the Collision Alert and the Tailgating Alert features. The timing of both alerts will vary based on vehicle speed. The faster the vehicle speed, the farther away the alert will occur. Consider traffic and weather conditions when selecting the alert timing.

The range of selectable alert timings may not be appropriate for all drivers and driving conditions.

If your vehicle is equipped with Adaptive Cruise Control (ACC), changing the FCA timing setting automatically changes the following gap setting (Far, Medium, or Near).

Following Distance Indicator

The following distance to a moving vehicle ahead in your path is indicated in following time in seconds on the Driver Information Center (DIC). The minimum following time is 0.5 seconds away. If there is no vehicle detected ahead, or the vehicle ahead is out of sensor range, dashes will be displayed.

Unnecessary Alerts

FCA may provide unnecessary alerts for turning vehicles, vehicles in other lanes, objects that are not vehicles, or shadows. These alerts are normal operation and the vehicle does not need service.

Cleaning the System

If the FCA system does not seem to operate properly, this may correct the issue:

- Clean the outside of the windshield in front of the rearview mirror.
- Clean the entire front of the vehicle.
- Clean the headlamps.

Automatic Emergency Braking (AEB)

The AEB system may help avoid or reduce the harm caused by front-end crashes. AEB also includes Intelligent Brake Assist (IBA). When the system detects a vehicle ahead in your path that is traveling in the same direction that you may be about to crash into, it can provide a boost to braking or automatically brake the vehicle. This can help avoid or lessen the severity of crashes when driving in a forward gear. Depending on the situation, the vehicle may automatically brake moderately or hard. Always wear a seatbelt and ensure that all passengers are properly restrained. This automatic emergency braking can only occur if a vehicle is detected. This is shown by the FCA vehicle ahead indicator being lit. See *Forward Collision Alert (FCA) System* ⇨ 151.

The system works when driving in a forward gear between 8 km/h (5 mph) and 135 km/h (84 mph), or on vehicles with Adaptive Cruise Control (ACC), above 4 km/h (2 mph). It can detect vehicles up to approximately 60 m (197 ft).

Warning

AEB is an emergency crash preparation feature and is not designed to avoid crashes. Do not rely on AEB to brake the vehicle. AEB will not brake outside of its operating speed range and only responds to detected vehicles.

AEB may not:

- Detect a vehicle ahead on winding or hilly roads.
- Detect all vehicles, especially vehicles with a trailer, tractors, muddy vehicles, etc.
- Detect a vehicle when weather limits visibility, such as in fog, rain, or snow.
- Detect a vehicle ahead if it is partially blocked by pedestrians or other objects.

(Continued)

Warning (Continued)

Complete attention is always required while driving, and you should be ready to take action and apply the brakes and/or steer the vehicle to avoid crashes.

AEB may slow the vehicle to a complete stop to try to avoid a potential crash. If this happens, AEB may engage the Electric Parking Brake (EPB) to hold the vehicle at a stop. Release the EPB or firmly press the accelerator pedal.

Warning

AEB may automatically brake the vehicle suddenly in situations where it is unexpected and undesired. It could respond to a turning vehicle ahead, guardrails, signs, and other non-moving objects. To override AEB, firmly press the accelerator pedal, if it is safe to do so.

Intelligent Brake Assist (IBA)

IBA may activate when the brake pedal is applied quickly by providing a boost to braking based on the speed of approach and distance to a vehicle ahead.

Minor brake pedal pulsations or pedal movement during this time is normal and the brake pedal should continue to be applied as needed. IBA will automatically disengage only when the brake pedal is released.

Warning

IBA may increase vehicle braking in situations when it may not be necessary. You could block the flow of traffic. If this occurs, take your foot off the brake pedal and then apply the brakes as needed.

AEB and IBA can be disabled. To view available settings from the infotainment screen, touch Settings > Vehicle > Collision/Detection Systems.

Warning

Using AEB or IBA while towing a trailer could cause you to lose control of the vehicle and crash. Turn the system to Alert or Off when towing a trailer.

A system unavailable message may display if:

- The front of the vehicle or windshield is not clean.

- Heavy rain or snow is interfering with object detection.
- There is a problem with the StabiliTrak/Electronic Stability Control (ESC) system.

The AEB system does not need service.

Front Pedestrian Braking (FPB) System

If equipped, the FPB system may help avoid or reduce the harm caused by front-end crashes with nearby pedestrians when driving in a forward gear. FPB displays an amber indicator, , when a nearby pedestrian is detected ahead. When approaching a detected pedestrian too quickly, FPB provides a red flashing alert on the windshield and rapidly beeps or pulses the driver seat. FPB can provide a boost to braking or automatically brake the vehicle. Always wear a seatbelt and ensure that all passengers are properly restrained. This system includes Intelligent Brake Assist (IBA), and the Automatic Emergency Braking (AEB) system may also respond to pedestrians. See *Automatic Emergency Braking (AEB)* ⇨ 153.

The FPB system can detect and alert to pedestrians in a forward gear at speeds between 8 km/h (5 mph) and 80 km/h (50 mph). During daytime driving, the system detects pedestrians up to a distance of approximately 40 m (131 ft). During nighttime driving, system performance is very limited.

Warning

FPB does not provide an alert or automatically brake the vehicle, unless it detects a pedestrian. FPB may not detect pedestrians, including children:

- When the pedestrian is not directly ahead, fully visible, or standing upright, or when part of a group.
- Due to poor visibility, including nighttime conditions, fog, rain, or snow.
- If the FPB sensor is blocked by dirt, snow, or ice.
- If the headlamps or windshield are not cleaned or in proper condition.

(Continued)

Warning (Continued)

Be ready to take action and apply the brakes. For more information, see *Defensive Driving* ⇨ 111. Keep the windshield, headlamps, and FPB sensor clean and in good repair.

FPB can be set to Off, Alert, or Alert and Brake through vehicle personalization. To view available settings from the infotainment screen, touch Settings > Vehicle > Collision/Detection Systems.

Detecting the Pedestrian Ahead

FPB alerts and automatic braking will not occur unless the FPB system detects a pedestrian. When a pedestrian that may enter the vehicle's forward path is detected in front of the vehicle, the pedestrian ahead indicator will display amber.

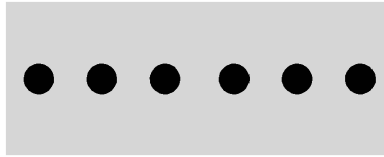
Front Pedestrian Alert

When the vehicle approaches a pedestrian ahead too rapidly, the red FPB alert display will flash on the windshield. Eight rapid high-pitched beeps will sound from the front, or both sides of the Safety Alert Seat will pulse five times. When this Pedestrian Alert occurs, the brake system may prepare for driver braking to occur more rapidly which can cause a brief, mild deceleration. Continue to apply the brake pedal as needed. Cruise control may be disengaged when the Front Pedestrian Alert occurs.

Automatic Braking

If FPB detects it is about to crash into a pedestrian directly ahead, and the brakes have not been applied, FPB may automatically brake moderately or brake hard. This can help to avoid some very low speed pedestrian crashes or reduce pedestrian injury. FPB can automatically brake to detected pedestrians between

8 km/h (5 mph) and 80 km/h (50 mph). Automatic braking levels may be reduced under certain conditions, such as higher speeds.

FPB may slow the vehicle to a complete stop to try and avoid a potential collision with a pedestrian. If this happens, Automatic Braking may engage the Electric Parking Brake (EPB) to hold the vehicle at a stop. Release the EPB. A firm press of the accelerator pedal will also release Automatic Braking and the EPB.

Warning

FPB may alert or automatically brake the vehicle suddenly in situations where it is unexpected and undesired. It could falsely alert or brake for objects similar in shape or size to pedestrians, including shadows. This is normal operation and the vehicle does not need service. To override Automatic Braking, firmly press the accelerator pedal, if it is safe to do so.

Automatic Braking can be disabled through vehicle personalization. To view available settings from the infotainment screen, touch Settings > Vehicle > Collision/Detection Systems > Front Pedestrian Detection.

Warning

Using the Front Pedestrian Braking system while towing a trailer could cause you to lose control of the vehicle and crash. Turn the system to Alert or Off when towing a trailer.

Cleaning the System

If FPB does not seem to operate properly, cleaning the outside of the windshield in front of the rearview mirror may correct the issue.

Side Blind Zone Alert (SBZA)

If equipped, the SBZA system is a lane-changing aid that assists drivers with avoiding crashes that occur with moving vehicles in the side blind zone, or blind spot areas. When the vehicle is in a forward gear, the left or right side mirror display will light up if a moving vehicle is detected in that blind zone. If the turn signal is activated and a vehicle is also detected on the same side, the display will flash as an extra warning not to change lanes. Since this system is part of the Lane Change Alert (LCA) system, read the entire LCA section before using this feature.

Lane Change Alert (LCA)

If equipped, the LCA system is a lane-changing aid that assists drivers with avoiding lane change crashes that occur with moving vehicles in the side blind zone (or spot) areas or with vehicles rapidly approaching these areas from behind. The LCA warning display will light up in the corresponding outside side mirror and will flash if the turn signal is on.

Warning

LCA does not alert the driver to vehicles outside of the system detection zones, pedestrians, bicyclists, or animals. It may not provide alerts when changing lanes under all driving conditions. Failure to use proper care when changing lanes may result in injury, death, or vehicle damage. Before making a lane change, always check mirrors, glance over your shoulder, and use the turn signals.

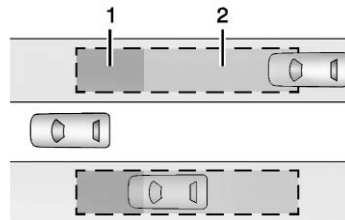
LCA Detection Zones

1. SBZA Detection Zone
2. LCA Detection Zone

The LCA sensor covers a zone of approximately one lane over from both sides of the vehicle, or 3.5 m (11 ft). The height of the zone is approximately between 0.5 m (1.5 ft) and 2 m (6 ft) off the ground. The Side Blind Zone Alert (SBZA) warning area starts at approximately the middle of the vehicle and goes back 5 m (16 ft). Drivers are also warned of vehicles rapidly approaching from up to 30 m (98 ft) behind the vehicle.

How the System Works

The LCA symbol lights up in the side mirrors when the system detects a moving vehicle in the next lane over that is in the side

blind zone or rapidly approaching that zone from behind. A lit LCA symbol indicates it may be unsafe to change lanes. Before making a lane change, check the LCA display, check mirrors, glance over your shoulder, and use the turn signals.



**Left Side Mirror
Display**



**Right Side Mirror
Display**

When the vehicle is started, both outside mirror LCA displays will briefly come on to indicate the system is operating. When the vehicle is in a forward gear, the left or right side mirror display will light up if a moving vehicle is detected in the next lane over in that blind zone or rapidly approaching that zone. If the turn signal is activated in the same direction as a detected vehicle, this display will flash as an extra warning not to change lanes.

LCA can be disabled through vehicle personalization. When you disable LCA, SBZA is also disabled. To view available settings

from the infotainment screen, touch Settings > Vehicle > Collision/Detection Systems. If LCA is disabled by the driver, the LCA mirror displays will not light up.

When the System Does Not Seem to Work Properly

The LCA system requires some driving for the system to calibrate to maximum performance. This calibration may occur more quickly if the vehicle is driving on a straight highway road with traffic and roadside objects (e.g., guardrails, barriers). During a trip, the LCA system is not operational until the vehicle first reaches a speed of 24 km/h (15 mph).

LCA displays may not come on when passing a vehicle quickly, for a stopped vehicle, or when towing a trailer. The LCA detection zones that extend back from the side of the vehicle do not move further back when a trailer is towed. Use caution while changing lanes when towing a trailer. LCA may alert to objects attached to the vehicle, such as a trailer, bicycle, or object extending out to either side of the vehicle. Attached objects may also interfere with the detection of vehicles. This is normal system operation; the vehicle does not need service.

LCA may not always alert the driver to vehicles in the next lane over, especially in wet conditions or when driving on sharp curves. The system does not need to be serviced. The system may light up due to guardrails, signs, trees, shrubs, and other non-moving objects. This is normal system operation; the vehicle does not need service.

LCA may not operate when the LCA sensors in the left or right corners of the rear bumper are covered with mud, dirt, snow, ice, or slush, or in heavy rainstorms. For cleaning instructions, see "Washing the Vehicle" under *Exterior Care* ⇨ 219. If the DIC still displays the system unavailable message after cleaning both sides of the vehicle toward the rear corners of the vehicle, see your dealer.

If the LCA displays do not light up when moving vehicles are in the side blind zone or are rapidly approaching this zone and the system is clean, the system may need service. Take the vehicle to your dealer.

Radio Frequency Information



See *Radio Frequency Statement* ⇨ 237.

Blind Zone Steering Assist (BZSA)

If equipped, the Blind Zone Steering Assist (BZSA) system can detect a potential crash with a moving vehicle in the lane you are entering. It provides a brief, urgent turn of the steering wheel to alert you to take action to avoid a collision.

BZSA works with the Lane Keep Assist (LKA). BZSA operates when the vehicle is in a forward gear, and only when LKA is enabled and able to assist. See *Lane Keep Assist (LKA)* ⇨ 158.

BZSA will provide a steering correction when your vehicle is about to leave the current lane of travel, with the possibility of a collision with a vehicle in the adjacent lane. This steering correction happens closer to the center of the lane and has a stronger steering correction than LKA. Unlike LKA, the steering correction with BZSA will happen even if your turn signal is on in the direction of lane departure.

In addition to the BZSA steering intervention, the  will turn amber, six beeps or six seat pulses will occur, if equipped with Safety Alert Seat, and  or  will flash on the outside rear view mirror.

Warning

Do not rely on Blind Zone Steering Assist (BZSA) to prevent crashes. This system does not replace the need to pay attention and drive safely. Failure to use proper care when driving may result in vehicle damage, injury, or death.

- BZSA performance may be affected by weather and road conditions.
- BZSA does not provide steering assistance to avoid a vehicle that is in, or has entered, your lane of travel.
- BZSA will not prevent a towed trailer from crossing into the adjacent lane. Always monitor the trailer position while towing to ensure it is in the same lane as your vehicle. BZSA is only designed to detect when your vehicle unintentionally crosses detected lane lines.

Lane Keep Assist (LKA)

If equipped, LKA may help avoid crashes due to unintentional lane departures. This system uses a camera to detect lane markings. The LKA system can be ready to assist at speeds between approximately

60 km/h (37 mph) and 180 km/h (112 mph). On some vehicles, the system will instead operate above 50 km/h (31 mph). LKA may assist by gently turning the steering wheel if the vehicle approaches a detected lane marking. It may also provide a Lane Departure Warning (LDW) alert, if the vehicle unintentionally crosses a detected lane marking. The LKA system is not intended to keep the vehicle centered in the lane. LKA will not assist or alert if the turn signal is active, or if it detects that you are accelerating, braking, or actively steering. LKA can be overridden by turning the steering wheel. If the system detects you are steering intentionally across a lane marker, the LDW may not be given. Do not expect the LDW to occur when you are intentionally crossing the lane marker.

Warning

The LKA system does not continuously steer the vehicle. It may not keep the vehicle in the lane or give a Lane Departure Warning (LDW) alert, even if a lane marking is detected.

(Continued)

Warning (Continued)

The LKA and LDW systems may not:

- Provide an alert or enough steering assist to avoid a lane departure or crash.
- Detect lane markings under poor weather or visibility conditions. This can occur if the windshield or headlamps are blocked by dirt, snow, or ice; if they are not in proper condition; or if the sun shines directly into the camera.
- Detect road edges.
- Detect lanes on winding or hilly roads.

If LKA only detects lane markings on one side of the road, it will only assist or provide an LDW alert when approaching the lane on the side where it has detected a lane marking. Even with LKA and LDW, you must steer the vehicle.

Always keep your attention on the road and maintain proper vehicle position within the lane, or vehicle damage, injury, or death could occur. Always keep the windshield, headlamps, and camera

(Continued)

Warning (Continued)

sensors clean and in good repair. Do not use LKA in bad weather conditions or on roads with unclear lane markings, such as construction zones.

Warning

Using LKA on slippery roads could cause loss of control of the vehicle and a crash. Turn the system off.

Warning





LKA will not alert the driver if a towed trailer crosses into an adjacent lane of travel. Serious injury or property damage may occur if the trailer moves into another lane. Always monitor the trailer position while towing to make sure it is within the same lane as the tow vehicle.

How the System Works

LKA uses a camera sensor installed on the windshield ahead of the rearview mirror to detect lane markings. It may provide brief steering assist if it detects an unintended

lane departure. It may further provide an audible alert or the driver seat may pulse indicating that a lane marking has been crossed. The system does not provide an LDW when intentionally steering across a lane marker.

To turn LKA on and off, press  on the center stack. If equipped, the indicator light on the button comes on when LKA is on and turns off when LKA is disabled. In some vehicles a long press of over three seconds is required to turn LKA off

When on,  is white, if equipped, indicating that the system is not ready to assist.  is green if LKA is ready to assist. LKA may assist by gently turning the steering wheel if the vehicle approaches a detected lane marking.  is amber when assisting. It may also provide a Lane Departure Warning (LDW) alert by flashing  amber if the vehicle crosses a detected lane marking. Additionally, there may be three beeps, or the driver seat may pulse three times, on the right or left, depending on the lane departure direction.

Take Steering

The LKA system does not continuously steer the vehicle. If LKA does not detect active driver steering, an alert and chime may be provided. Steer the vehicle to dismiss. LKA may become temporarily unavailable after repeated take steering alerts.

When the System Does Not Seem to Work Properly

The system performance may be affected by:

- Close vehicles ahead.
- Sudden lighting changes, such as when driving through tunnels.
- Banked roads.
- Roads with poor lane markings, such as two-lane roads.

If the LKA system is not functioning properly when lane markings are clearly visible, cleaning the windshield may help.

A camera blocked message may display if the camera is blocked. Some driver assistance systems may have reduced performance or not work at all. An LKA or LDW unavailable message may display if the systems are temporarily unavailable. This message could be due to a blocked camera.

The LKA system does not need service. Clean the outside of the windshield behind the rearview mirror.

LKA assistance and/or LDW alerts may occur due to tar marks, shadows, cracks in the road, temporary or construction lane markings, or other road imperfections. This is normal system operation; the vehicle does not need service. Turn LKA off if these conditions continue.

Charging

When to Charge

When the high voltage battery is low, the following charging messages may display on the Driver Information Center (DIC):

CHARGE VEHICLE SOON : The battery needs to be charged soon.

REDUCED ACCELERATION DRIVE WITH CARE : The accelerator pedal response is reduced and the remaining range value changes to LOW, charge the vehicle immediately.

OUT OF ENERGY, CHARGE VEHICLE NOW : The battery charge is fully depleted. The vehicle will slow to a stop. Brake and

steering assist will continue operating. Once stopped, turn the vehicle off. See *Propulsion Power Messages* ⇨ 74.

Plug-In Charging

Plug-in charge times vary based on the battery condition, charge level, and the outside temperature. See *Charging* ⇨ 66 for charge mode selection.

Do not allow the vehicle to remain in temperature extremes for long periods without being driven or plugged in. When temperatures are below 0 °C (32 °F) and above 32 °C (90 °F), plug in the vehicle to maximize high voltage battery life.

It is normal to hear fans, pumps, and electrical devices clicking while the vehicle is turned off and charging.

Charging will slow down as the battery fills up. Charge the battery to 80% for daily driving, or when driving in mountainous terrain. The vehicle can be charged above 80% for long trips when not driving in mountainous terrain.

The vehicle does not require indoor charging area ventilation before, during, or after charging.

The vehicle cannot be driven while the charge cord is plugged into the vehicle.

Warning

Make sure the charging cord plug and terminal are in good condition, free from debris, not worn or damaged, and connected securely to the vehicle charging port. If vehicle charging is intermittent, disconnect the cord and inspect for damage. A worn or damaged terminal, or AC or DC charging cord plug may result in personal injury and/or damage to the vehicle, the charging port or other property.

There are several infotainment screens that will display depending on the current charging status. See *Charging* ⇨ 66.

Charging Override

A CHARGING OVERRIDE/INTERRUPTION OCCURRED message may display to indicate that a charging override or interruption has occurred due to one or more of the following events:

- Override of the charge settings by the owner.

- Unintended interruption of AC power at the vehicle charge port.
- Interruption of charging by the utility company.

AC Charging

A loss of AC power alert may sound for a short time if AC power is lost for over one minute. This sound alert can be turned off. See *Charging* ⇨ 66.



AC Charge Cord Vehicle Plug

To Start AC Charging

1. Put the vehicle in P (Park).
2. Push and release near the center of the rear edge of the charge port door to release the latch. Swing open the charge port door.

In cold weather conditions, ice may form around the charge port door. Remove ice from the area before attempting to open or close the charge port door.



3. Remove the charge cord from storage case.
4. Plug the charge cord into the electrical outlet. To verify the charge cord status, see *Electrical Requirements for Battery Charging* ⇨ 168. For instructions to set cord limit settings for a charge session, see *Charging* ⇨ 66.



5. Plug in the AC charge cord into the vehicle charge port . Make sure the AC vehicle plug is fully connected to the AC charge port. If it is not properly connected, the vehicle may not be charged.
6. Verify that the charge port light illuminates and an audible chirp occurs. See *Charging Status Feedback* ⇨ 165.

To End AC Charging

1. Unlock the charge cord from the vehicle by pressing the button on the top of the charge cord plug. Unplug the charge cord from the vehicle.

2. Swing close the charge port door. Press the charge port door firmly and release near the center of the rear edge until it latches.
3. Unplug the charge cord from the electrical outlet.
4. Place the charge cord into the storage case.

DC Charging

DC Charging Station Hardware

The vehicle can be charged using DC charging equipment typically found at service stations and other public locations.

Check the charging station DC vehicle plug for compatibility with the DC charge port on this vehicle. This vehicle is compatible with a CCS1 connector.

When recharging at a DC charge station, the charging cable connected to the vehicle must be less than 10 m (33 ft) in length to meet functionality and regulatory requirements.

Warning

Do not use the charging station if the handle has defects such as cracks, exposed wires, burnt or missing pins, or any other damage. A damaged handle may result in personal injury and/or damage to the vehicle, the charging port or other property.

For maximum charging performance, and to prevent charging interruptions or damage to the high voltage battery and vehicle:

- Remove your hands from the charging handle once it has been plugged in. If not done, this can cause a charging interruption.
- Ensure that the charge cord plug clicks.

Follow the steps listed on the charging station to perform a DC vehicle charge.

If for any reason DC charging does not begin or is interrupted, check the DC charging station display for messages. Unplug the cord to restart the DC charging process.

To Start DC Charging

1. Put the vehicle in P (Park).
2. Push and release near the center of the rear edge of the charge port door to release the latch. Swing open the charge port door.

In cold weather conditions, ice may form around the charge port door. The charge port door may not open on the first attempt. Remove ice from the area and repeat attempting to open the charge port door.



3. Unlatch the DC charging dust cover and lower it fully.

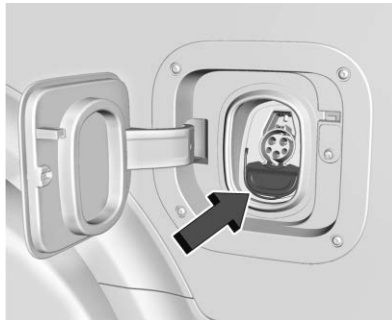

4. Plug in the DC charge cord into the vehicle charge port. Make sure that the DC vehicle plug is fully connected to the DC charge port. If it is not properly connected, the vehicle may not be charged. Check the Driver Information Center (DIC) to make sure the vehicle plug is connected properly.
5. Follow the steps listed on the charging station to start charging.
6. When charging is active, the DC vehicle plug is locked to the DC charge port and cannot be disconnected.
7. Verify that the charge port light illuminates and an audible chirp occurs. See *Charging Status Feedback* ⇨ 165.

Caution

Do not attempt to disconnect the DC vehicle plug while charging is active. This action may damage the vehicle or charging station hardware.

To Stop DC Charging — Automatic

When the vehicle no longer needs power from the charging station, it stops charging and the DC vehicle plug unlocks from the DC charge port.

Energy can still be consumed from the charging station when the vehicle displays and indicators show that the battery is fully charged. This is to ensure the battery is in optimal temperature operating range to maximize vehicle range. See *Charging* ⇨ 66.

To End DC Charging

When the vehicle is fully charged, charging automatically stops and the plug unlocks. You can also manually stop charging using the button on the DC vehicle plug, the controls at the charging station or by tapping "Stop" on the Charging page on your infotainment screen.

If the vehicle plug does not unlock from the vehicle charge port after a charge, contact your dealer.

1. Unplug the DC vehicle plug from the DC charge port on the vehicle and close the dust cover.
2. Swing close the charge port door. Press the charge port door firmly and release near the center of the rear edge until it latches.

Emergency Manual Charge Cord Release

The charge cord is equipped with an emergency manual charge cord release in the event the cord cannot be released normally in DC charging.

1. Open the rear cargo door. See *Sliding Door (Bulkhead Door)* ⇨ 16.



2. Remove plastic plug.



3. Gently pull the emergency manual charge cord release handle. The DC charge cord will release.

To Stop AC or DC Charging

Controls on the charging station can be used to stop the charge process at any time.

To stop charging when inside the vehicle, use the Stop Charge button on the Charging screen. See “Active Charging” under *Charging* ⇨ 66.

Delayed Charging Override

To temporarily override a delayed charge event, unplug the charge cord from the charge port and then plug it back in within five seconds. A single audible chirp will sound and charging will begin immediately.

To cancel a temporary override, unplug the charge cord, wait for 10 seconds, and then plug the charge cord back in. A double audible chirp will sound and charging will be delayed.

See *Charging* ⇨ 66 for advanced charge scheduling options.

Charging Status Feedback

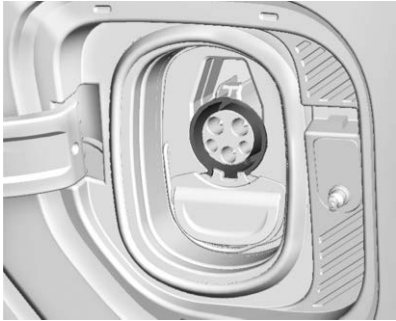

The vehicle is equipped with a charge port light. When the charge cord is plugged in, a color appears to indicate the charging status.

Following is the charge port light feedback when the charge cord is plugged in.

166 Driving and Operating

Charge Port Light Color	Sound	Action/Reason
Solid Blue	None	Initial connection is successful.
Pulsing Blue	Two audible chirps	Charging is delayed by charging screen or by a total utility interruption. Charging will begin later. See <i>Utility Interruption of Charging</i> ⇨ 167.
Blinking Green (the longer the blink, the higher the state of charge)	One audible chirp	Vehicle is actively charging.
Solid Green	None	Charging is complete.
Pulsing Red	None	There is a charging error. Check the charge cord connection. There may be no power supplied to the vehicle.
Blinking Green	Four audible chirps	There is not enough time to fully charge the vehicle by the selected departure time. Perform a delayed charging override to increase the battery charging speed. See <i>Delayed Charging Override</i> ⇨ 164.
None (upon plug-in)	None	Check the charge cord connection.

Charge Port Light Color	Sound	Action/Reason
None (after blue and green lights up)	None	Check the charge cord connection. If the connection is good, this may indicate a power failure or a total utility interruption, and charging will begin later. It may also occur if a high voltage charging system fault is detected. See <i>Utility Interruption of Charging</i> ⇨ 167 or <i>Service Vehicle Soon Light (Propulsion System Failure)</i> ⇨ 61.
None	Three audible chirps when the driver door is opened	The charge port door is open.

Utility Interruption of Charging

This vehicle responds to requests through the utility company to limit or completely block electrical power grid use. This feature is inactive during DC charging. A utility interruption will lengthen the vehicle charge time.

When electrical grid power is completely blocked, the vehicle will not charge until the utility interruption has expired. The vehicle should be left plugged in so that the vehicle will automatically resume charging.

Changing the charge mode to Charge Now or performing a delayed charging override will not disable a utility interruption.

A message will display on the instrument cluster indicating that a utility interruption has occurred.

Charging Station Troubleshooting

If the vehicle does not charge after being plugged in to a residential 240-volt charging station:

- Verify that the charging station is powered-on and is not displaying any error lights or warnings. Follow the charging station's directions to troubleshoot any issues.
- Verify that your vehicle and OnStar application is not displaying any vehicle errors/faults.
- Verify that the charge mode is set to Charge Now on the Charging Screen. See *Charging* ⇨ 66
- If possible, attempt to charge a different vehicle at this charge station. If no issue is found, see your dealer for service.
- Attempt to charge your vehicle with a known good charge station or the Charge Cord, if purchased for your vehicle. If your vehicle successfully charges with another charge station or Charge Cord there may be a problem with the first charge station. If the vehicle will not charge with any other charge stations or Charge Cords, see your dealer for service.

Electrical Requirements for Battery Charging

This vehicle is compatible with most electric vehicle supply equipment (EVSE) that complies with one or more of the following standards:

- SAE J1772, J2847
- IEC 61851, 62196
- ISO 15118
- DIN 70121

Consult your dealer before purchasing and using charging equipment. See the “Active Charging” section under *Charging* ⇨ 66.

Caution

Do not use portable or stationary backup generating equipment to charge the vehicle. This may cause damage to the vehicle's charging system. Only charge the vehicle from utility supplied power.

Trailer Towing

General Towing Information

Warning

Never tow a trailer with your vehicle. It was not designed or intended to tow a trailer.

Conversions and Add-Ons

Add-On Electrical Equipment

Warning

The Data Link Connector (DLC) is used for vehicle service and Emission Inspection/Maintenance testing. See *Service Vehicle Soon Light (Propulsion System Failure)* ⇨ 61. A device connected to the DLC — such as an aftermarket fleet or driver-behavior tracking device — may interfere with vehicle systems. This could affect vehicle operation and cause a crash. Such devices may also access information stored in the vehicle's systems.

Caution

Some electrical equipment can damage the vehicle or cause components to not work and would not be covered by the vehicle warranty. Always check with your dealer before adding electrical equipment.

Add-on equipment can drain the vehicle's 12-volt battery, even if the vehicle is not operating.

When adding electrical equipment, it should only be connected using the accessory power outlets. The maximum power that can be supplied by one accessory power outlet or spread across all three is 200 watts or 15 amps. Exceeding 200 watts or 15 amps may cause erratic vehicle operation.

The vehicle has an airbag system. Before attempting to add anything electrical to the vehicle, see *Servicing the Airbag-Equipped Vehicle* ⇨ 41 and *Adding Equipment to the Airbag-Equipped Vehicle* ⇨ 41.

Vehicle Care

General Information

General Information	170
California Perchlorate Materials Requirements	170
Accessories and Modifications	170

Vehicle Checks

Doing Your Own Service Work	170
Hood	171
Underhood Compartment Overview ...	174
Cooling System	175
Washer Fluid	175
Brakes	176
Brake Fluid	177
Battery - North America	177
Noise Control System	180
Wiper Blade Replacement	180
Windshield Replacement	181

Headlamp Aiming

Front Headlamp Aiming	181
-----------------------------	-----

Bulb Replacement

Bulb Replacement	181
LED Lighting	181

Electrical System

High Voltage Devices and Wiring	181
Electrical System Overload	182

Fuses and Circuit Breakers	183
Underhood Compartment Fuse Block	183
Instrument Panel Fuse Block	187

Wheels and Tires

Tires	189
All-Season Tires	190
Winter Tires	190
Tire Sidewall Labeling	191
Tire Designations	192
Tire Terminology and Definitions	192
Tire Pressure	194
Tire Pressure Monitor System	195
Tire Pressure Monitor Operation	196
Tire Inspection	198
Tire Rotation	198
When It Is Time for New Tires	200
Buying New Tires	200
Different Size Tires and Wheels	202
Uniform Tire Quality Grading	202
Wheel Alignment and Tire Balance ...	203
Wheel Replacement	203
Tire Chains	204
If a Tire Goes Flat	204
Tire Changing	205
Full-Size Spare Tire	215

Jump Starting

Jump Starting - North America	215
-------------------------------------	-----

Towing the Vehicle

Transporting a Disabled Vehicle	218
---------------------------------------	-----

Appearance Care

Exterior Care	219
Interior Care	224
Floor Mats	227

General Information

For service and parts needs, visit your dealer. You will receive genuine GM parts and GM-trained and supported service people.

Genuine GM parts have one of these marks:



ACDelco

California Perchlorate Materials Requirements

Certain types of automotive applications, such as airbag initiators, seat belt pretensioners, and lithium batteries contained in electronic keys, may contain

perchlorate materials. Perchlorate Material – special handling may apply. See www.dtsc.ca.gov/hazardouswaste/perchlorate.

Accessories and Modifications

Adding non-dealer accessories or making modifications to the vehicle can affect vehicle performance and safety, including such things as airbags, braking, stability, ride and handling, emissions systems, aerodynamics, durability, Driver Assistance Systems, and electronic systems like antilock brakes, traction control, and stability control. These accessories or modifications could even cause malfunction or damage not covered by the vehicle warranty.

Damage to suspension components caused by modifying vehicle height outside of factory settings will not be covered by the vehicle warranty.

Damage to vehicle components resulting from modifications or the installation or use of non-GM certified parts, including control module or software modifications, is not covered under the terms of the vehicle warranty and may affect remaining warranty coverage for affected parts.

GM Accessories are designed to complement and function with other systems on the vehicle. See your dealer to accessorize the vehicle using genuine GM Accessories installed by a dealer technician.

Also, see *Adding Equipment to the Airbag-Equipped Vehicle* ⇨ 41.

Vehicle Checks

Doing Your Own Service Work

Warning

Never try to do your own service on high voltage battery components. You can be injured and the vehicle can be damaged if you try to do your own service work. Service and repair of these high voltage battery components should only be performed by a trained dealer technician with the proper knowledge and tools.

Exposure to high voltage can cause shock, burns, and even death. The high voltage components in the vehicle can only be serviced by technicians with special training.

(Continued)

Warning (Continued)

High voltage components are identified by labels. Do not remove, open, take apart, or modify these components. High voltage cable or wiring has orange covering. Do not probe, tamper with, cut, or modify high voltage cable or wiring.

 Warning

Unexpected wheel motion and/or direction when one or more wheels are off the ground for service work may result in injury. The vehicle may:

- Allow the wheels to rotate unexpectedly in either direction regardless of mode selection.
- Allow the wheels to rotate in reaction to attempts to rotate the tire(s) manually.
- Resist attempts to rotate the wheels manually.

Before lifting the vehicle to do your own service work, turn the vehicle off or place the vehicle in the Service Mode. To place

(Continued)

Warning (Continued)

the vehicle in Service Mode, with the vehicle off and the brake pedal not applied, press and hold POWER for more than five seconds.

 Warning

It can be dangerous to work on your vehicle if you do not have the proper knowledge, service manual, tools, or parts. Always follow owner's manual procedures and consult the service manual for your vehicle before doing any service work.

If doing some of your own service work, use the proper service manual. It tells you much more about how to service the vehicle than this manual can. To order the proper service manual, see *Publication Ordering Information* ⇨ 237.

This vehicle has an airbag system. Before attempting to do your own service work, see *Servicing the Airbag-Equipped Vehicle* ⇨ 41.

Keep a record with all parts receipts and list the mileage and the date of any service work performed. See *Maintenance Records* ⇨ 234.

Hood** Warning**

Components under the hood can get hot during vehicle operation. To help avoid the risk of burning unprotected skin, never touch these components until they have cooled, and always use a glove or towel to avoid direct skin contact.

Clear any snow from the hood before opening.

To open the hood:

Pull the hood release lever twice (x2) with the  symbol. It is on the lower left side of the instrument panel.

Walk to the front of the vehicle and gently lower the hood to the open position.

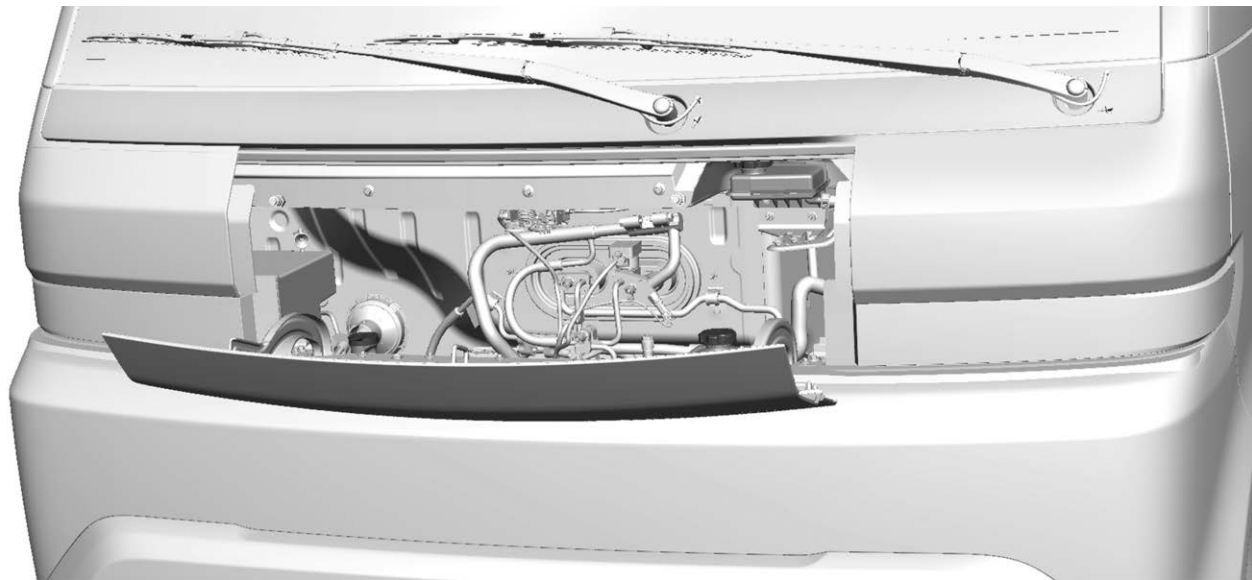

To close the hood:

1. Before closing the hood, be sure all filler caps are on properly, and all tools are removed.
2. Lift the hood up until it is securely latched into position.

 **Warning**

To avoid personal injury and/or vehicle damage, make sure the hood is securely closed before driving. Failure to latch the hood properly may permit the hood to open unexpectedly.

Underhood Compartment Overview

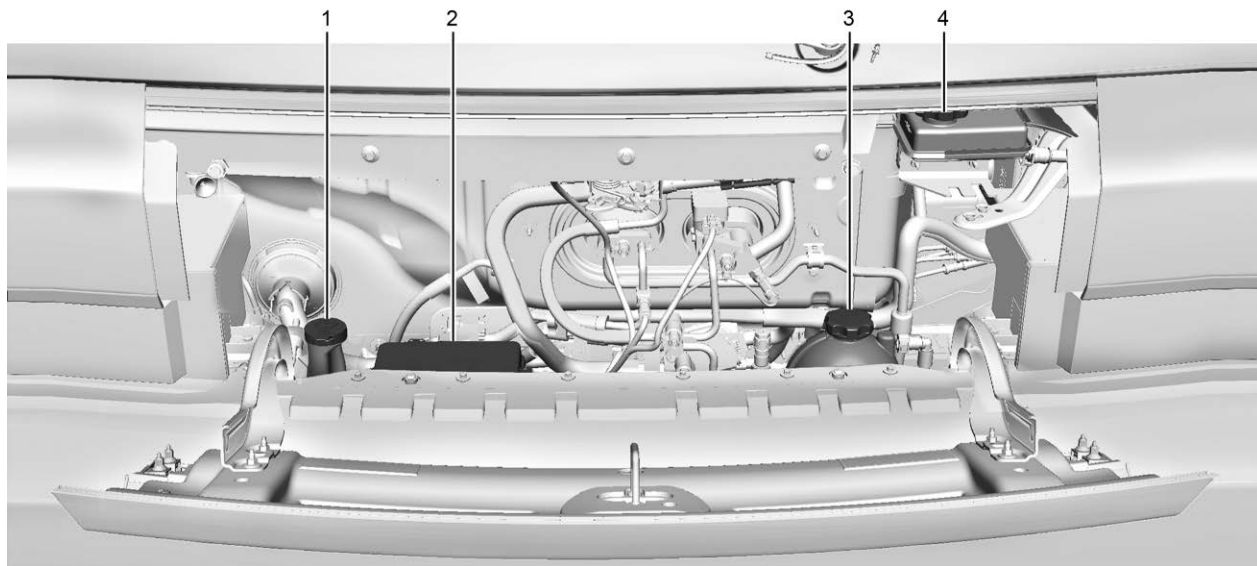

1. Windshield Washer Fluid Reservoir. See *Washer Fluid* ⇨ 175.
2. Underhood Compartment Fuse Block. *Underhood Compartment Fuse Block* ⇨ 183.
3. Coolant Surge Tank and Pressure Cap. See *Cooling System* ⇨ 175.
4. Brake Fluid Reservoir. See *Brake Fluid* ⇨ 177.

Cooling System

It is not necessary to regularly check coolant unless a leak is suspected or an unusual noise is heard. A coolant loss could indicate a problem. Have it inspected and repaired by your dealer.

The following explains the cooling system and how to check coolant level.

During vehicle operation and also during charging, the high voltage battery cells in the vehicle are kept within a normal operating temperature range. If the temperature rises above this temperature, the battery cooling system turns on the air conditioning compressor and cools the coolant until the correct temperature is reached. If the temperature falls below this temperature, a high voltage heater, located

outside the battery on a cradle, heats the coolant until the correct temperature is reached.

Checking Coolant

The coolant needs to be replaced at the appropriate interval. See *Maintenance Schedule* ⇨ 229.

The coolant reservoir is in the underhood compartment. See *Underhood Compartment Overview* ⇨ 174.

1. Park on a level surface and turn the vehicle off.
2. Open the hood. See *Hood* ⇨ 171.
3. After the system has completely cooled, check that the coolant level is at the cold fill mark on the reservoirs.

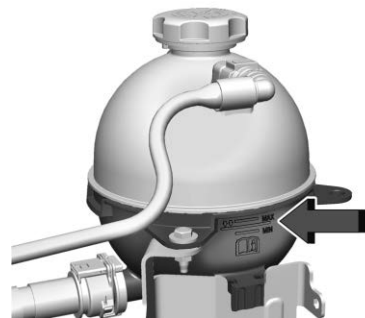

4. If the coolant level is not visible or needs to be adjusted within the reservoir, contact your dealer.

Washer Fluid

What to Use

When windshield washer fluid is needed, be sure to read the manufacturer's instructions before use. If operating the vehicle in an area where the temperature may fall below freezing, use a fluid that has sufficient protection against freezing.

Adding Washer Fluid

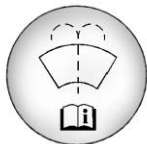

Open the cap with the washer symbol on it. Add washer fluid until the tank is full. See *Underhood Compartment Overview* ⇨ 174 for reservoir location.

Caution

- Do not use washer fluid that contains any type of water repellent coating. This can cause the wiper blades to chatter or skip.
- Do not use engine coolant (antifreeze) in the windshield washer. It can damage the windshield washer system and paint.
- Do not mix water with ready-to-use washer fluid. Water can cause the solution to freeze and damage the washer fluid tank and other parts of the washer system.

(Continued)

Caution (Continued)

- When using concentrated washer fluid, follow the manufacturer instructions for adding water.
- Fill the washer fluid tank only three-quarters full when it is very cold. This allows for fluid expansion if freezing occurs, which could damage the tank if it is completely full.

Brakes

Disc brake linings have built-in wear indicators that make a high-pitched warning sound when the brake linings are worn and new linings are needed. The sound can come and go or can be heard all the time when the vehicle is moving, except when applying the brake pedal firmly.

Warning

The brake wear warning sound means that soon the brakes will not work well. That could lead to a crash. When the brake wear warning sound is heard, have the vehicle serviced.

Caution

Continuing to drive with worn-out brake linings could result in costly brake repairs.

Some driving conditions or climates can cause a brake squeal when the brakes are first applied, clearing up following several applications. This does not mean something is wrong with the brakes.

Properly torqued wheel nuts are necessary to help prevent brake pulsation. When tires are rotated, inspect brake linings for wear and evenly tighten wheel nuts in the proper sequence to torque specifications. See *Capacities and Specifications* ⇨ 236.

Brake pads should be replaced as complete axle sets.

Brake Pedal Travel

See your dealer if the brake pedal does not return to normal height, or if there is a rapid increase in pedal travel. This could be a sign that brake service may be required.

Replacing Brake System Parts

Always replace brake system parts with new, approved replacement parts. If this is not done, the brakes may not work properly. The braking performance can change in many ways if the wrong brake parts are installed or if parts are improperly installed.

Brake Fluid



The brake master cylinder reservoir is filled with GM approved DOT 4 brake fluid as indicated on the reservoir cap. See *Underhood Compartment Overview* ⇨ 174 for the location of the reservoir.

Checking Brake Fluid

With the vehicle in P (Park) on a level surface, the brake fluid level should be between the minimum and maximum marks on the brake fluid reservoir.

There are only two reasons why the brake fluid level in the reservoir may go down:

- Normal brake lining wear. When new linings are installed, the fluid level goes back up.
- A fluid leak in the brake hydraulic system. Have the brake hydraulic system fixed. With a leak, the brakes will not work well.

Always clean the brake fluid reservoir cap and the area around the cap before removing it.

Do not top off the brake fluid. Adding fluid does not correct a leak. If fluid is added when the linings are worn, there will be too much fluid when new brake linings are installed. Add or remove fluid, as necessary, only when work is done on the brake hydraulic system.

When the brake fluid falls to a low level, the brake warning light comes on. See *Brake System Warning Light* ⇨ 61.

Brake fluid absorbs water over time which degrades the effectiveness of the brake fluid. Replace brake fluid at the specified intervals to prevent increased stopping distance. See *Maintenance Schedule* ⇨ 229.

What to Add

Use only GM approved DOT 4 brake fluid from a clean, sealed container. See *Recommended Fluids and Lubricants* ⇨ 232.

Warning

The wrong or contaminated brake fluid could result in damage to the brake system. This could result in the loss of braking leading to a possible injury. Always use the proper GM approved brake fluid.

Caution

If brake fluid is spilled on the vehicle's painted surfaces, the paint finish can be damaged. Immediately wash off any painted surface.

Battery - North America

This vehicle has a high voltage battery and a standard 12-volt battery.

See your dealer if either the 12-volt or high voltage battery needs service.

12-Volt Battery

The original equipment battery is maintenance free. Do not remove the cap and do not add fluid.

Refer to the replacement number shown on the original battery label when a new 12-volt battery is needed. The vehicle has an Absorbent Glass Mat (AGM) 12-volt battery. Installation of a standard 12-volt battery will result in reduced 12-volt battery life.

Some 12-volt chargers have an AGM battery setting. This setting limits the charge voltage to 14.8 volts and helps extend the battery life. If available, use the AGM setting when charging the battery.

Warning

WARNING: Battery posts, terminals and related accessories can expose you to chemicals including lead and lead compounds, which are known to the State of California to cause cancer and birth defects or other reproductive harm. Wash hands after handling. For more information go to www.P65Warnings.ca.gov.

See *California Proposition 65 Warning* ⇨ 1.

High Voltage Battery

Only a trained service technician should inspect, test, or replace the high voltage battery. The dealer has information on how to recycle the high voltage battery. There is also information available at <https://www.recyclemybattery.com>.

Warning

Damage to the high voltage battery or high voltage system can create a risk of electric shock, overheating, or fire.

If the vehicle is damaged from a moderate to severe crash, flood, fire, or other event, the vehicle should be inspected as soon as possible. Until the vehicle has been inspected, store it outside at least 15 m (50 ft) from any structure or anything that can burn. Ventilate the vehicle by opening a window or a door.

Contact your dealer as soon as possible to determine whether an inspection is needed.

If the vehicle is in a crash, the sensing system may shut down the high voltage system. When this occurs, the high voltage

battery is disconnected and the vehicle will not start. The SERVICE VEHICLE SOON message in the Driver Information Center (DIC) will display. Before the vehicle can operate again, it must be serviced at your dealer. If an airbag(s) inflates, see *What Will You See after an Airbag Inflates?* ⇨ 40 for additional information.

Keep the vehicle plugged in, even when fully charged, to keep the high voltage battery temperature ready for the next drive. This is important when outside temperatures are extremely hot or cold.

Propulsion power may be reduced in extremely cold temperatures, or if the high voltage battery is too cold. The message BATTERY TOO COLD, PLUG IN TO WARM will display. If the message displays, a level 2 charger is required to heat the battery to a minimum temperature to enable propulsion or charging.

See *Radio Frequency Statement* ⇨ 237.

Federal Communications Commission (FCC) Radiation Exposure Statement

This equipment has been evaluated to be installed and operated at a minimum distance of 5.7 cm (2.2 in) between the device and your body. The vehicle design

ensures this distance is maintained during normal use. Changes or modifications to any of these systems by other than an authorized service facility could void authorization to use this equipment.

Innovation, Science, and Economic Development (ISED) Radiation Exposure Statement

This equipment complies with RSS-102 radiation exposure limits set forth for an uncontrolled environment. This equipment should be installed and operated with a minimum distance of 5.7 cm (2.2 in) between the radiator and any part of your body. The vehicle design ensures this distance is maintained during normal use. Changes or modifications to any of these systems by other than an authorized service facility could void authorization to use this equipment.

Vehicle Storage

The best way to store the vehicle for any length of time is to plug in the charge cord and leave it plugged in. The vehicle monitors and maintains the 12-volt battery daily. It is okay to leave the vehicle plugged in for extended periods of time. Once

charged to full, very little energy is required to maintain the 12-volt battery and high voltage battery.

If it is not possible to charge the vehicle with the charge cord left plugged in, be sure to fully charge the high voltage battery before storing. The vehicle will stop maintenance of the 12-volt battery if the high voltage battery state of charge gets too low.

When storing the vehicle on a long-term basis:

- Keep the high voltage battery state of charge at 30%.
- Attach an AGM/VRLA compatible battery tender or trickle charger to the 12-volt battery.
- Keep the remote key more than 3 m (10 ft) away from the vehicle.

12-volt Battery

 Warning
<p>Batteries have acid that can burn you and gas that can explode. You can be badly hurt if you are not careful. Always wear</p> <p style="text-align: right;">(Continued)</p>

<p>Warning (Continued)</p>
<p>eye protection. See <i>Jump Starting - North America</i> ⇨ 215 for tips on working around a battery without getting hurt.</p>

A trickle charger may be attached to the 12-volt battery terminals or trickle charge from the underhood remote positive (+) and negative (-) terminals. See *Jump Starting - North America* ⇨ 215 for location of these terminals.

<p>Caution</p>
<p>The vehicle is equipped with an AGM/VRLA 12-volt battery, which can be damaged by using the incorrect type of trickle charger. An AGM/VRLA-compatible charger must be used, with the appropriate setting selected. Follow the trickle charger manufacturer instructions.</p>

With a trickle charger connected to the 12-volt battery, the vehicle will still monitor the 12-volt battery daily, but it will not use energy from the high voltage battery for maintenance.

High Voltage Battery

After extended storage, it is possible that the vehicle may not operate. If this happens, the high voltage battery may need to be plugged in and charged.

Noise Control System

NOISE EMISSIONS WARRANTY

General Motors LLC, warrants to the first person who purchases this vehicle for purposes other than resale and to each subsequent purchaser that this vehicle as manufactured by General Motors LLC, was designed, built and equipped to conform at the time it left General Motors LLC's control with all applicable U.S. EPA Noise Control Regulations. This warranty covers this vehicle as designed, built and equipped by General Motors LLC, and is not limited to any particular part, component or system of the vehicle manufactured by General Motors LLC. Defects in design, assembly or in any part, component or system of the vehicle as manufactured by General Motors LLC, which, at the time it left General Motors LLC's control, caused noise emissions to exceed Federal standards, are covered by this warranty for the life of the vehicle.

TAMPERING WITH NOISE CONTROL SYSTEM PROHIBITED

Federal law prohibits the following acts or the causing thereof:

1. The removal or rendering inoperative by any person, other than for purposes of maintenance, repair, or replacement, of any device or element of design incorporated into any new vehicle for the purpose of noise control prior to its sale or delivery to the ultimate purchaser or while it is in use; or
2. the use of the vehicle after such device or element of design has been removed or rendered inoperative by any person.

Among those acts presumed to constitute tampering are the acts listed below.

Insulation:

Removal of the noise shields or any undercab insulation.

Fan and Drive:

Removal of fan clutch or rendering clutch inoperative.

Removal of fan shroud.

External Sound System:

Modification of the vehicle's external sound system.

Wiper Blade Replacement

Windshield wiper blades should be replaced periodically. See the *Maintenance Schedule* ⇨ 229.

Replacement blades come in different types and are removed in different ways. For proper type and length, see *Maintenance Replacement Parts* ⇨ 233.

Caution
<p>Allowing the wiper arm to touch the windshield when no wiper blade is installed could damage the windshield. Any damage that occurs would not be covered by the vehicle warranty. Do not allow the wiper arm to touch the windshield.</p>

To replace the windshield wiper blade:

1. Pull the windshield wiper assembly away from the windshield.



2. Pull the wiper blade assembly down toward the windshield far enough to release it from the J-hooked end of the wiper arm
3. Remove the wiper blade.
4. Reverse Steps 1–3 for wiper blade replacement.

Windshield Replacement

Driver Assistance Systems

If the windshield needs to be replaced and the vehicle is equipped with a front camera sensor for the Driver Assistance Systems, a GM replacement windshield is recommended. The replacement windshield must be installed according to GM

specifications for proper alignment. If it is not, these systems may not work properly, they may display messages, or they may not work at all. See your dealer for proper windshield replacement.

Headlamp Aiming

Front Headlamp Aiming

Headlamp aim has been preset and should need no further adjustment.

If the vehicle is damaged in a crash, the headlamp aim may be affected. If adjustment to the headlamps is necessary, see your dealer.

Bulb Replacement

For the proper type of replacement bulbs, or any bulb changing procedure not listed in this section, contact your dealer.

Caution

Do not replace incandescent bulbs with aftermarket LED replacement bulbs. This can cause damage to the vehicle electrical system.

LED Lighting

This vehicle has several LED lamps.

For replacement of any LED lighting assembly, contact your dealer.

Electrical System

High Voltage Devices and Wiring

Warning

Exposure to high voltage can cause shock, burns, and even death. The high voltage components in the vehicle can only be serviced by technicians with special training.

High voltage components are identified by labels. Do not remove, open, take apart, or modify these components. High voltage cable or wiring has orange covering or labels. Do not probe, tamper with, cut, or modify high voltage cable or wiring.

Electrical System Overload

The vehicle has fuses and circuit breakers to protect against an electrical system overload.

When the current electrical load is too heavy, the circuit breaker opens and closes, protecting the circuit until the current load returns to normal or the problem is fixed. This greatly reduces the chance of circuit overload and fire caused by electrical problems.

Fuses and circuit breakers protect the wires that provide the power to the devices in your vehicle.

If there is a problem on the road and a fuse needs to be replaced, the same amperage fuse can be borrowed. Choose some feature of the vehicle that is not needed to use and replace it as soon as possible.

To check a fuse, look at the band inside the fuse. If the band is broken or melted, replace the fuse. Be sure to replace a bad fuse with a fuse of the identical size and rating.

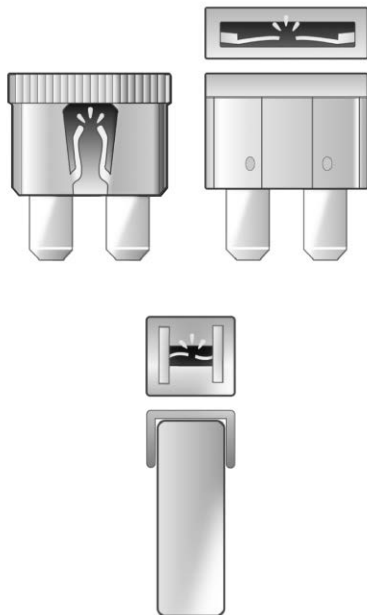

Replacing a Blown Fuse

1. Turn off the vehicle.
2. Locate the fuse puller in the underhood compartment fuse block.

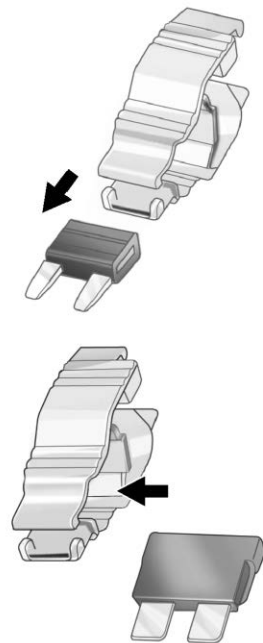

3. Use the fuse puller to remove the fuse from the top or side, as shown above.

4. If the fuse must be replaced immediately, borrow a replacement fuse with the same amperage from the fuse block. Choose a vehicle feature that is not needed to safely operate the vehicle. Repeat Steps 2–3.
5. Insert the replacement fuse into the empty slot of the blown fuse.

At the next opportunity, see your dealer to replace the blown fuse.

Headlamp Wiring

An electrical overload may cause the lamps to go on and off, or in some cases to remain off. Have the headlamp wiring checked right away if the lamps go on and off or remain off.

Windshield Wipers

If the wiper motor overheats due to heavy snow or ice, the windshield wipers will stop until the motor cools and will then restart.

Although the circuit is protected from electrical overload, overload due to heavy snow or ice may cause wiper linkage damage. Always clear ice and heavy snow from the windshield before using the windshield wipers.

If the overload is caused by an electrical problem and not snow or ice, be sure to get it fixed.

Fuses and Circuit Breakers

The wiring circuits in the vehicle are protected from short circuits by a combination of fuses and circuit breakers. This greatly reduces the chance of damage caused by electrical problems.

Danger

Fuses and circuit breakers are marked with their ampere rating. Do not exceed the specified amperage rating when replacing fuses and circuit breakers. Use of an oversized fuse or circuit breaker can result in a vehicle fire. You and others could be seriously injured or killed.



Warning

Installation or use of fuses that do not meet GM's original fuse specifications is dangerous. The fuses could fail, and result in a fire. You or others could be injured or killed, and the vehicle could be damaged.

See *Accessories and Modifications* ⇨ 170 and *General Information* ⇨ 170.

To check or replace a blown fuse, see *Electrical System Overload* ⇨ 182.

Underhood Compartment Fuse Block

To Access:

1. Open the hood. See *Hood* ⇨ 171.

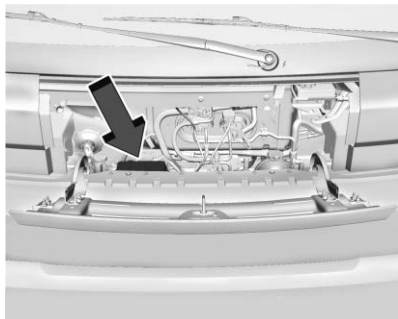

- Remove the cover to access the Underhood Compartment Fuse Block. To open the fuse block cover, press the clips at the side and back and pull the cover up.

Caution

Spilling liquid on any electrical component on the vehicle may damage it. Always keep the covers on any electrical component.

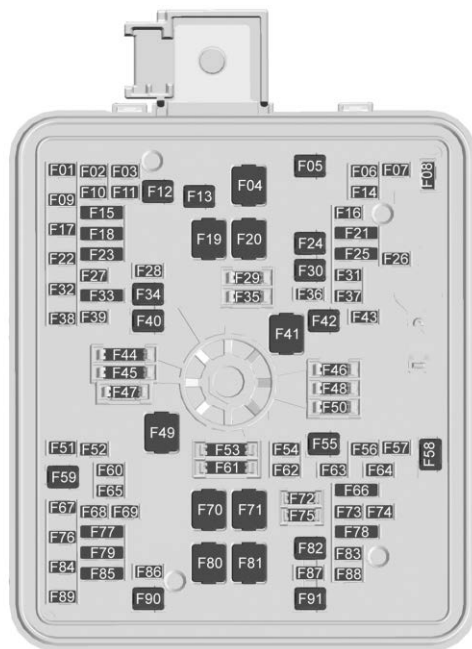

A fuse puller is in the underhood compartment fuse block.

There is a fuse label etched in the backside of the cover of the fuse block. Fuse amperage ratings are shown on the fuse label. When re-installing the cover, make sure the cover latches into place.

The vehicle may not be equipped with all of the fuses, relays, and features shown.

Fuses	Usage
F01	–
F02	Short Range Radars
F03	–
F04	–
F05	–
F06	Coolant Valve
F07	ESSCP – Energy Storage System Coolant Pump
F08	–
F09	PECP – Power Electronics Coolant Pump
F10	PCV/SCV/PEEV – Primary Coolant Valve/Secondary Coolant Valve/Primary Evaporator Expansion Valve
F11	–
F12	–
F13	–
F14	–

Fuses	Usage
F15	ACL/LRR – Ambient Color Lamp/Long Range Radar
F16	–
F17	REAR TPIM 2 – Rear Traction Power Inverter 2
F18	Front Heated Seats
F19	–
F20	–
F21	–
F22	ECFV/CHFV – External Condenser Flow Valve/Condensing Heating Flow Valve Motor
F23	VECM/Spare – Vehicle Integrated Control Module/Vehicle Extension Control Module/Spare
F24	–
F25	–
F26	–
F27	–
F28	–

Fuses	Usage
F29	Spare
F30	TRANS OIL PUMP – Transmission Oil Pump
F31	–
F32	REAR TPIM 1 – Rear Traction Power Inverter 1
F33	–
F34	–
F35	Spare
F36	TPIM 3 – Traction Power Inverter Module 3
F37	–
F38	–
F39	Rear Door Latch
F40	–
F41	–
F42	–
F43	–
F44	Spare
F45	Spare
F46	Spare

Fuses	Usage	Fuses	Usage	Fuses	Usage
F47	Spare		ELM 4 – Exterior Lighting	F77	–
F48	Spare	F65	Module 4 – Front Right Park Lamp/License Lamp	F78	–
F49	–		Spare/SBZA LT & RT –	F79	Spare/TPIM 2 – Spare/ Traction Power Inverter Module 2
F50	Spare	F66	Spare/Side Blind Zone Alert Left and Right	F80	–
F51	–	F67	–	F81	EBCM 1 – Electronic Brake Control Module 1
F52	–		ELM 3 – Exterior Lighting	F82	–
F53	Spare	F68	Module 3 – Reverse Lamps/ Right Rear Park Lamp	F83	Headlamp Right
F54	–		OSRVM DEFOG LT/RT –		ELM 7 – Exterior Lighting
F55	–	F69	Outside Rear View Mirror Defogger Left and Right		Module 7 – Front Left Park Lamp/Park ID Lamps/ Outside Rear View Mirrors
F56	–	F70	–	F84	Approach Lighting
F57	–		DC/AC INVERTER – Direct Current/Alternating Current Inverter		Spare/RLH SNSR/AAS – Spare/Rain Light Humidity Sensor/Auxiliary Alarm Sensor
F58	Front Wipers	F71	–	F85	–
F59	–	F72	Spare	F86	Horn
F60	–	F73	–	F87	Front Washer
F61	Spare	F74	–		ELM 5 – Exterior Lighting
F62	Headlamp Left	F75	Spare	F88	–
F63	–		ELM 5 – Exterior Lighting	F89	–
F64	–	F76	Module 5 – Left Low Beam Lamp/Wiper Relay		

Fuses	Usage
F90	-
F91	-

Instrument Panel Fuse Block

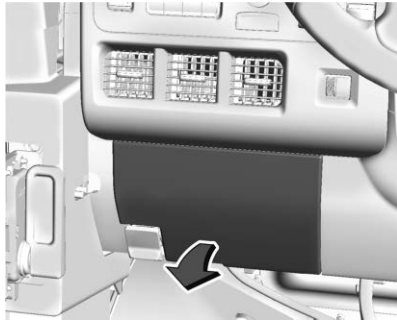

The instrument panel fuse block is on the driver side of the instrument panel, between the steering wheel and the door.

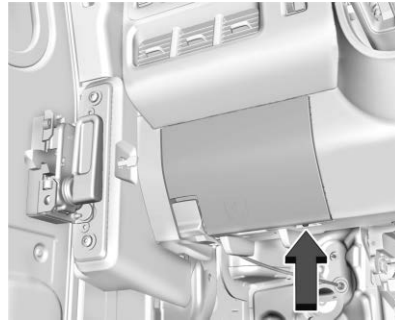

1. To access the fuses, use 7.0 mm Hex Socket to remove the screw on the bottom right side of the cover.
2. Remove the cover starting at the bottom. Once clips are disengaged, the tabs along the top of the cover can be disengaged from the instrument panel.

To reinstall the door, place the top tabs into the slots, and rotate the door into position, engaging the clips.

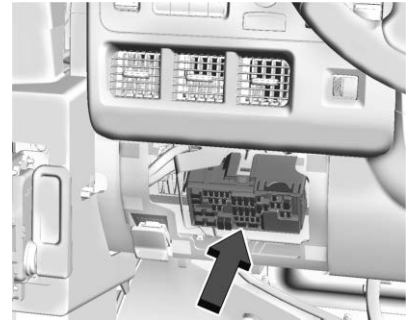

There is a fuse label in the top right pocket. Unfold it for individual fuse usage and locations. Fuse amperage ratings are shown on the fuse label. Fold label and put it back into the top right pocket.

The vehicle may not be equipped with all of the fuses, relays, and features shown.

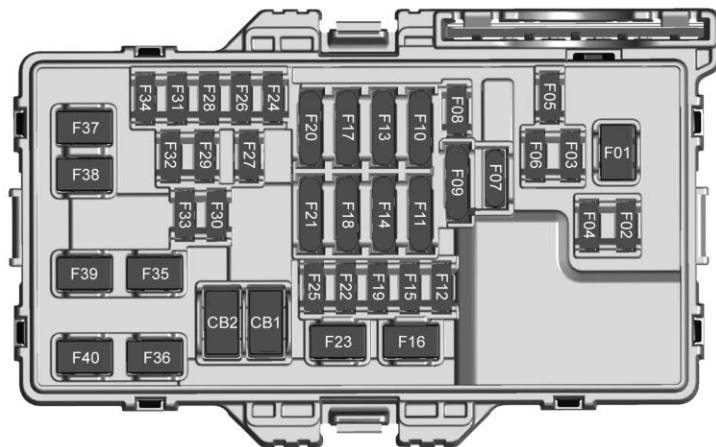

Fuses	Usage
F01	DOOR PANELS SWS – Door Panel Switches
F02	HSW – Heated Steering Wheel
F03	VICM/HVSL – Vehicle Integration Control/High Voltage System Lockout
F04	BCM 1 – Body Control Module 1

Fuses	Usage
F05	ELM 1 – Exterior Lighting Module
F06	BCM 2 – Body Control Module 2
F07	CCS – Coil Clock Spring
F08	CGM – Central Gateway Module
F09	–

Fuses	Usage
F10	DLC/VECM 2 – Data Link Connector/Vehicle Extension Control Module
F11	–
F12	–
F13	TPIM 1/SPARE – Traction Power Inverter Module 1/ Spare
F14	–
F15	–
F16	–
F17	SDM – PFA/PA – Sensing and Diagnostic Module/ Pedestrian Friendly Alert Module/Park Assist Module
F18	MISC 1 – Instrument Panel Cluster/Reflective Light Auxiliary/Shifter Interface Board

Fuses	Usage
F19	MISC 2– Vehicle Integration Control/Traction Power Inverter 2/Vehicle Extension Control/Traction Power Inverter 1/Electronic Brake Control
F20	ONSTAR/MISC 3 – OnStar/ Electric Park Break/Shifter Interface Board/Outside Rear View Mirror
F21	MISC DISPLYS/FCM – Display HVAC/Display IPC/ Display ICS/Front Camera/ External Object Calculating
F22	–
F23	–
F24	VICM – Vehicle Communications Interface Module
F25	–
F26	Auxiliary Jack
F27	–
F28	BCM 3 – Body Control Module 3

Fuses	Usage
F29	–
F30	–
F31	ELM 2 – Exterior Lighting Module 2
F32	RFA - Remote Function Actuator
F33	–
F34	ELM 6 – Exterior Lighting Module 6
F35	Amplifier
F36	HVAC BLOWER MTR – Heating, Ventilation, and Air Conditioning Blower Motor
F37	–
F38	–
F39	BCM 4 – Body Control Module 4
F40	CSM/AUX A/V JACK – Center Stack Module/ Auxiliary Audio/Video Jack

Circuit Breakers	Usage
CB01	–
CB02	FRONT APO – Front Auxiliary Power Outlet

Wheels and Tires

Tires

Every new GM vehicle has high-quality tires made by a leading tire manufacturer. See the warranty manual for information regarding the tire warranty and where to get service. For additional information refer to the tire manufacturer.

Warning

- Poorly maintained and improperly used tires are dangerous.
- Overloading the tires can cause overheating as a result of too much flexing. There could be a blowout and a serious crash. See *Vehicle Load Limits* ⇨ 117.

(Continued)

Warning (Continued)

- Underinflated tires pose the same danger as overloaded tires. The resulting crash could cause serious injury. Check all tires frequently to maintain the recommended pressure. Tire pressure should be checked when the tires are cold.
- Overinflated tires are more likely to be cut, punctured, or broken by a sudden impact — such as when hitting a pothole. Keep tires at the recommended pressure.
- Worn or old tires can cause a crash. If the tread is badly worn, replace them.
- Replace any tires that have been damaged by impacts with potholes, curbs, etc.
- Improperly repaired tires can cause a crash. Only your dealer or an authorized tire service center should repair, replace, dismount, and mount the tires.

(Continued)

Warning (Continued)

- Do not spin the tires in excess of 56 km/h (35 mph) on slippery surfaces such as snow, mud, ice, etc. Excessive spinning may cause the tires to explode.

All-Season Tires

This vehicle may come with all-season tires. These tires are designed to provide good overall performance on most road surfaces and weather conditions. Original equipment tires designed to GM's specific tire performance criteria have a TPC specification code molded onto the sidewall. Original equipment all-season tires can be identified by the last two characters of this TPC code, which will be "MS."

Consider installing winter tires on the vehicle if frequent driving on snow or ice-covered roads is expected. All-season tires provide adequate performance for most winter driving conditions, but they may not offer the same level of traction or performance as winter tires on snow or ice-covered roads. See *Winter Tires* ⇨ 190.

Winter Tires

This vehicle was not originally equipped with winter tires. Winter tires are designed for increased traction on snow and ice-covered roads. Consider installing winter tires on the vehicle if frequent driving on ice or snow covered roads is expected. See your dealer for details regarding winter tire availability and proper tire selection. Also, see *Buying New Tires* ⇨ 200.

With winter tires, there may be decreased dry road traction, increased road noise, and shorter tread life. After changing to winter tires, be alert for changes in vehicle handling and braking.

If using winter tires:

- Use tires of the same brand and tread type on all four wheel positions.
- Use only radial ply tires of the same size, load range, and speed rating as the original equipment tires.

Winter tires with the same speed rating as the original equipment tires may not be available for H, V, W, Y, and ZR speed rated tires. If winter tires with a lower speed rating are chosen, never exceed the tire's maximum speed capability.

Tire Designations

Tire Size

The examples show a typical light truck tire size.

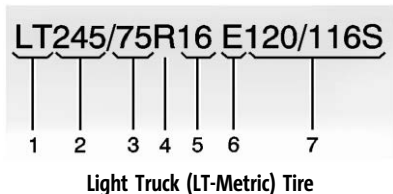

(1) Light Truck (LT-Metric) Tire : The United States version of a metric tire sizing system. The letters LT as the first two characters in the tire size mean a light truck tire engineered to standards set by the U.S. Tire and Rim Association.

(2) Tire Width : The 3-digit number indicates the tire section width in millimeters from sidewall to sidewall.

(3) Aspect Ratio : A 2-digit number that indicates the tire height-to-width measurements. For example, if the tire size aspect ratio is 75, as shown in

item (3) of the light truck (LT-Metric) tire illustration, it would mean that the tire's sidewall is 75 percent as high as it is wide.

(4) Construction Code : A letter code is used to indicate the type of ply construction in the tire. The letter R means radial ply construction; the letter D means diagonal or bias ply construction.

(5) Rim Diameter : Diameter of the wheel in inches.

(6) Load Range : Load Range.

(7) Service Description : The service description indicates the load index and speed rating of a tire. If two numbers are given as in the example, 120/116, then this represents the load index for single versus dual wheel usage (single/dual). The speed rating is the maximum speed a tire is certified to carry a load.

Tire Terminology and Definitions

Air Pressure : The amount of air inside the tire pressing outward on each square inch of the tire. Air pressure is expressed in kPa (kilopascal) or psi (pounds per square inch).

Aspect Ratio : The relationship of a tire's height to its width.

Belt : A rubber coated layer of cords that is located between the plies and the tread. Cords may be made from steel or other reinforcing materials.

Bead : The tire bead contains steel wires wrapped by steel cords that hold the tire onto the rim.

Bias Ply Tire : A pneumatic tire in which the plies are laid at alternate angles less than 90 degrees to the centerline of the tread.

Cold Tire Pressure : The amount of air pressure in a tire, measured in kPa (kilopascal) or psi (pounds per square inch) before a tire has built up heat from driving. See *Tire Pressure* ⇨ 194.

DOT Markings : A code molded into the sidewall of a tire signifying that the tire is in compliance with the U.S. Department of Transportation (DOT) Motor Vehicle Safety Standards. The DOT code includes the Tire Identification Number (TIN), an alphanumeric designator which can also identify the tire manufacturer, production plant, brand, and date of production.

GVWR : Gross Vehicle Weight Rating. See *Vehicle Load Limits* ⇨ 117.

GAWR FRT : Gross Axle Weight Rating for the front axle. See *Vehicle Load Limits* ⇨ 117.

GAWR RR : Gross Axle Weight Rating for the rear axle. See *Vehicle Load Limits* ⇨ 117.

Intended Outboard Sidewall : The side of an asymmetrical tire, that must always face outward when mounted on a vehicle.

Kilopascal (kPa) : The metric unit for air pressure.

Light Truck (LT-Metric) Tire : A tire used on light duty trucks and some multipurpose passenger vehicles.

Load Index : An assigned number ranging from 1 to 279 that corresponds to the load carrying capacity of a tire.

Maximum Inflation Pressure : The maximum air pressure to which a cold tire can be inflated. The maximum air pressure is molded onto the sidewall.

Maximum Load Rating : The load rating for a tire at the maximum permissible inflation pressure for that tire.

Occupant Distribution : Designated seating positions.

Outward Facing Sidewall : The side of an asymmetrical tire that has a particular side that faces outward when mounted on a vehicle. The side of the tire that contains a whitewall, bears white lettering, or bears manufacturer, brand, and/or model name molding that is higher or deeper than the same moldings on the other sidewall of the tire.

Passenger (P-Metric) Tire : A tire used on passenger cars and some light duty trucks and multipurpose vehicles.

Recommended Inflation Pressure : Vehicle manufacturer's recommended tire inflation pressure as shown on the tire placard. See *Tire Pressure* ⇨ 194 and *Vehicle Load Limits* ⇨ 117.

Radial Ply Tire : A pneumatic tire in which the ply cords that extend to the beads are laid at 90 degrees to the centerline of the tread.

Rim : A metal support for a tire and upon which the tire beads are seated.

Sidewall : The portion of a tire between the tread and the bead.

Speed Rating : An alphanumeric code assigned to a tire indicating the maximum speed at which a tire can operate.

Traction : The friction between the tire and the road surface. The amount of grip provided.

Tread : The portion of a tire that comes into contact with the road.

Treadwear Indicators : Narrow bands, sometimes called wear bars, that show across the tread of a tire when only 1.6 mm (1/16 in) of tread remains. See *When It Is Time for New Tires* ⇨ 200.

UTQGS (Uniform Tire Quality Grading Standards) : A tire information system that provides consumers with ratings for a tire's traction, temperature, and treadwear. Ratings are determined by tire manufacturers using government testing procedures. The ratings are molded into the sidewall of the tire. See *Uniform Tire Quality Grading* ⇨ 202.

Vehicle Capacity Weight : The number of designated seating positions multiplied by 68 kg (150 lbs) plus the rated cargo load. See *Vehicle Load Limits* ⇨ 117.

Vehicle Maximum Load on the Tire : Load on an individual tire due to curb weight, accessory weight, occupant weight, and cargo weight.

Vehicle Placard : A label permanently attached to a vehicle showing the vehicle's capacity weight and the

original equipment tire size and recommended inflation pressure. See "Tire and Loading Information Label" under *Vehicle Load Limits* ⇨ 117.

Tire Pressure

Tires need the correct amount of air pressure to operate effectively.

Warning

Neither tire underinflation nor overinflation is good. Underinflated tires, or tires that do not have enough air, can result in:

- Tire overloading and overheating, which could lead to a blowout
 - Premature or irregular wear
 - Poor handling
 - Reduced fuel economy for internal combustion engine vehicles
 - Reduced range for electric vehicles
- (Continued)

Warning (Continued)

Overinflated tires, or tires that have too much air, can result in:

- Unusual wear
- Poor handling
- Rough ride
- Needless damage from road hazards

The Tire and Loading Information label on the vehicle indicates the original equipment tires and the correct cold tire inflation pressures. The recommended pressure is the minimum air pressure needed to support the vehicle's maximum load carrying capacity.

For additional information regarding how much weight the vehicle can carry, and an example of the Tire and Loading Information label, see *Vehicle Load Limits* ⇨ 117. How the vehicle is loaded affects vehicle handling and ride

comfort. Never load the vehicle with more weight than it was designed to carry.

When to Check

Check the pressure of the tires once a month or more.

Do not forget the spare, if the vehicle has one. See *Full-Size Spare Tire* ⇨ 215 for additional information.

How to Check

Use a good quality pocket-type gauge to check tire pressure. Proper tire inflation cannot be determined by looking at the tire. Check the tire inflation pressure when the tires are cold, meaning the vehicle has not been driven for at least three hours or no more than 1.6 km (1 mi).

Remove the valve cap from the tire valve stem. Press the tire gauge firmly onto the valve to get a pressure measurement. If the cold tire inflation pressure matches the recommended pressure on the Tire and Loading Information label, no further adjustment

is necessary. If the inflation pressure is low, add air until the recommended pressure is reached. If the inflation pressure is high, press on the metal stem in the center of the tire valve to release air.

Re-check the tire pressure with the tire gauge.

Put the valve caps back on the valve stems to keep out dirt and moisture. Use only valve caps designed for the vehicle by GM. TPMS sensors could be damaged and would not be covered by the vehicle warranty.

Tire Pressure Monitor System

The Tire Pressure Monitor System (TPMS) uses radio and sensor technology to check tire pressure levels. The TPMS sensors monitor the air pressure in your tires and transmit tire pressure readings to a receiver located in the vehicle.

Each tire, including the spare (if provided), should be checked monthly when cold and inflated to the inflation pressure recommended by the vehicle manufacturer on the vehicle placard or tire inflation

pressure label. (If your vehicle has tires of a different size than the size indicated on the vehicle placard or tire inflation pressure label, you should determine the proper tire inflation pressure for those tires.)

As an added safety feature, your vehicle has been equipped with a tire pressure monitoring system (TPMS) that illuminates a low tire pressure telltale when one or more of your tires is significantly under-inflated.

Accordingly, when the low tire pressure telltale illuminates, you should stop and check your tires as soon as possible, and inflate them to the proper pressure. Driving on a significantly under-inflated tire causes the tire to overheat and can lead to tire failure. Under-inflation also reduces energy efficiency and tire tread life, and may affect the vehicle's handling and stopping ability.

Please note that the TPMS is not a substitute for proper tire maintenance, and it is the driver's responsibility to maintain correct tire pressure, even if under-inflation has not reached the level to trigger illumination of the TPMS low tire pressure telltale.

Your vehicle has also been equipped with a TPMS malfunction indicator to indicate when the system is not operating properly. The

TPMS malfunction indicator is combined with the low tire pressure telltale. When the system detects a malfunction, the telltale will flash for approximately one minute and then remain continuously illuminated. This sequence will continue upon subsequent vehicle start-ups as long as the malfunction exists.

When the malfunction indicator is illuminated, the system may not be able to detect or signal low tire pressure as intended. TPMS malfunctions may occur for a variety of reasons, including the installation of replacement or alternate tires or wheels on the vehicle that prevent the TPMS from functioning properly. Always check the TPMS malfunction telltale after replacing one or more tires or wheels on your vehicle to ensure that the replacement or alternate tires and wheels allow the TPMS to continue to function properly.

See *Tire Pressure Monitor Operation* ⇨ 196.

See *Radio Frequency Statement* ⇨ 237.

Tire Pressure Monitor Operation

This vehicle may have a Tire Pressure Monitor System (TPMS). The TPMS is designed to warn the driver when a low tire pressure condition exists. TPMS sensors are

mounted onto each tire and wheel assembly, excluding the spare tire and wheel assembly. The TPMS sensors monitor the air pressure in the tires and transmit the tire pressure readings to a receiver located in the vehicle.



When a low tire pressure condition is detected, the TPMS illuminates the low tire pressure warning light located on the instrument cluster. If the warning light comes on, stop as soon as possible and inflate the tires to the recommended pressure shown on the Tire and Loading Information label. See *Vehicle Load Limits* ⇨ 117.

A message to check the pressure in a specific tire displays in the Driver Information Center (DIC). The low tire pressure warning light and the DIC warning message come on each time the vehicle is turned on until the tires are inflated to the correct inflation pressure. If the vehicle has DIC buttons, tire pressure levels can be

viewed. For additional information and details about the DIC operation and displays, see *Driver Information Center (DIC)* ⇨ 72.

The low tire pressure warning light may come on in cool weather when the vehicle is first started, and then turn off as the vehicle is driven. This could be an early indicator that the air pressure is getting low and needs to be inflated to the proper pressure.

A Tire and Loading Information label shows the size of the original equipment tires and the correct inflation pressure for the tires when they are cold. See *Vehicle Load Limits* ⇨ 117, for an example of the Tire and Loading Information label and its location. Also see *Tire Pressure* ⇨ 194.

The TPMS can warn about a low tire pressure condition but it does not replace normal tire maintenance. See *Tire Inspection* ⇨ 198, *Tire Rotation* ⇨ 198, and *Tires* ⇨ 189.

Caution

Tire sealant materials are not all the same. A non-approved tire sealant could damage the TPMS sensors. TPMS sensor damage caused by using an incorrect tire sealant is not covered by the vehicle

(Continued)

Caution (Continued)

warranty. Always use only the GM approved tire sealant available through your dealer or included in the vehicle.

TPMS Malfunction Light and Message

The TPMS will not function properly if one or more of the TPMS sensors are missing or inoperable. When the system detects a malfunction, the low tire pressure warning light flashes for about one minute and then stays on for the remainder of the time the vehicle is on. A DIC warning message also displays. The malfunction light and DIC warning message will come on each time the vehicle is turned on until the problem is corrected. Some of the conditions that can cause these to come on are:

- One of the road tires has been replaced with the spare tire. The spare tire does not have a TPMS sensor. The malfunction light and the DIC message should go off after the road tire is replaced and the sensor matching process is performed successfully. See "TPMS Sensor Matching Process" later in this section.

- The TPMS sensor matching process was not done or not completed successfully after rotating the tires. The malfunction light and the DIC message should go off after successfully completing the sensor matching process. See "TPMS Sensor Matching Process" later in this section.
- One or more TPMS sensors are missing or damaged. The malfunction light and the DIC message should go off when the TPMS sensors are installed and the sensor matching process is performed successfully. See your dealer for service.
- Replacement tires or wheels do not match the original equipment tires or wheels. Tires and wheels other than those recommended could prevent the TPMS from functioning properly. See *Buying New Tires* ⇨ 200.
- Operating electronic devices or being near facilities using radio wave frequencies similar to the TPMS could cause the TPMS sensors to malfunction.

If the TPMS is not functioning properly, it cannot detect or signal a low tire pressure condition. See your dealer for service if the TPMS malfunction light and DIC message come on and stay on.

Tire Fill Alert (If Equipped)

This feature provides visual and audible alerts outside the vehicle to help when inflating an underinflated tire to the recommended cold tire pressure.

When the low tire pressure warning light comes on:

1. Park the vehicle in a safe, level place.
2. Set the parking brake firmly.
3. Place the vehicle in P (Park).
4. Add air to the tire that is underinflated. The turn signal lamp will flash.

When the recommended pressure is reached, the horn sounds once and the turn signal lamp will stop flashing and briefly turn solid.

Repeat these steps for all underinflated tires that have illuminated the low tire pressure warning light.

 Warning

Overinflating a tire could cause the tire to rupture and you or others could be injured. Do not exceed the maximum

(Continued)

Warning (Continued)

pressure listed on the tire sidewall. See *Tire Sidewall Labeling* ⇨ 191 and *Vehicle Load Limits* ⇨ 117.

If the tire is overinflated by more than 35 kPa (5 psi), the horn will sound multiple times and the turn signal lamp will continue to flash for several seconds after filling stops. To release and correct the pressure, while the turn signal lamp is still flashing, briefly press the center of the valve stem. When the recommended pressure is reached, the horn sounds once.

If the turn signal lamp does not flash within 15 seconds after starting to inflate the tire, the tire fill alert has not been activated or is not working.

If the hazard warning flashers are on, the tire fill alert visual feedback will not work properly.

The TPMS will not activate the tire fill alert properly under the following conditions:

- There is interference from an external device or transmitter.
- The air pressure from the inflation device is not sufficient to inflate the tire.

- There is a malfunction in the TPMS.
- There is a malfunction in the horn or turn signal lamps.
- The identification code of the TPMS sensor is not registered to the system.
- The battery of the TPMS sensor is low.

If the tire fill alert does not operate due to TPMS interference, move the vehicle about 1 m (3 ft) back or forward and try again. If the tire fill alert feature is not working, use a tire pressure gauge.

TPMS Sensor Matching Process — Auto Learn Function

Each TPMS sensor has a unique identification code. The identification code needs to be matched to a new tire/wheel position after rotating the tires or replacing one or more of the TPMS sensors. When a tire is installed, the vehicle must be stationary for about 20 minutes before the system recalculates. The following relearn process takes up to 10 minutes, driving at a minimum speed of 20 km/h (12 mph). A dash (-) or pressure value will display in the DIC. See *Driver Information Center (DIC)* ⇨ 72. A warning message displays in the DIC if a problem occurs during the relearn process.

Tire Inspection

We recommend that the tires, including the spare tire, if the vehicle has one, be inspected for signs of wear or damage at least once a month.

Replace the tire if:

- The indicators at three or more places around the tire can be seen.
- There is cord or fabric showing through the tire's rubber.
- The tread or sidewall is cracked, cut, or snagged deep enough to show cord or fabric.
- The tire has a bump, bulge, or split.
- The tire has a puncture, cut, or other damage that cannot be repaired well because of the size or location of the damage.

Tire Rotation

Tires should be rotated according to the interval specified in the Maintenance Schedule. See *Maintenance Schedule* ⇨ 229.

Tires are rotated to achieve a more uniform wear for all tires. The first rotation is the most important.

Anytime unusual wear is noticed, rotate the tires as soon as possible, check for proper tire inflation pressure, and check for damaged tires or wheels. If the unusual wear continues after the rotation, check the wheel alignment. See *When It Is Time for New Tires* ⇨ 200 and *Wheel Replacement* ⇨ 203.

If the full-size spare tire is part of the tire rotation, make sure the tire rotated into the spare position is stored securely. Push, pull, and then try to rotate or turn the tire. If it moves, use the wheel wrench/hoist shaft to tighten the cable. See *Tire Changing* ⇨ 205.

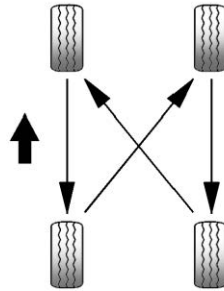

Use this rotation pattern when rotating the tires.

Adjust the front and rear tires to the recommended inflation pressure on the Tire and Loading Information label after the tires have been rotated. See *Tire Pressure* ⇨ 194 and *Vehicle Load Limits* ⇨ 117.

Reset the Tire Pressure Monitor System. See *Tire Pressure Monitor Operation* ⇨ 196.

Check that all wheel nuts are properly tightened. See “Wheel Nut Torque” under *Capacities and Specifications* ⇨ 236, and “Removing the Flat Tire and Installing the Spare Tire” under *Tire Changing* ⇨ 205.

Warning

Rust or dirt on a wheel, or on the parts to which it is fastened, can cause wheel nuts to become loose over time. The wheel could come off and cause a crash. When changing a wheel, remove any rust or dirt from places where the wheel attaches to the vehicle. In an emergency, a cloth or paper towel can be used; however, use a scraper or wire brush later to remove all rust or dirt.

Lightly coat the inner diameter of the wheel hub opening with wheel bearing grease after a wheel change or tire rotation to prevent corrosion or rust buildup.

⚠ Warning

Do not apply grease to the wheel mounting surface, wheel conical seats, or the wheel nuts or bolts. Grease applied to these areas could cause a wheel to become loose or come off, resulting in a crash.

When It Is Time for New Tires

Factors, such as maintenance, temperatures, driving speeds, vehicle loading, and road conditions affect the wear rate of the tires.

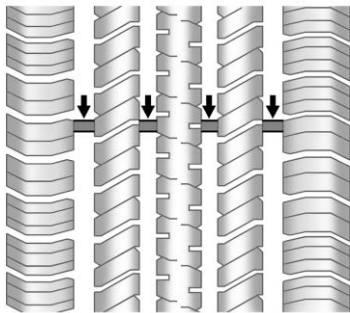

Treadwear indicators are one way to tell when it is time for new tires. Treadwear indicators appear when the tires have only

1.6 mm (1/16 in) or less of tread remaining. See *Tire Inspection* ⇨ 198 and *Tire Rotation* ⇨ 198.

The rubber in tires ages over time. This also applies to the spare tire, if the vehicle has one, even if it is never used. Multiple factors including temperatures, loading conditions, and inflation pressure maintenance affect how fast aging takes place. GM recommends that tires, including the spare if equipped, be replaced after six years, regardless of tread wear. To identify the age of a tire, use the tire manufacture date, which is the last four digits of the DOT Tire Identification Number (TIN) molded into one side of the tire sidewall. The last four digits of the TIN indicate the tire manufacture date. The first two digits represent the week and the last two digits, the year. For example, the third week of the year 2020 would have a 4-digit DOT date of 0320. Week 01 is the first full week (Sunday through Saturday) of each year.

Vehicle Storage

Tires age when stored normally mounted on a parked vehicle. Park a vehicle that will be stored for at least a month in a cool, dry, clean area away from direct sunlight to slow

aging. This area should be free of grease, gasoline, or other substances that can deteriorate rubber.

Parking for an extended period can cause flat spots on the tires that may result in vibrations while driving. When storing a vehicle for at least a month, remove the tires or raise the vehicle to reduce the weight from the tires.

Buying New Tires

GM has developed and matched specific tires for the vehicle. The original equipment tires installed were designed to meet General Motors Tire Performance Criteria Specification (TPC Spec) system rating. When replacement tires are needed, GM strongly recommends buying tires with the same TPC Spec rating.

GM's exclusive TPC Spec system considers over a dozen critical specifications that impact the overall performance of the vehicle, including brake system performance, ride and handling, traction control, and tire pressure monitoring performance.

GM's TPC Spec number is molded onto the tire's sidewall near the tire size. If the tires have an all-season tread design, the TPC Spec number will be followed by MS for mud and snow. See *Tire Sidewall Labeling* ⇨ 191 for additional information.

GM recommends replacing worn tires in complete sets of four (six for dual rear wheels). Uniform tread depth on all tires will help to maintain the performance of the vehicle. Braking and handling performance may be adversely affected if all the tires are not replaced at the same time. If proper rotation and maintenance have been done, all four tires (six for dual rear wheels) should wear out at about the same time. However, if it is necessary to replace only one axle set of worn tires, place the new tires on the rear axle (two for single rear wheels, four for dual rear wheels). See *Tire Rotation* ⇨ 198.

Warning

Tires could explode during improper service. Attempting to mount or dismount a tire could cause injury or death. Only your dealer or authorized tire service center should mount or dismount the tires.

Warning

Mixing tires of different sizes (other than those originally installed on the vehicle), brands, tread patterns, or types may cause loss of vehicle control, resulting in a crash or other vehicle damage. Use the correct size, brand, and type of tire on all wheels.

Warning

Using bias-ply tires on the vehicle may cause the wheel rim flanges to develop cracks after many miles of driving. A tire and/or wheel could fail
(Continued)

Warning (Continued)

suddenly and cause a crash. Use only radial-ply tires with the wheels on the vehicle.

Winter tires with the same speed rating as the original equipment tires may not be available for H, V, W, Y and ZR speed rated tires. Never exceed the winter tires' maximum speed capability when using winter tires with a lower speed rating.

If the vehicle tires must be replaced with a tire that does not have a TPC Spec number, make sure they are the same size, load range, speed rating, and construction (radial) as the original tires.

The Tire and Loading Information label indicates the original equipment tires on the vehicle. See *Vehicle Load Limits* ⇨ 117.

Different Size Tires and Wheels

If wheels or tires are installed that are a different size than the original equipment wheels and tires, vehicle performance, including its braking, ride and handling characteristics, stability, and resistance to rollover may be affected. If the vehicle has electronic systems such as antilock brakes, rollover airbags, traction control, electronic stability control, or All-Wheel Drive, the performance of these systems can also be affected.

Warning

If different sized wheels are used, there may not be an acceptable level of performance and safety if tires not recommended for those wheels are selected. This increases the chance of a crash and serious injury. Only use GM specific wheel and tire systems developed for the vehicle, and have them properly installed by a GM certified technician.

See *Buying New Tires* ⇨ 200 and *Accessories and Modifications* ⇨ 170.

Uniform Tire Quality Grading

The following information relates to the system developed by the United States National Highway Traffic Safety Administration (NHTSA), which grades tires by treadwear, traction, and temperature performance. This applies only to vehicles sold in the United States. The grades are molded on the sidewalls of most passenger car tires. The Uniform Tire Quality Grading (UTQG) system does not apply to deep tread, winter tires, compact spare tires, tires with nominal rim diameters of 10 to 12 inches (25 to 30 cm), or to some limited-production tires.

While the tires available on General Motors passenger cars and light trucks may vary with respect to these grades, they must also conform to federal safety requirements and additional General Motors Tire Performance Criteria (TPC) standards.

Quality grades can be found where applicable on the tire sidewall between tread shoulder and maximum section width. For example:

Treadwear 200 Traction AA Temperature A

All Passenger Car Tires Must Conform to Federal Safety Requirements In Addition To These Grades.

Treadwear

The treadwear grade is a comparative rating based on the wear rate of the tire when tested under controlled conditions on a specified government test course. For example, a tire graded 150 would wear one and one-half (1½) times as well on the government course as a tire graded 100. The relative performance of tires depends upon the actual conditions of their use, however, and may depart significantly from the norm due to variations in driving habits, service practices and differences in road characteristics and climate.

Traction

The traction grades, from highest to lowest, are AA, A, B, and C. Those grades represent the tire's ability to stop on wet pavement as measured under controlled conditions on specified government test surfaces of asphalt and concrete. A tire marked C may have poor traction performance. Warning: The traction grade assigned to this tire is based on straight-ahead braking traction tests, and does not include acceleration, cornering, hydroplaning, or peak traction characteristics.

Temperature

The temperature grades are A (the highest), B, and C, representing the tire's resistance to the generation of heat and its ability to dissipate heat when tested under controlled conditions on a specified indoor laboratory test wheel. Sustained high temperature can cause the material of the tire to degenerate and reduce tire life, and excessive temperature can lead to sudden tire failure. The grade C

corresponds to a level of performance which all passenger car tires must meet under the Federal Motor Safety Standard No. 109. Grades B and A represent higher levels of performance on the laboratory test wheel than the minimum required by law. Warning: The temperature grade for this tire is established for a tire that is properly inflated and not overloaded. Excessive speed, underinflation, or excessive loading, either separately or in combination, can cause heat buildup and possible tire failure.

Wheel Alignment and Tire Balance

The tires and wheels were aligned and balanced at the factory to provide the longest tire life and best overall performance. Adjustments to wheel alignment and tire balancing are not necessary on a regular basis. Consider an alignment check if there is unusual tire wear or the vehicle is significantly pulling to one side or the other. Some slight pull to the left or right, depending on the crown of the road and/or other road surface variations

such as troughs or ruts, is normal. If the vehicle is vibrating when driving on a smooth road, the tires and wheels may need to be rebalanced. See your dealer for proper diagnosis.

Wheel Replacement

Replace any wheel that is bent, cracked, or badly rusted or corroded. If wheel nuts keep coming loose, the wheel, wheel bolts, and wheel nuts should be replaced. If the wheel leaks air, replace it. Some aluminum wheels can be repaired. See your dealer if any of these conditions exist.

Your dealer will know the kind of wheel that is needed.

Each new wheel should have the same load-carrying capacity, diameter, width, offset, and be mounted the same way as the one it replaces.

Replace wheels, wheel bolts, wheel nuts, or Tire Pressure Monitor System (TPMS) sensors with new GM original equipment parts.

 **Warning**

Using the wrong replacement wheels, wheel bolts, or wheel nuts can be dangerous. It could affect the braking and handling of the vehicle. Tires can lose air and cause loss of control, resulting in a crash. Always use the correct wheel, wheel bolts, and wheel nuts for replacement.

 **Warning**

Replacing a wheel with a used one is dangerous. How it has been used or how far it has been driven may be unknown. It could fail suddenly and cause a crash. When replacing wheels, use a new GM original equipment wheel.

Caution

The wrong wheel can also cause problems with bearing life, brake cooling, speedometer or odometer calibration, headlamp aim, bumper height, vehicle ground clearance, and tire or tire chain clearance to the body and chassis.

Tire Chains**Caution**

If the vehicle is equipped with a tire size other than LT245/75R17, use tire chains only where legal and only when necessary. Use chains that are the proper size for the tires. Install them on the tires of the front axle. Do not use chains on the tires of the rear axle. Tighten them as tightly as possible with the ends securely fastened. Drive slowly and follow the chain manufacturer's instructions. If the chains contact the vehicle, stop and retighten them. If the contact continues, slow down until it stops. Driving too fast or spinning the wheels with chains on will damage the vehicle.

If a Tire Goes Flat

It is unusual for a tire to blow out while driving, especially if the tires are maintained properly. See *Tires* ⇨ 189. If air goes out of a tire, it is much more likely to leak out slowly. But if there is ever a blowout, here are a few tips about what to expect and what to do:

If a front tire fails, the flat tire creates a drag that pulls the vehicle toward that side. Take your foot off the accelerator pedal and grip the steering wheel firmly. Steer to maintain lane position, and then gently brake to a stop, well off the road, if possible.

A rear blowout, particularly on a curve, acts much like a skid and may require the same correction as used in a skid. Stop pressing the accelerator pedal and steer to straighten the vehicle. It may be very bumpy and noisy. Gently brake to a stop, well off the road, if possible.

 **Warning**

Driving on a flat tire will cause permanent damage to the tire. Re-inflating a tire after it has been driven on while severely underinflated or flat may cause a blowout and a serious crash. Never attempt to re-inflate a tire that has been driven on while severely underinflated or flat. Have your dealer or an authorized tire service center repair or replace the flat tire as soon as possible.

⚠ Warning

Lifting a vehicle and getting under it to do maintenance or repairs is dangerous without the appropriate safety equipment and training. If a jack is provided with the vehicle, it is designed only for changing a flat tire. If it is used for anything else, you or others could be badly injured or killed if the vehicle slips off the jack. If a jack is provided with the vehicle, only use it for changing a flat tire.

If a tire goes flat, avoid further tire and wheel damage by driving slowly to a level place, well off the road, if possible. Turn on the hazard warning flashers. See *Hazard Warning Flashers* ⇨ 79.

If your vehicle is loaded at or near maximum cargo capacity, it may be difficult to fit the jack under the vehicle due to the environment (shoulder slope, road debris, etc.). Removal of some weight may improve the ability to fit the jack under the vehicle at the correct jacking location.

⚠ Warning

Changing a tire can be dangerous. The vehicle can slip off the jack and roll over or fall causing injury or death. Find a level place to change the tire. To help prevent the vehicle from moving:

1. Set the parking brake firmly.
2. Put the vehicle in P (Park).
3. Turn the vehicle off and do not restart the vehicle while it is raised.
4. Do not allow passengers to remain in the vehicle.
5. Place wheel blocks, if equipped, on both sides of the tire at the opposite corner of the tire being changed.

When the vehicle has a flat tire (2), use the following example as a guide to assist in the placement of the wheel blocks (1), if equipped.

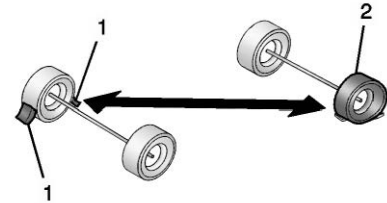

1. Wheel Block (If Equipped)
2. Flat Tire

The following information explains how to repair or change a tire.

Tire Changing**Removing the Spare Tire and Tools**

The tool kit may include a jack.

The kit is stored under the driver seat.

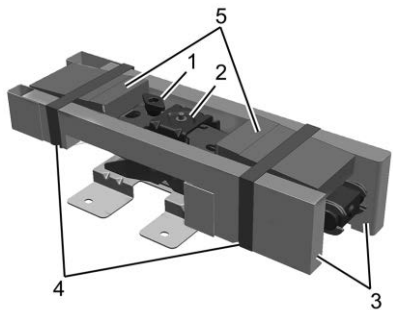

Tool Kit with Jack

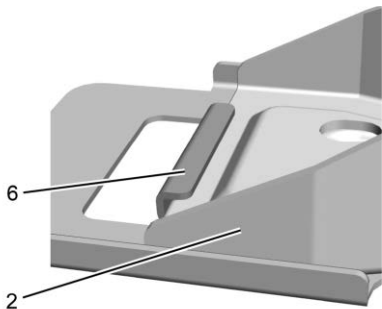

1. Jack Retention Bolt
2. Jack
3. Tool Kit

4. Tool Kit Retention Straps
 5. Wheel Blocks (If Equipped)
 6. Jack Bracket
1. Release the tool kit retention straps and remove the tool kit from the jack.
 2. Turn the jack retention bolt counterclockwise to remove the bolt.
 3. Remove the jack from the jack bracket by sliding it rearwards, then lifting it out of the bracket.

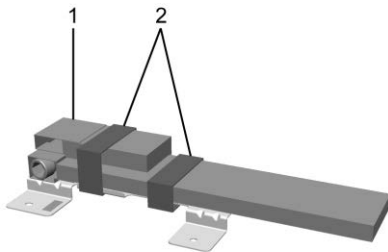

Tool Kit without Jack

1. Tool Kit
 2. Tool Kit Retention Straps
- Release the tool kit retention straps and remove the tool kit.

Use the jack handle extensions and the wheel wrench to remove the underbody-mounted spare tire.

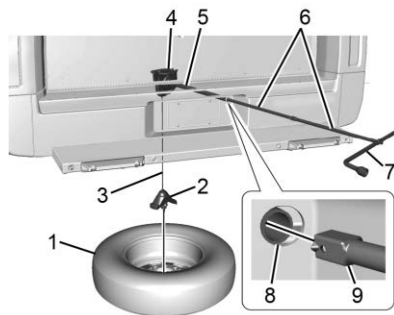

1. Spare Tire (Valve Stem Pointed Down)
2. Tire/Wheel Retainer
3. Hoist Cable
4. Hoist Assembly
5. Hoist Shaft
6. Jack Handle Extensions
7. Wheel Wrench
8. Hoist Shaft Access Hole
9. Hoist End of Extension Tool

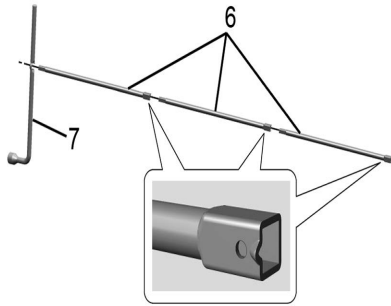

1. Assemble the wheel wrench (7) and the three jack handle extensions (6), as shown.



Spare Tire Cable If Equipped

2. If the vehicle is equipped with a spare tire cable disconnect the cable from the attachment on the frame by unclipping it from the frame attachment bracket.

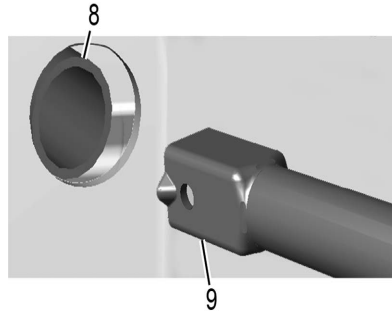

3. Insert the hoist end (open end) (9) of the extension through the hole (8) in the rear bumper.

Do not use the chiseled end of the wheel wrench.

Be sure the hoist end of the extension (9) connects to the hoist shaft. The ribbed square end of the extension is used to lower the spare tire.

4. Turn the wheel wrench counterclockwise to lower the spare tire to the ground. Continue to turn the wheel wrench until the spare tire can be pulled out from under the vehicle.
5. Pull the spare tire out from under the vehicle.



6. Tilt the tire toward the vehicle with some slack in the cable to access the tire/wheel retainer.

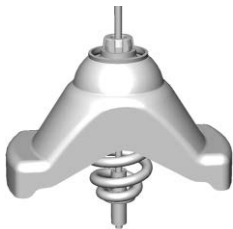

Tilt the retainer and pull it through the center of the wheel along with the cable and spring.

- Put the spare tire near the flat tire.



- If equipped with a spare tire cable remove the cable from the spare tire by passing the clip through the looped end of the cable.

Removing the Flat Tire and Installing the Spare Tire

Use the following pictures and instructions to remove the flat tire and raise the vehicle.

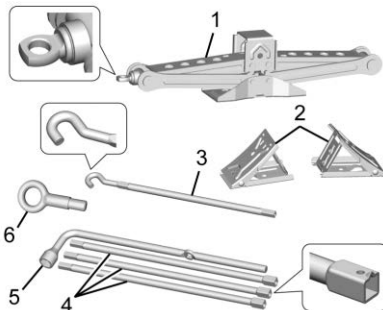

- Jack (If Equipped)
- Wheel Blocks (If Equipped)
- Jack Handle
- Jack Handle Extensions
- Wheel Wrench
- Tow Eye (If Equipped)

The tools you will be using include the jack (1) if equipped, the wheel blocks (2) if equipped, the jack handle (3), the jack handle extensions (4), and the wheel wrench (5).

- Do a safety check before proceeding. See *If a Tire Goes Flat* ⇨ 204.



- If the vehicle has a center cap with wheel nut caps, the wheel nut caps are designed to stay with the center cap after they are loosened. Remove the entire center cap.



3. Use the wheel wrench and turn it counterclockwise to loosen the wheel nuts. Do not remove the wheel nuts yet.

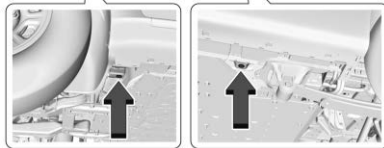
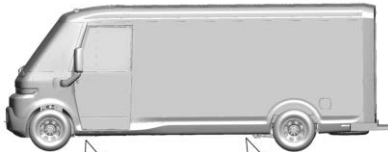

Caution

Make sure that the jack lift head is in the correct position or you may damage your vehicle. The repairs would not be covered by your warranty.

4. If the flat tire is on the front of the vehicle, position the jack under the front jacking pad, behind the front tire, as shown.
5. If the flat tire is on the rear of the vehicle, position the jack under the rear jacking pad, in front of the rear tire, as shown.

Warning

Getting under a vehicle when it is lifted on a jack is dangerous. If the vehicle slips off the jack, you could be badly injured or killed. Never get under a vehicle when it is supported only by a jack.

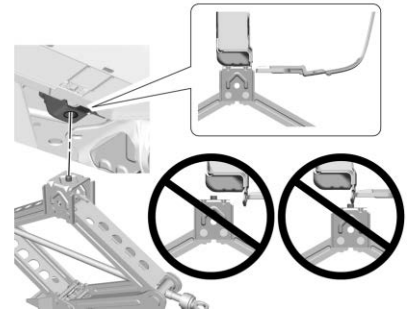

6. Ensure that the jack lift head is centered on the front or rear jacking pad. If equipped with a pin on the jack lift head, the pin must fit into the center of the hole in the jacking pad.

Warning

Raising the vehicle with the jack improperly positioned can damage the vehicle and even make the vehicle fall. To help avoid personal injury and vehicle damage, be sure to fit the jack lift head into the proper location before raising the vehicle.

7. Insert the hook end of the jack handle into the hole on the end of the jack. Assemble the wheel wrench to the jack handle. Turn the wheel wrench clockwise to raise the vehicle. Raise the vehicle far enough off the ground so there is enough room for the spare tire to fit under the wheel well.



8. Remove all the wheel nuts and take off the flat tire.

Warning

Rust or dirt on a wheel, or on the parts to which it is fastened, can cause wheel nuts to become loose

(Continued)

Warning (Continued)

over time. The wheel could come off and cause a crash. When changing a wheel, remove any rust or dirt from places where the wheel attaches to the vehicle. In an emergency, a cloth or paper towel can be used; however, use a scraper or wire brush later to remove all rust or dirt.

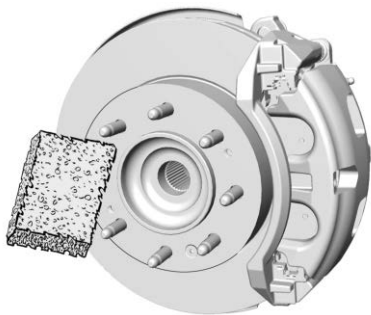

9. Remove any rust or dirt from the wheel bolts, mounting surfaces, and spare wheel.
10. Install the spare tire.

Warning

Never use oil or grease on bolts or nuts because the nuts might come loose. The vehicle's wheel could fall off, causing a crash.

11. Put the wheel nuts back on with the rounded end of the nuts toward the wheel.
12. Tighten each wheel nut by hand. Then use the wheel wrench to tighten the nuts until the wheel is held against the hub.
13. Turn the wheel wrench counterclockwise to lower the vehicle. Lower the jack completely.

Warning

If wheel studs are damaged, they can break. If all the studs on a wheel broke, the wheel could come off and cause a crash. If any stud is damaged because of a loose-running wheel, it could be that all of the studs are damaged. To be sure, replace all studs on the wheel. If the stud holes in a wheel have become larger, the

(Continued)

Warning (Continued)

wheel could collapse in operation. Replace any wheel if its stud holes have become larger or distorted in any way. Inspect hubs and hub-piloted wheels for damage. Because of loose running wheels, piloting pad damage may occur and require replacement of the entire hub, for proper centering of the wheels. When replacing studs, hubs, wheel nuts or wheels, be sure to use GM original equipment parts.

Warning

Wheel nuts that are improperly or incorrectly tightened can cause the wheels to become loose or come off. The wheel nuts should be tightened with a torque wrench to the proper torque specification after replacing. Follow the torque specification supplied by the aftermarket manufacturer when using accessory locking wheel nuts. See *Capacities and Specifications* ⇨ 236 for original equipment wheel nut torque specifications.

Caution

Improperly tightened wheel nuts can lead to brake pulsation and rotor damage. To avoid expensive brake repairs, evenly tighten the wheel nuts in the proper sequence and to the proper torque specification. See *Capacities and Specifications* ⇨ 236 for the wheel nut torque specification.

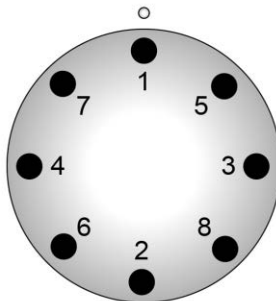

14. Tighten the nuts firmly in a crisscross sequence, as shown, by turning the wheel wrench clockwise.

When reinstalling the regular wheel and tire, also reinstall either the center cap, or bolt-on hub cap, depending on what the

vehicle is equipped with. For center caps, place the cap on the wheel and tap it into place until it seats flush with the wheel. The cap only goes on one way. Be sure to line up the tab on the center cap with the indentation on the wheel. For bolt-on hub caps, align the plastic nut caps with the wheel nuts and then tighten by hand. Then use the wheel wrench to tighten.

Storing a Flat or Spare Tire and Tools**Warning**

Storing a jack, a tire, or other equipment in the passenger compartment of the vehicle could cause injury. In a sudden stop or collision, loose equipment could strike someone. Store all these in the proper place.

Warning

Failure to follow these tire storage instructions carefully could result in personal injury or property damage if the hoist cable fails or if the tire comes loose. Make sure the tire is stored securely before driving.

Caution

Storing an aluminum wheel with a flat tire under your vehicle for an extended period of time or with the valve stem pointing up can damage the wheel. Always stow the wheel with the valve stem pointing down and have the wheel/tire repaired as soon as possible.

Caution

The tire hoist can be damaged if there is no tension on the cable when using it. To have the necessary tension, the spare or road tire and wheel assembly must be installed on the tire hoist to use it.

Warning

An improperly stored spare tire could come loose and cause a crash. To avoid personal injury or property damage, always store the spare tire when the vehicle is parked on a level surface.

Store the tire under the rear of the vehicle in the spare tire carrier.

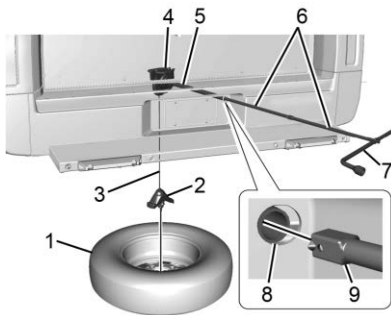

1. Spare Tire (Valve Stem Pointed Down)
2. Tire/Wheel Retainer
3. Hoist Cable
4. Hoist Assembly
5. Hoist Shaft
6. Jack Handle Extensions
7. Wheel Wrench
8. Hoist Shaft Access Hole
9. Hoist End of Extension Tool

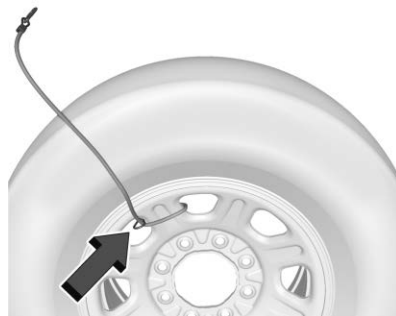

1. If equipped with a spare tire cable, reinstall the cable to the spare wheel by looping the cable around a wheel vent window then pass the clip end of the cable through the looped end. The excess cable wire should be on the valve stem side of the spare tire.
2. Put the tire on the ground at the rear of the vehicle with the valve stem pointed down, and to the rear.
3. Pull the cable and spring through the center of the wheel. Tilt the wheel retainer plate down and through the center wheel.
Make sure the retainer is fully seated across the underside of the wheel.

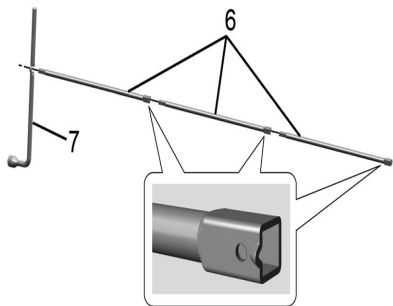

4. Attach the wheel wrench (7) and extensions (6) together, as shown.

Caution

Use of an air wrench or other power tools with the hoist mechanism is not recommended and could damage the system. Use only the tools supplied with the hoist mechanism.

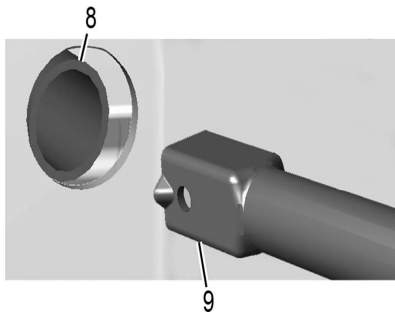

5. Insert the hoist end (9) through the hole (8) in the rear bumper and onto the hoist shaft.
- Do not use the chiseled end of the wheel wrench.
6. Raise the tire part way upward. Make sure the retainer is seated in the wheel opening.

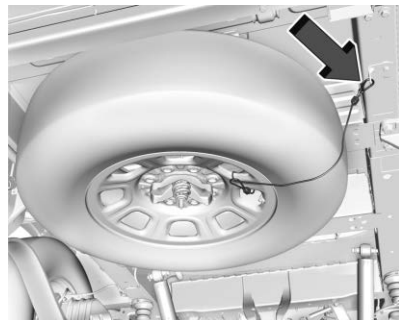

7. If equipped with a spare tire cable, orient the cable by rotating the spare tire so that the cable is by the frame attachment location. Do not reattach the clip to the frame attachment bracket in this step.
8. Raise the tire fully against the underside of the vehicle by turning the wheel wrench clockwise until you hear two clicks or feel it skip twice. You cannot overtighten the cable.

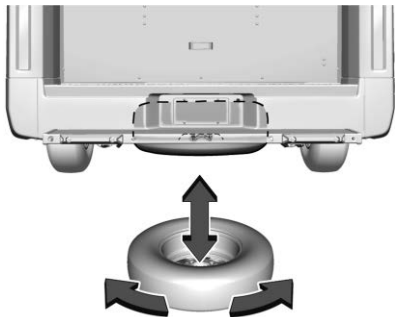

9. Make sure the tire is stored securely. Push, pull, and then try to turn the tire. If the tire moves, use the wheel wrench to tighten the cable.

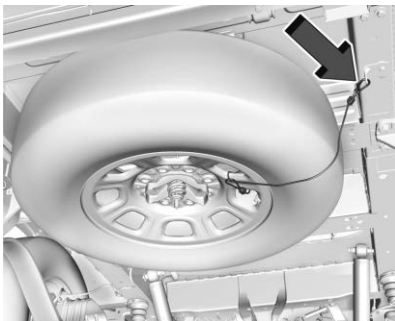

10. If equipped with a spare tire cable, reattach the clip to the frame attachment bracket. Note that there may be slack in the cable.

Repeat this tightness check procedure when checking the spare tire pressure according to the scheduled maintenance information or any time the spare tire is handled due to service of other components.



Correctly Stored



Incorrectly Stored

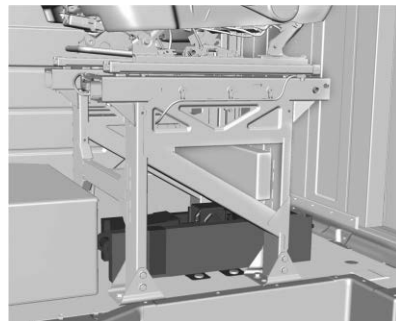

Tool Kit with Jack



Tool Kit without Jack

Return the jack (if equipped) and tools to their original storage location under the driver seat. See “Removing the Spare Tire and Tools.”

Full-Size Spare Tire

If this vehicle came with a full-size spare tire, it was fully inflated when new, however, it can lose air over time. Check the inflation pressure regularly. See *Tire Pressure* ⇨ 194 and

Vehicle Load Limits ⇨ 117 for information regarding proper tire inflation and loading the vehicle. For instructions on how to remove, install, or store a spare tire, see *Tire Changing* ⇨ 205.

After installing the spare tire on the vehicle, stop as soon as possible and check that the spare is correctly inflated. The spare tire is made to perform well at speeds up to 112 km/h (70 mph) at the recommended inflation pressure, so you can finish your trip.

Have the damaged or flat road tire repaired or replaced and installed back onto the vehicle as soon as possible so the spare tire will be available in case it is needed again. Do not mix tires and wheels of different sizes, because they will not fit. Keep the spare tire and its wheel together.

If this vehicle has a spare tire that does not match the vehicle’s original road tires and wheels, in size and type, do not include the spare in the tire rotation.

If equipped with a temporary use full-size spare tire, it is indicated on the tire sidewall. See *Tire Sidewall Labeling* ⇨ 191. This spare tire should not be driven on over 112 km/h (70 mph), or 88 km/h (55 mph) when pulling a trailer, at the proper inflation pressure. Repair and replace the road tire as soon as it is convenient, and stow the spare tire for future use.

Jump Starting

Jump Starting - North America

For more information about the vehicle battery, see *Battery - North America* ⇨ 177.

If the battery is discharged, use another vehicle and jumper cables to start your vehicle.

Warning

WARNING: Battery posts, terminals and related accessories can expose you to chemicals including lead and lead compounds, which are known to the State of California to cause cancer and birth defects or other reproductive harm. Wash hands after handling. For more information go to www.P65Warnings.ca.gov.

See the warning on the back cover.

⚠ Warning

Batteries can hurt you. They can be dangerous because:

- They contain acid that can burn you.
- They contain gas that can explode or ignite.
- They contain enough electricity to burn you.

Use eye protection when handling the battery. If you do not follow these steps exactly, some or all of these things can hurt you.

Caution

Ignoring these steps could result in costly damage to the vehicle that would not be covered by the vehicle warranty. Trying to start the vehicle by pushing or pulling it will not work, and it could damage the vehicle.

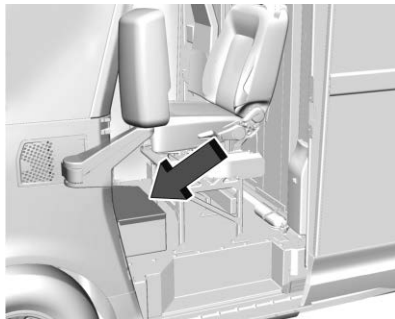

The battery is under a mat and cover in front of the driver seat on the floor.

Before connecting the cables, make sure positive (+) will go to the positive (+) terminal, and negative (-) will go to the negative (-) terminal on the battery providing the jump start to the negative grounding point for the discharged battery.

Caution

If the jumper cables are connected or removed in the wrong order, electrical shorting may occur and damage the vehicle. The repairs would not be covered by the vehicle warranty. Always connect

(Continued)

Caution (Continued)

and remove the jumper cables in the correct order, making sure that the cables do not touch each other or other metal.

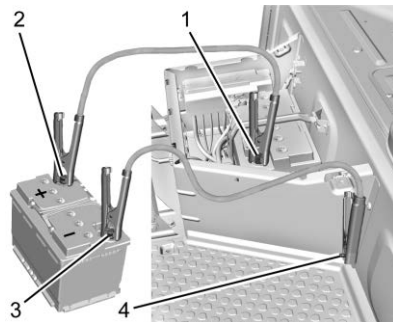

Connection Points and Sequence

1. Discharged Battery Positive (+) Terminal
 2. Good Battery Positive (+) Terminal
 3. Good Battery Negative (-) Terminal
 4. Discharged Battery Negative (-) Grounding Point
1. Check the other vehicle. It must have a 12-volt battery with a negative ground system.

Caution

If the other vehicle does not have a 12-volt system with a negative ground, both vehicles can be damaged. Only use a vehicle that has a 12-volt system with a negative ground for jump starting.

- Get the vehicles close enough so the jumper cables can reach, but make sure the vehicles are not touching each other. If they are, it could cause a ground connection you do not want. You would not be able to start the vehicle, and the bad grounding could damage the electrical systems.

To avoid the possibility of the vehicles rolling, set the parking brake firmly on both vehicles involved in the jump start procedure. Put the vehicles into P (Park). If the other vehicle has a manual transmission, put the vehicle into N (Neutral) before setting the parking brakes.

Caution

If any accessories are left on or plugged in during the jump starting procedure, they could be damaged. The repairs would not be covered by the vehicle warranty. Whenever possible, turn off or unplug all accessories on either vehicle when jump starting.

- Turn off both vehicles. Unplug unnecessary accessories plugged into the cigarette lighter or the accessory power outlet. Turn off the radio and all lamps that are not needed. This will avoid sparks and help save both batteries.
- To remove the floor mat, see *Floor Mats* ⇨ 227.

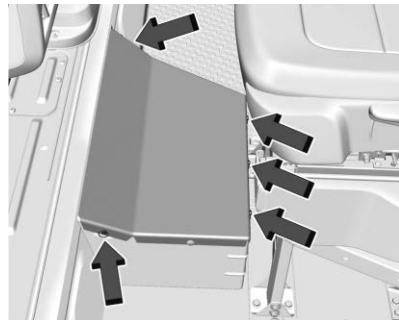

- Grab the each of the five hooks and lift to remove the cover to access.
- Locate the discharged battery positive (+) terminal and negative (-) grounding point.
- Check that the jumper cables do not have loose or missing insulation. If they do, you could get a shock. The vehicles could be damaged too.
- Open the positive terminal trim cover and connect the red positive (+) cable to the discharged battery positive (+) terminal.
Do not let the other end touch metal.
- Connect it to the positive (+) terminal of the good battery.

10. Now connect the black negative (-) cable to the negative (-) terminal of the good battery.
Do not let the other end touch anything until the next step.
11. Connect the other end of the negative (-) cable to the discharged battery negative (-) grounding point.
12. Now start the vehicle with the good battery and run the vehicle for a while.
13. Try to start the vehicle that had the discharged battery. If it will not start after a few tries, it probably needs service.

Jumper Cable Removal

Reverse the sequence exactly when removing the jumper cables.

After starting the disabled vehicle and removing the jumper cables, allow it to idle for several minutes.

After removing the jumper cables, install the access cover by turning the four bolts four quarters clockwise.

Towing the Vehicle

Transporting a Disabled Vehicle

Caution

Incorrectly transporting a disabled vehicle may cause damage to the vehicle. Use proper tire straps to secure the vehicle to the flatbed tow truck. Do not strap or hook to any frame, underbody, or suspension component not specified below. Do not move vehicles with drive axle tires on the ground. Damage is not covered by the vehicle warranty.

Caution

The vehicle may be equipped with an electric parking brake and/or an electronic shifter. In the event of a loss of 12-volt battery power, the electric parking brake cannot be released, and the vehicle cannot be shifted to N (Neutral). Tire skates or dollies must be used under the non-rolling tires to prevent damage while loading/unloading the vehicle. Dragging the vehicle will cause damage not covered by the vehicle warranty.

Caution

The vehicle may be equipped with a tow eye. Improper use of the tow eye may cause damage to the vehicle and is not covered by the vehicle warranty. If equipped, use the tow eye to load the vehicle onto a flatbed tow truck from a flat road surface, or to move the vehicle a very short distance at a walking pace. The tow eye is not designed for off-road recovery. The vehicle must be in N (Neutral) with the electric parking brake released when using the tow eye.

Contact a professional towing service if the disabled vehicle must be transported. GM recommends a flatbed tow truck to transport a disabled vehicle. Use ramps to help reduce approach angles, if necessary.

If equipped, a tow eye may be located near the spare tire or emergency jack. Do not use the tow eye to pull the vehicle from the snow, mud, sand, or ditch. Tow eye threads may have right or left-hand threads. Use caution when installing or removing the tow eye.

The vehicle must be in N (Neutral) and the electric parking brake must be released when loading the vehicle onto a flatbed tow truck.

- If the vehicle is equipped with car wash mode and has 12-volt battery power, refer to “Car Wash Mode” under *Electric Drive Unit* ⇨ 124 to place the vehicle in N (Neutral).
- If the 12-volt battery is dead and/or the vehicle will not start, the vehicle will not move. Try to jump start the vehicle. Refer to *Jump Starting - North America* ⇨ 215 and if the jump start is successful, retry the “Car Wash Mode” procedure.
- If jump starting is unsuccessful, the vehicle will not move. Tire skates or dollies must be used under the non-rolling tires to prevent vehicle damage.

Front Tow Eye Attachment Point

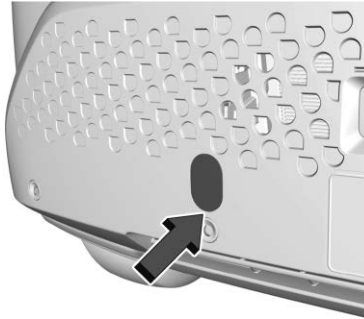

Carefully open the cover in the fascia by using the small notch that conceals the tow eye socket.



Install the tow eye into the socket and turn it until it is fully tightened. When the tow eye is removed, reinstall the cover with the notch in the original position.

Appearance Care

Exterior Care

Locks

Locks are lubricated at the factory. Use a de-icing agent only when absolutely necessary, and have the locks greased after using. See *Recommended Fluids and Lubricants* ⇨ 232.

Washing the Vehicle

To preserve the vehicle finish, wash it often and out of direct sunlight.

Warning

Do not power wash any part of the vehicle's interior, including the vinyl floor covering. This could damage safety and other systems in the vehicle, which would not be covered by the vehicle warranty.

Caution

Do not use petroleum-based, acidic, or abrasive cleaning agents as they can damage the vehicle's paint, metal, or plastic parts. If damage occurs, it would not be covered by the vehicle warranty. Approved cleaning products can be obtained from your dealer. Follow all manufacturer directions regarding correct product usage, necessary safety precautions, and appropriate disposal of any vehicle care product.

Caution

Avoid using high-pressure washes closer than 30 cm (12 in) to the surface of the vehicle. Use of power washers exceeding 8 274 kPa (1,200 psi) can result in damage or removal of paint and decals.

Cleaning Underhood Components

Caution

Do not power wash any component under the hood that has this  symbol.

This could cause damage that would not be covered by the vehicle warranty.

Solvents or aggressive cleaners may harm underhood components. The usages of these chemicals should be avoided.

Recommend water only.

A pressure washer may be used, but care must be utilized. The following criteria must be followed:

- Water pressure must be kept below 14 000 KPa (2,000 PSI).
- Water temperature must be below 80 °C (180 °F).

- Spray nozzle with a 40 degree wide angle spray pattern or wider must be used.
- Nozzle must be kept at least 30 cm (1 ft) away from all surfaces.

Automatic Car Wash

Caution

Some automatic car washes can cause damage to the vehicle, wheels and ground effects. Automatic car washes are not recommended, due to lack of clearance for the undercarriage and/or wide rear tires and wheels.

Caution

Automatic car washes can cause damage to the vehicle, wheels, ground effects, and convertible top (if equipped).

Do not use automatic car washes due to lack of clearance for the undercarriage, wide rear tires, and wheels.

If using an automatic car wash, follow with the car wash instructions. The windshield wiper and rear window wiper, if equipped,

must be turned off. Remove any accessories that may be damaged or interfere with the car wash equipment.

Rinse the vehicle well, before washing and after, to remove all cleaning agents completely. If they are allowed to dry on the surface, they could stain.

Dry the finish with a soft, clean chamois or an all-cotton towel to avoid surface scratches and water spotting.

Finish Care

Application of aftermarket clearcoat sealant/wax materials is not recommended. If painted surfaces are damaged, see your dealer to have the damage assessed and repaired. Foreign materials such as calcium chloride and other salts, ice melting agents, road oil and tar, tree sap, bird droppings, chemicals from industrial chimneys, etc., can damage the vehicle finish if they remain on painted surfaces. Wash the vehicle as soon as possible. If necessary, use non-abrasive cleaners that are marked safe for painted surfaces to remove foreign matter.

Occasional hand waxing or mild polishing should be done to remove residue from the paint finish. See your dealer for approved cleaning products.

Do not apply waxes or polishes to uncoated plastic, vinyl, rubber, decals, simulated wood, or flat paint as damage can occur.

Caution

Machine compounding or aggressive polishing on a basecoat/clearcoat paint finish may damage it. Use only non-abrasive waxes and polishes that are made for a basecoat/clearcoat paint finish on the vehicle.

To keep the paint finish looking new, keep the vehicle garaged or covered whenever possible.

Protecting Exterior Bright Metal Moldings

Caution

Failure to clean and protect the bright metal moldings can result in a hazy white finish or pitting. This damage would not be covered by the vehicle warranty.

The bright metal moldings on the vehicle are aluminum, chrome or stainless steel. To prevent damage always follow these cleaning instructions:

- Be sure the molding is cool to the touch before applying any cleaning solution.
- Use only approved cleaning solutions for aluminum, chrome or stainless steel. Some cleaners are highly acidic or contain alkaline substances and can damage the moldings.
- Always dilute a concentrated cleaner according to the manufacturer's instructions.
- Do not use cleaners that are not intended for automotive use.
- Use a nonabrasive wax on the vehicle after washing to protect and extend the molding finish.

Spray-In Bedliner Care

A spray-in bedliner is a permanent coating that bonds to the truck bed and cannot be removed. Promptly rinse the bedliner surface following a chemical spill to avoid permanent damage.

Spray-in bedliners can fade from oxidation, road dirt, heavy-duty hauling, and hard water stains. Clean it periodically by washing off the loose dirt and using a mild detergent. To restore the original appearance, apply the bedliner conditioner available through your dealer.

Caution

Using silicone-based products may damage the bedliner, reduce the slip-resistant texture, and attract dirt.

Cleaning Exterior Lamps/Lenses, Emblems, Decals and Stripes

Use only lukewarm or cold water, a soft cloth, and a car washing soap to clean exterior lamps, lenses, emblems, decals and stripes. Follow instructions under "Washing the Vehicle" previously in this section.

Lamp covers are made of plastic, and some have a UV protective coating. Do not clean or wipe them while they are dry.

Do not use any of the following on lamp covers:

- Abrasive or caustic agents.

- Washer fluids and other cleaning agents in higher concentrations than suggested by the manufacturer.
- Solvents, alcohols, or other harsh cleaners.
- Ice scrapers or other hard items.
- Aftermarket appearance caps or covers while the lamps are illuminated, due to excessive heat generated.

Caution

Failure to clean lamps properly can cause damage to the lamp cover that would not be covered by the vehicle warranty.

Caution

Using wax on low gloss black finish stripes can increase the gloss level and create a non-uniform finish. Clean low gloss stripes with soap and water only.

Air Intakes

Clear debris from the air intakes, between the hood and windshield, when washing the vehicle.

Shutter System

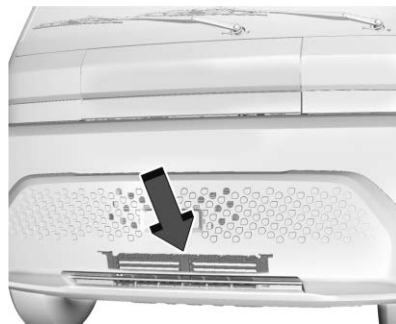

The vehicle may have a shutter system designed to help improve energy efficiency. Keep the shutter system clear of debris, snow and ice. If the check service vehicle soon light is activated, please check to see if the shutter system is clear of debris, snow or ice.

Windshield and Wiper Blades

Clean the outside of the windshield with glass cleaner.

Clean rubber blades using a lint-free cloth or paper towel soaked with windshield washer fluid or a mild detergent. Wash the windshield thoroughly when cleaning the

blades. Bugs, road grime, sap, and a buildup of vehicle wash/wax treatments may cause wiper streaking.

Replace the wiper blades if they are worn or damaged. Damage can be caused by extreme dusty conditions, sand, salt, heat, sun, snow, and ice.

Weatherstrips

Apply weatherstrip lubricant on weatherstrips to make them last longer, seal better, and not stick or squeak. Lubricate weatherstrips once a year. Hot, dry climates may require more frequent application. Black marks from rubber material on painted surfaces can be removed by rubbing with a clean cloth. See *Recommended Fluids and Lubricants* ⇨ 232.

Tires

Use a stiff brush with tire cleaner to clean the tires.

Caution
Using petroleum-based tire dressing products on the vehicle may damage the paint finish and/or tires. When applying a (Continued)

Caution (Continued)
tire dressing, always wipe off any overspray from all painted surfaces on the vehicle.

Wheels and Wheel Trim

Use a soft, clean cloth with mild soap and water to clean the wheels. After rinsing thoroughly with clean water, dry with a soft, clean towel. A wax may then be applied.

Caution
Chrome wheels and chrome wheel trim may be damaged if the vehicle is not washed after driving on roads that have been sprayed with magnesium chloride or calcium chloride. These are used on roads for conditions such as dust and ice. Always wash the chrome with soap and water after exposure.

Caution
To avoid surface damage on wheels and wheel trim, do not use strong soaps, chemicals, abrasive polishes, cleaners, (Continued)

Caution (Continued)
or brushes. Use only GM approved cleaners. Do not drive the vehicle through an automatic car wash that uses silicon carbide tire/wheel cleaning brushes. Damage could occur and the repairs would not be covered by the vehicle warranty.

Brake System

Visually inspect brake lines and hoses for proper hook-up, binding, leaks, cracks, chafing, etc. Inspect disc brake pads for wear and rotors for surface condition. Inspect drum brake linings/shoes for wear or cracks. Inspect all other brake parts.

Steering, Suspension, and Chassis Components

Visually inspect steering, suspension, and chassis components for damaged, loose, or missing parts or signs of wear at least once a year.

Inspect power steering for proper attachment, connections, binding, cracks, chafing, etc.

Visually check constant velocity joint boots and axle seals for leaks.

Caution

Lubrication of applicable suspension points should not be done unless the temperature is -12°C (10°F) or higher, or damage could result.

Body Component Lubrication

Lubricate all key lock cylinders, hood hinges, and the charge port door hinge unless the components are plastic. Applying silicone grease on weatherstrips with a clean cloth will make them last longer, seal better, and not stick or squeak.

Lubricate the rear door hinges, lock actuator, and counterbalance spring. Refer to the service manual for more information on proper lubrication.

Underbody Maintenance

At least twice a year, spring and fall, use plain water to flush any corrosive materials from the underbody. Take care to thoroughly clean any areas where mud and other debris can collect.

Sheet Metal Damage

If the vehicle is damaged and requires sheet metal repair or replacement, make sure the body repair shop applies anti-corrosion material to parts repaired or replaced to restore corrosion protection.

Original manufacturer replacement parts will provide the corrosion protection while maintaining the vehicle warranty.

Finish Damage

Quickly repair minor chips and scratches with touch-up materials available from your dealer to avoid corrosion. Larger areas of finish damage can be corrected in your dealer's body and paint shop.

Chemical Paint Spotting

Airborne pollutants can fall upon and attack painted vehicle surfaces causing blotchy, ring-shaped discolorations, and small, irregular dark spots etched into the paint surface. See "Finish Care" previously in this section.

Interior Care

To prevent dirt particle abrasions, regularly clean the vehicle's interior. Before using cleaners, read and follow all safety instructions on the label. While cleaning the interior, open the doors and windows to get proper ventilation. Newspapers or dark garments can transfer color to the vehicle's interior.

Caution

Immediately remove cleaners, hand lotions, sunscreen, and insect repellent from all interior surfaces or permanent damage may result.

Caution

Use cleaners specifically designed for the surfaces being cleaned to prevent permanent damage to the vehicle. Apply all cleaners directly to a cleaning cloth. Do not spray cleaners on any switches or controls.

When using liquid soap cleaners, follow the directions on the specific cleaner or soap solution for dilution instructions.

Caution

To prevent damage:

- Never use a razor or any other sharp object to remove soil from any interior surface
- Never use a brush with stiff bristles.
- Never rub any surface aggressively or with too much pressure.
- Do not get any exposed electrical components wet.
- Do not use laundry detergents or dishwashing soaps with degreasers. Do not use solutions that contain strong or caustic soap.
- Do not heavily saturate the upholstery when cleaning.
- Do not use solvents or cleaners containing solvents.
- Do not use disinfecting wipes that are scented or contain bleach. Do not use wipes or cleaners that show a color transfer to the wipe or change the appearance of the interior surface when used.

(Continued)

Caution (Continued)

- Do not use scented or gel-type hand sanitizers. If hand sanitizer comes in contact with interior surfaces of the vehicle, blot immediately and clean with a soft cloth dampened with a mild soap and water solution.

Interior Glass

To clean, use a microfiber cloth fabric dampened with water. Wipe droplets left behind with a clean dry cloth. If necessary, use a commercial glass cleaner after cleaning with plain water.

Caution

To prevent scratching, never use abrasive cleaners on automotive glass. Abrasive cleaners or aggressive cleaning may damage the rear window defogger.

Cleaning the windshield with water during the first three to six months of ownership will reduce tendency to fog.

Speaker Covers

Vacuum around a speaker cover gently, so that the speaker will not be damaged. Clean spots with water and mild soap.

Coated Moldings

Coated moldings should be cleaned.

- When lightly soiled, wipe with a sponge or soft, lint-free cloth dampened with water.
- When heavily soiled, use warm soapy water.

Vinyl/Rubber

If equipped with vinyl floor and rubber floor mats, use a soft cloth and/or brush dampened with water to remove dust and loose dirt. For more thorough cleaning, use a mild soap and water solution.

 **Warning**

Do not use cleaners that contain silicone, wax-based products, or cleaners that increase gloss on vinyl/rubber floor and mats. These cleaners can permanently change the appearance and feel of the vinyl/rubber and can make the floor slippery. Your foot could slip while operating the vehicle, and you could lose control, resulting in a crash. You or others could be injured.

Fabric/Carpet/Suede

Start by vacuuming the surface using a soft brush attachment. If a rotating vacuum brush attachment is being used, only use it on the floor carpet. Before cleaning, gently remove as much of the soil as possible:

- Gently blot liquids with a paper towel. Continue blotting until no more soil can be removed.
- For solid soils, remove as much as possible prior to vacuuming.

To clean:

1. Saturate a clean, lint-free colorfast cloth with water. Microfiber cloth is recommended to prevent lint transfer to the fabric or carpet.
2. Remove excess moisture by gently wringing until water does not drip from the cleaning cloth.
3. Start on the outside edge of the soil and gently rub toward the center. Fold the cleaning cloth to a clean area frequently to prevent forcing the soil into the fabric.
4. Continue gently rubbing the soiled area until there is no longer any color transfer from the soil to the cleaning cloth.

5. If the soil is not completely removed, use a mild soap solution followed only by plain water.

If the soil is not completely removed, it may be necessary to use a commercial upholstery cleaner or spot lifter. Test a small hidden area for colorfastness before using a commercial upholstery cleaner or spot lifter. If ring formation occurs, clean the entire fabric or carpet.

After cleaning, use a paper towel to blot excess moisture.

Cleaning High Gloss Surfaces and Vehicle Information and Radio Displays

Use a microfiber cloth on high gloss surfaces or vehicle displays. First, use a soft bristle brush to remove dirt that can scratch the surface. Then gently clean by rubbing with a microfiber cloth. Never use window cleaners or solvents. Periodically hand wash the microfiber cloth separately, using mild soap. Do not use bleach or fabric softener. Rinse thoroughly and air dry before next use.

Caution

Do not attach a device with a suction cup to the display. This may cause damage and would not be covered by the vehicle warranty.

Instrument Panel, Leather, Vinyl, Other Plastic Surfaces, Low Gloss Paint Surfaces, and Natural Open Pore Wood Surfaces

Use a soft bristle brush to remove dust from knobs and crevices on the instrument cluster. Use a soft microfiber cloth dampened with water to remove dust and loose dirt. For a more thorough cleaning, use a soft microfiber cloth dampened with a mild soap and water solution.

Caution

Soaking or saturating leather, especially perforated leather, as well as other interior surfaces, may cause permanent damage. Wipe excess moisture from these surfaces after cleaning and allow them to dry naturally. Never use heat, steam, or spot removers. Do not use liquids that contain alcohol or solvents on
(Continued)

Caution (Continued)

leather seats. Do not use cleaners that contain silicone or wax-based products. Cleaners containing these solvents can permanently change the appearance and feel of leather or soft trim, and are not recommended.

Do not use cleaners that increase gloss, especially on the instrument panel. Reflected glare can decrease visibility through the windshield under certain conditions.

Caution

Use of air fresheners may cause permanent damage to plastics and painted surfaces. If an air freshener comes in contact with any plastic or painted surface in the vehicle, blot immediately and clean with a soft cloth dampened with a mild soap solution. Damage caused by air fresheners would not be covered by the vehicle warranty.

Care of Seat Belts

Keep belts clean and dry.

Warning

Do not bleach or dye seat belt webbing. It may severely weaken the webbing. In a crash, they might not be able to provide adequate protection. Clean and rinse seat belt webbing only with mild soap and lukewarm water. Allow the webbing to dry.

Floor Mats**Warning**

If a floor mat is the wrong size or is not properly installed, it can interfere with the pedals. Interference with the pedals can cause unintended acceleration and/or increased stopping distance which can cause a crash and injury. Make sure the floor mat does not interfere with the pedals.

Use the following guidelines for proper floor mat use:

- The original equipment floor mats are designed for your vehicle. If the floor mats need to be replaced, it is recommended that GM-certified floor mats are purchased. Non-GM floor mats may not fit properly and may interfere with the pedals. Always check that the floor mats do not interfere with the pedals.
- Use the floor mat with the correct side up. Do not turn it over.
- Do not place anything on top of the driver side floor mat.
- Use only a single floor mat on the driver side.
- Do not place one floor mat on top of another.

Cleaning Rubber Floor Mats (All-Weather Mats and Floor Liners)

See “Vinyl/Rubber” under *Interior Care* ⇨ 224 for important cleaning information.

Service and Maintenance

General Information

General Information 228

Maintenance Schedule

Maintenance Schedule 229

Multi-Point Vehicle Inspection (MPVI)

Multi-Point Vehicle
Inspection (MPVI) 230

Owner Checks and Services

Owner Checks and Services 231

Recommended Fluids, Lubricants, and Parts

Recommended Fluids and Lubricants ... 232
Maintenance Replacement Parts 233

Maintenance Records

Maintenance Records 234

General Information

Your vehicle is an important investment. This section describes the required maintenance for the vehicle. Follow this schedule to help protect against major repair expenses resulting from neglect or inadequate maintenance. It may also help to maintain the value of the vehicle if it is sold. It is the responsibility of the owner to have all required maintenance performed.

Your dealer has trained technicians who can perform required maintenance using genuine replacement parts. They have up-to-date tools and equipment for fast and accurate diagnostics. Many dealers have extended evening and Saturday hours, courtesy transportation, and online scheduling to assist with service needs.

Your dealer recognizes the importance of providing competitively priced maintenance and repair services. With trained technicians, the dealer is the place for routine maintenance such as tire rotations and additional maintenance items like tires, brakes, batteries, and wiper blades.

Caution

Damage caused by improper maintenance can lead to costly repairs and may not be covered by the vehicle warranty. Maintenance intervals, checks, inspections, recommended fluids, and lubricants are important to keep the vehicle in good working condition.

Do not have chemical flushes that are not approved by GM performed on the vehicle. The use of flushes, solvents, cleaners, or lubricants that are not approved by GM could damage the vehicle, requiring expensive repairs that are not covered by the vehicle warranty.

The Tire Rotation and Required Services are the responsibility of the vehicle owner. It is recommended to have your dealer perform these services every 12 000 km/7,500 mi. Proper vehicle maintenance helps to keep the vehicle in good working condition.

The Additional Required Services are for vehicles that:

- Carry passengers and cargo within recommended limits on the Tire and Loading Information label. See *Vehicle Load Limits* ⇨ 117.

- Are driven on reasonable road surfaces within legal driving limits.

Warning

Performing maintenance work can be dangerous and can cause serious injury. Perform maintenance work only if the required information, proper tools, and equipment are available. If they are not, see your dealer to have a trained technician do the work. See *Doing Your Own Service Work* ⇨ 170.

Maintenance Schedule

Rotate Tires and Perform Required Services Every 12 000 km (7,500 mi)

Tires are rotated to achieve a more uniform wear for all tires. The first rotation is the most important.

Anytime unusual wear is noticed, rotate the tires as soon as possible, check for proper tire inflation pressure, and check for damaged tires or wheels. If the unusual wear continues after the rotation, check the wheel alignment. See *When It Is Time for New Tires* ⇨ 200 and *Wheel Replacement* ⇨ 203.

- Perform Multi-Point Vehicle Inspection. See *Multi-Point Vehicle Inspection (MPVI)* ⇨ 230.
- Lubricate body components. See *Exterior Care* ⇨ 219.

Additional Required Services

Every High Voltage Battery Charge

- Inspect the rear door latch striker plates for excessive wear or door movement. Make sure the rear door latch is flush to the striker on both sides of the vehicle. Adjust the strikers accordingly. If the latches or striker plates show excessive wear, refer to the service manual.

Every 36 000 km (22,500 mi)

- Passenger compartment air filter replacement (or every 24 months, whichever occurs first). More frequent replacement may be needed if the vehicle is driven in areas with heavy traffic, poor air quality, areas with high dust levels or are sensitive to environmental allergens. Filter replacement may also be needed if you notice reduced airflow, windows fogging up, or odors. Your local GM Service location can help you determine when it is the right time to replace your filter.

Every 72 000 km (45,000 mi)

- Replace exterior rear cargo door counterbalance springs. Or every three years, whichever comes first.

Every 161 000 km (100,000 mi)

- Replace hood and/or body lift support gas struts. Or every 10 years, whichever comes first.

Every 240 000 km (150,000 mi)

- Drain and fill vehicle coolant circuits. Or every five years, whichever comes first. See *Cooling System* ⇨ 175.

Severe Conditions Requiring More Frequent Maintenance*

- Public service, military, or commercial use vehicles to include the following:
 - Ambulances, police cars, and emergency rescue vehicles.
 - Civilian vehicles such as light duty pick-up trucks, SUVs, and passenger cars that are used in military applications.
 - Recovery vehicles such as tow trucks and flatbed single vehicle carriers or any vehicle that is consistently used in towing trailers or other loads.

- High use commercial vehicles such as courier delivery vehicles, private security patrol vehicles, or any vehicles that operate on a 24-hour basis.
- Any vehicle consistently operated in a high sand or dust environment such as those used on oil pipelines and similar applications.
- Vehicles that are regularly used for short trips of 6 km (4 mi) or less.

Additional Required Services — Severe Service

Every 48 000 km (30,000 mi)

- Replace exterior rear cargo door counterbalance springs. Or every two years, whichever comes first.

Owner Checks and Services

Every Five Years

- Replace brake fluid.

Every Seven Years

- Replace Air Conditioning Desiccant every seven years. The air conditioning system requires maintenance every seven years. This service requires replacement of the desiccant to help the longevity and

efficient operation of the air conditioning system. This service can be complex. See your dealer.

Multi-Point Vehicle Inspection (MPVI)

A Multi Point Vehicle Inspection (MPVI) completed by a GM dealer technician is a maintenance assessment of your vehicle. The benefit of the MPVI is to identify and inform the customer of service items that require immediate attention and those that may require attention in the future.

The technician will perform the following checks on your vehicle. For a complete list of checks, inspections, and services, see your dealer.

Some items may not apply to your vehicle and/or region.

Diagnostics

- OnStar active, if equipped
- Service history/recall check

Exterior Lights

- Visual inspection

Windshield and Wipers

- Visual inspection

Battery

- Battery visual inspection
- Battery test results
- Battery cables and connections

Systems, Fluids, and Visible Leak Inspection

- Electric Drive Unit
- Drive axle
- Transfer case
- Power electronics cooling system
- Windshield washer fluid

Tire Inspection

- Tire pressure, tread depth, and wear
- Rotation, if applicable
- Alignment check, optional
- Reset tire pressure monitor
- Check tire sealant expiration date, if equipped
- Check spare tire, if equipped

Brakes

- Check brake system

Visible and Functional Inspections

- Seat belt components
- Accelerator pedal
- Passenger compartment air filter, if equipped
- Hoses
- Shocks and struts
- Steering components
- Axle boots or driveshaft and u-joints
- Compartment lift struts, if equipped
- Floor mats secured, no interference with pedals
- Horn
- Starter switch

Lubricate

- Chassis components

Owner Checks and Services

- At least twice a year, have underbody flushing service performed. See "Underbody Maintenance" in *Exterior Care* ⇨ 219.
- Regularly check the rear door latch striker plates for wear and ensure they are clear of debris. Lubricate as necessary. Check the rear door lock actuator for proper function. If any functionality issues are found, see your dealer.

Recommended Fluids, Lubricants, and Parts

Recommended Fluids and Lubricants

Fluids and lubricants identified below by name or specification, including fluids or lubricants not listed here, can be obtained from your dealer.

Usage	Fluid/Lubricant
Electric Drive Unit	DEXRON ULV Automatic Transmission Fluid.
Hydraulic Brake System	GM approved DOT 4 Hydraulic Brake Fluid.
Key Lock Cylinders, Hood Hinges, Sliding Doors, and Door Latch Striker Plates/Pins	Multi-Purpose Lubricant, Superlube. See your dealer.
Vehicle Coolant Circuits	Use only ACDelco Premix (50/50 mixture of de-ionized water and DEX-COOL Coolant). See your dealer.
Windshield Washer	Automotive windshield washer fluid that meets regional freeze protection requirements.

Maintenance Replacement Parts

Replacement parts identified below by name, part number, or specification can be obtained from your dealer.

Part	GM Part Number	ACDelco Part Number
Passenger Compartment Air Filter	13508023	CF185
Wiper Blades		
Driver Side – 65 cm (25.6 in)	84983040	—
Passenger Side – 55 cm (21.6 in)	84225697	—

Technical Data

Vehicle Identification

Vehicle Identification Number (VIN) ... 235

Vehicle Data

Capacities and Specifications 236

Vehicle Identification

Vehicle Identification Number (VIN)



This legal identifier is in the front corner of the instrument panel, on the driver side of the vehicle. It can be seen through the windshield from outside. The Vehicle Identification Number (VIN) also appears on the Vehicle Certification label and certificates of title and registration.

Vehicle Data

Capacities and Specifications

The following approximate capacities are given in metric and English conversions.

Refer to *Recommended Fluids and Lubricants* ⇨ 232 for more information.

Application	Capacities	
	Metric	English
Air Conditioning Refrigerant	For the air conditioning system refrigerant charge type and amount, see the refrigerant label under the hood. See your dealer for more information.	
Total Cooling System*	18.0 L	19.0 qt
Wheel Nut Torque	190 N•m	140 lb ft
All capacities are approximate. When adding, be sure to fill to the approximate level, as recommended in this manual. Recheck fluid level after filling.		
*Cooling systems capacity values are based on the individual cooling system and its components. See your dealer.		

Customer Information

Customer Information

BrightDrop Service Operations and Support with Telecom Relay Services	237
Publication Ordering Information	237
Radio Frequency Statement	237

Reporting Safety Defects

Reporting Safety Defects to the United States Government	238
Reporting Safety Defects to the Canadian Government	238
Reporting Safety Defects to BrightDrop	238

Vehicle Data Recording and Privacy

Vehicle Data Recording and Privacy ...	239
Cybersecurity	239
Event Data Recorders	239
OnStar	239

Customer Information

BrightDrop Service Operations and Support with Telecom Relay Services

To assist the hearing or speech impaired, please contact our BrightDrop Service Operations and Support using the Telecommunication Relay Service by dialing 711.

BrightDrop Service Operations and Support: 1-888-987-4377.

Publication Ordering Information

Customer Literature

Owner's manuals are written specifically for owners and are intended to provide basic operational information about the vehicle. The owner's manual includes the Maintenance Schedule for all models.

Customer literature publications available for download include owner's manuals and any applicable supplements. You can download customer literature publications at <https://www.gobrightdrop.com/support>.

Radio Frequency Statement

This vehicle uses license-exempt transmitters / receivers / systems that operate on a radio frequency that complies with Part 15/Part 18 of the Federal Communications Commission (FCC) rules and

with Innovation, Science and Economic Development (ISED) Canada's license-exempt RSS(s) / RSP-100 / ICES-GEN.

Operation is subject to the following two conditions:

1. The device may not cause harmful interference.
2. The device must accept any interference received, including interference that may cause undesired operation of the device.

Changes or modifications to any of these systems by other than an authorized service facility could void authorization to use this equipment.

Reporting Safety Defects

Reporting Safety Defects to the United States Government

If you believe that your vehicle has a defect which could cause a crash or could cause injury or death, you should immediately inform the National Highway Traffic Safety Administration (NHTSA) in addition to notifying BrightDrop.

If NHTSA receives similar complaints, it may open an investigation, and if it finds that a safety defect exists in a group of vehicles, it may order a recall and remedy campaign. However, NHTSA cannot become involved in individual problems between you, your Service Agent, or BrightDrop.

To contact NHTSA, you may call the Vehicle Safety Hotline toll-free at 1-888-327-4236 (TTY: 1-800-424-9153); go to <https://www.safercar.gov>; or write to:

Administrator, NHTSA
1200 New Jersey Avenue, S.E.
Washington, D.C. 20590

You can also obtain other information about motor vehicle safety from <https://www.safercar.gov>.

Reporting Safety Defects to the Canadian Government

If you live in Canada, and you believe that the vehicle has a safety defect, notify Transport Canada immediately,

and notify General Motors of Canada Company. Call Transport Canada at 1-800-333-0510; go to:

www.tc.gc.ca/recalls (English)

www.tc.gc.ca/rappels (French)

or write to:

Transport Canada
Motor Vehicle Safety Directorate
Defect Investigations and Recalls
Division
80 Noel Street
Gatineau, QC J8Z 0A1

Reporting Safety Defects to BrightDrop

In addition to notifying NHTSA (or Transport Canada) in a situation like this, notify BrightDrop.

Call 1-888-987-4377, or write:

BrightDrop Service Operations and Support
29360 William Durant Blvd.
Warren, MI 48092

Vehicle Data Recording and Privacy

The vehicle has a number of computers that record information about the vehicle's performance and how it is driven or used. For example, the vehicle uses computer modules to monitor and control electric drive unit performance, to monitor the conditions for airbag deployment and to deploy them in a crash, and, if equipped, to provide antilock braking to help the driver control the vehicle. These modules may store data to help the dealer technician service the vehicle or to help BrightDrop improve safety or features. Some modules may also store data about how the vehicle is operated, such as rate of energy consumption or average speed. These modules may retain personal preferences, such as radio presets, seat positions, and temperature settings.

Cybersecurity

BrightDrop may collect information about the use of your vehicle including operational and safety related information. BrightDrop maintains appropriate security standards, practices, guidelines and controls aimed at

defending the vehicle and the vehicle service ecosystem against unauthorized electronic access. In the event you suspect any security incident impacting your data or the safe operation of your vehicle, please stop operating your vehicle and contact BrightDrop.

Event Data Recorders

This vehicle is equipped with an Event Data Recorder (EDR). The main purpose of an EDR is to record, in certain crash or near crash-like situations, such as an air bag deployment or hitting a road obstacle, data that will assist in understanding how a vehicle's systems performed. The EDR is designed to record data related to vehicle dynamics and safety systems for a short period of time, typically 30 seconds or less.

Note

EDR data are recorded by your vehicle only if a non-trivial crash situation occurs; no data are recorded by the EDR under normal driving conditions and no personal data (e.g., name, gender, age, and crash location) are recorded.

BrightDrop will collect, use, and disclose the data in accordance with the applicable privacy statement.

OnStar

If the vehicle is equipped with OnStar and has an active service plan, additional data may be collected and transmitted through the OnStar system. This includes information about the vehicle's operation; collisions involving the vehicle; the use of the vehicle and its features, including infotainment; and the location and approximate GPS speed of the vehicle. Refer to the OnStar Terms and Conditions and Privacy Statement on the OnStar website.

See *OnStar Additional Information* ⇨ 241.

OnStar

OnStar Overview

OnStar Overview 240

OnStar Services

Emergency 241

Security 241

OnStar Additional Information

OnStar Additional Information 241

OnStar Overview



 Voice Command Button

 Blue OnStar Button

 Red Emergency Button

This vehicle may be equipped with a comprehensive, in-vehicle system that can connect to an OnStar Advisor for Emergency and Security. OnStar services may require a paid service plan and data plan. OnStar requires the vehicle battery and electrical system, cellular service, and GPS satellite signals to be available and operating. OnStar acts as a link to existing emergency service providers. OnStar may collect information about you and your vehicle, including location information. See BrightDrop Terms & Conditions and Privacy Statement for more details at www.gobrightdrop.com (for U.S. and Canada).

The OnStar system status light is next to the OnStar buttons. If the status light is:

- Solid Green: System is ready.
- Flashing Green: On a call.
- Red: Indicates a problem.
- Off: System is off. Press  twice to speak with an OnStar Advisor.

Press  or call 1-888-4ONSTAR (1-888-466-7827) to speak to an Advisor.

Functionality of the Voice Command button may vary by vehicle and region.

Press  to answer or hang up an Advisor-initiated call.

Press  to connect to an Advisor to verify account information or update contact information.

Press  to get a priority connection to an OnStar Advisor available 24/7 to:

- Get help for an emergency.
- Be a Good Samaritan or respond to an AMBER Alert.
- Get assistance in severe weather or other crisis situations and find evacuation routes.

OnStar Services

Emergency

Emergency Services require an active fleet assurance package. With Automatic Crash Response, built-in sensors can automatically alert a specially trained OnStar Advisor who is immediately connected in to the vehicle to help.

Press **SOS** for a priority connection to an OnStar Advisor who can contact emergency service providers, direct them to your exact location, and relay important information.

With OnStar Crisis Assist, specially trained Advisors are available 24 hours a day, 7 days a week, to provide a central point of contact, assistance, and information during a crisis.

Security

If equipped, OnStar provides these services:

- With Stolen Vehicle Assistance, OnStar Advisors can use GPS to pinpoint the vehicle and help authorities quickly recover it.
- With Remote Ignition Block, if equipped, OnStar can block the vehicle from being restarted.

- With Stolen Vehicle Slowdown, if equipped, OnStar can work with law enforcement to gradually slow the vehicle down.

Theft Alarm Notification

If equipped, if the doors are locked and the vehicle alarm sounds, a notification by text, e-mail, or phone call will be sent. If the vehicle is stolen, an OnStar Advisor can work with authorities to recover the vehicle.

OnStar Additional Information

In-Vehicle Audio Messages

Audio messages may play important information at the following times:

- Prior to vehicle purchase. Press **On** to set up an account.
- After change in ownership and at 90 days.

Transferring Service

Press **On** to request account transfer eligibility information. The Advisor can cancel or change account information.

Selling/Transferring the Vehicle

Call 1-888-4ONSTAR (1-888-466-7827) immediately to terminate your OnStar or connected services if the vehicle is disposed of, sold, transferred, or if the lease ends.

Reactivation for Subsequent Owners

Press **On** and follow the prompts to speak to an Advisor as soon as possible. The Advisor will update vehicle records and explain OnStar or connected service options.

How OnStar Service Works

Automatic Crash Response, Emergency Services, Crisis Assist, Stolen Vehicle Assistance, Remote Services, and Roadside Assistance are available on most vehicles. Not all OnStar services are available everywhere or on all vehicles. For more information, a full description of OnStar services, system limitations, and OnStar User Terms, Privacy Statement, and Software Terms:

- Call 1-888-4ONSTAR (1-888-466-7827).
- See www.onstar.com (U.S.).
- See www.onstar.ca (Canada).
- Call TTY 1-877-248-2080.
- Press **On** to speak with an Advisor.

OnStar or connected services cannot work unless the vehicle is in a place where OnStar has an agreement with a wireless service provider for service in that area. The wireless service provider must also have coverage, network capacity, reception, and technology compatible with OnStar or connected services. Service involving location information about the vehicle cannot work unless GPS signals are available, unobstructed, and compatible with the OnStar hardware. OnStar or connected services may not work if the OnStar equipment is not properly installed or it has not been properly maintained. If equipment or software is added, connected, or modified, OnStar or connected services may not work. Other problems beyond the control of OnStar — such as hills, tall buildings, tunnels, weather, electrical system design and architecture of the vehicle, damage to the vehicle in a crash, or wireless phone network congestion or jamming — may prevent service.

See *Radio Frequency Statement* ⇨ 237.

Services for People with Disabilities

Advisors provide services to help with physical disabilities and medical conditions.

Press  to help:

- Find a hotel, restaurant, etc., that meets accessibility needs.
- Provide directions to the closest hospital or pharmacy in urgent situations.

TTY Users

OnStar has the ability to communicate to deaf, hard-of-hearing, or speech-impaired customers while in the vehicle. The available TTY system provides in-vehicle access to all OnStar services, except Virtual Advisor and OnStar Turn-by-Turn Navigation.

If equipped, access TTY by touching Settings > System> TTY from the infotainment home screen. When TTY mode is active, you can make and receive phone calls using the infotainment display.

Warranty

OnStar equipment may be warranted as part of the vehicle warranty.

Languages

The vehicle can be programmed to respond in multiple languages. Press  and ask for an Advisor. Advisors are available in English, Spanish, and French. Available languages may vary by country.

Potential Issues

OnStar cannot perform Remote Door Unlock or Stolen Vehicle Assistance after the vehicle has been off continuously for an extended period of time without being started. To find out the duration of time that applies for the vehicle, contact an OnStar Advisor by pressing  or calling 1-888-4ONSTAR. If the vehicle has not been started for an extended period of time, OnStar can contact Roadside Assistance or a locksmith to help gain access to the vehicle.

Global Positioning System (GPS)

- Obstruction of the GPS can occur in a large city with tall buildings; in parking garages; around airports; in tunnels and underpasses; or in an area with very dense trees. If GPS signals are not available, the OnStar system should still operate to call OnStar. However, OnStar could have difficulty identifying the exact location.
- In emergency situations, OnStar can use the last stored GPS location to send to emergency responders.

Cellular and GPS Antennas

Cellular reception is required for OnStar to send remote signals to the vehicle. Do not place items over or near the antenna to prevent blocking cellular and GPS signal reception.

Unable to Connect to OnStar Message

If there is limited cellular coverage or the cellular network has reached maximum capacity, this message may come on. Press  to try the call again or try again after driving a few miles into another cellular area.

Vehicle and Power Issues

OnStar services require a vehicle electrical system, wireless service, and GPS satellite technologies to be available and operating for features to function properly. These systems may not operate if the battery is discharged or disconnected.

Add-on Electrical Equipment

The OnStar system is integrated into the electrical architecture of the vehicle. Do not add any electrical equipment. See *Add-On Electrical Equipment* ⇨ 168. Added electrical equipment may interfere with the operation of the OnStar system and cause it to not operate.

Vehicle Software Updates

OnStar or BrightDrop may remotely deliver software updates or changes to the vehicle without further notice or consent. These updates or changes may enhance or maintain safety, security, or the operation of the vehicle or the vehicle systems. Software updates or changes may affect or erase data or settings that are stored in the vehicle, such as saved navigation destinations or pre-set radio stations. Neither OnStar nor BrightDrop is responsible for any affected or erased data or settings.

These updates or changes may also collect personal information. Such collection is described in the OnStar privacy statement or separately disclosed at the time of installation. These updates or changes may also cause a system to automatically communicate with BrightDrop servers to collect information about vehicle system status, identify whether updates or changes are available, or deliver updates or changes. An active OnStar or BrightDrop connected services agreement constitutes consent to these software updates or changes and agreement that either OnStar or BrightDrop may remotely deliver them to the vehicle.

Privacy

The complete BrightDrop Terms & Conditions and Privacy Statement may be found at www.gobrightdrop.com. We recommend that you review it. If you have any questions, call 1-888-4ONSTAR (1-888-466-7827) or press  to speak with an Advisor. Users of wireless communications are cautioned that the privacy of any information sent via wireless cellular communications cannot be assured. Third parties may unlawfully intercept or access transmissions and private communications without consent.

OnStar – Software Acknowledgements

To obtain the source code under GPL, LGPL, MPL, and other open source licenses, that is contained in this product, please visit <https://opensource.lge.com>. In addition to the source code, all referred license terms, warranty disclaimers, and copyright notices are available for download. This offer is valid for a period of three years after our last shipment of this product. This offer is valid to anyone in receipt of this information.

*Provided through LG Electronics Inc., who is solely responsible for provisions of related OSS compliance.

Index

A	
Accessories and Modifications	170
Accessory Power	122
Adaptive	
Cruise Control	134
Add-On Electrical Equipment	168
Additional	
OnStar Information	241
Agreements	
Trademarks and License	102
Air	
Conditioning	105
Filter, Passenger Compartment	108
Vents	107
Airbag System	36
Check	41
How Does an Airbag Restrain?	39
What Makes an Airbag Inflate?	39
What Will You See after an Airbag Inflates?	40
When Should an Airbag Inflate?	38
Where Are the Airbags?	37
Airbags	
Adding Equipment to the Vehicle	41
Readiness Light	59
Replacing System Parts after a Crash	42
Servicing Airbag-Equipped Vehicles	41
Alarm	
Vehicle Security	20
Alert	
Lane Change	156
Rear Cross Traffic	150
Side Blind Zone (SBZA)	156
All-Season Tires	190
All-Wheel Drive	128
Light	62
AM-FM Radio	87
Antenna	
Multi-band	89
Antilock Brake System (ABS)	128
Warning Light	62
Appearance Care	
Exterior	219
Interior	224
Apple CarPlay and Android Auto	99
Assistance Systems	
Driving	151
Audio	
Bluetooth	89
Automatic	
Climate Control System	105
Door Locks	15
Emergency Braking (AEB)	153
Emergency Braking (AEB) Disabled Light	63

Automatic (cont'd)		Brakes (cont'd)		Cargo	
Headlamp System	78	Regenerative Braking	131	Area	47
Vehicle Hold Light	62	Braking	112	Tie-Downs	48
Automatic Vehicle Hold (AVH)	130	Automatic Emergency (AEB)	153	Cargo Lamps	80
Avoiding Untrusted Media Devices	89	Reverse Automatic	149	Caution, Danger, and Warning	2
B		Braking System		Chains, Tire	204
Battery		Front Pedestrian (FPB)	154	Charge Cord Connected Light	60
Charging Electrical Requirements	168	Break-In, New Vehicle	120	Charging	66
Exterior Lighting Battery Saver	82	BrightDrop		Delay Override	164
Fault Light	60	Service Operations and Support		Plug-In	160
Gauge	58	with Telecom Relay Services	237	Status Feedback	165
Load Management	81	Buckle To Drive	30	System Light	60
Power Protection	82	Bulb Replacement	181	Utility Interruption	167
Battery - North America	177, 215	Headlamp Aiming	181	Child Restraints	
Blade Replacement, Wiper	180	Buying New Tires	200	Infants and Young Children	44
Blind		C		Older Children	42
Zone Steering Assist (BZSA)	158	California		Circuit Breakers	183
Bluetooth		Perchlorate Materials Requirements ...	170	Cleaning	
Audio	89	California Proposition 65 Warning	1, 215	Exterior Care	219
Overview	95, 96	Camera		Interior Care	224
Brake		Rear Vision (RVC)	145	Climate Control Systems	
Fluid	177	Canadian Vehicle Owners	2	Automatic	105
System Warning Light	61	Capacities and Specifications	236	Clock	54
Brakes	176	Car Wash Mode	124	Cluster, Instrument	55
Antilock	128	Carbon Monoxide		Compartment	
Brake Assist	130	Winter Driving	115	Underhood	174
Electric Parking Brake	129			Compartments	
				Storage	46

Console		Destination	91	Driving (cont'd)	
Overhead	47	Disabled Vehicle		Off-Road Recovery	113
Control		Transporting	218	One-Pedal	127
Traction and Electronic Stability	131	Distracted Driving	111	Vehicle Load Limits	117
Control of a Vehicle	112	Dome Lamps	80	Wet Roads	114
Controls		Door		Winter	115
Steering Wheel	85	Ajar Light	66	Driving for Better Energy Efficiency	110
Convex Mirrors	22	Delayed Locking	15		
Cooling	105	Locks	13	E	
Cooling System	175	Power Locks	14	Electric	
Cruise Control	133	Rear Doors	17	Drive Unit	124
Adaptive	134	Sliding	16	Parking Brake	129
Light	65	Drive Systems		Parking Brake Light	61
Cupholders	47	All-Wheel Drive	128	Electrical	
Customer Information		Drive Unit		Equipment, Add-On	168
Publications Ordering Information	237	Electric	124	Requirements for Battery Charging	168
Cybersecurity	239	Driver		System Overload	182
D		Assistance Systems	144	Electrical System	
Danger, Warning, and Caution	2	Information Center (DIC)	72	Fuses and Circuit Breakers	183
Dashboard	4	Mode Control	132	Instrument Panel Fuse Block	187
Data Collection		Driving		Emergency	
OnStar	239	Assistance Systems	151	OnStar	241
Data Recorders, Event	239	Defensive	111	Energy Efficiency	
Daytime Running Lamps (DRL)	77	Distracted	111	Driving	110
Defensive Driving	111	Hill and Mountain Roads	115	Energy Information	72
Delayed Charging Override	164	If the Vehicle is Stuck	116	Engine	
Delayed Locking	15	Impaired	112	Cooling System	175
		Loss of Control	113	Entry Lighting	81

- Event Data Recorders 239
- Exit Lighting 81
- Extended Parking 124
- Extender, Seat Belt 35
- Exterior
- Cargo Lamps 79
 - Lamp Controls 76
 - Lighting Battery Saver 82
- F**
- Fire Extinguisher 48
- First Aid Kit 49
- Flash-to-Pass 77
- Flashers, Hazard Warning 79
- Flat Tire 204
- Changing 205
- Floor Mats 227
- Fluid
- Brakes 177
 - Washer 175
- Folding Mirrors 23
- Forward
- Collision Alert (FCA) System 151
- Frequency Statement
- Radio 237
- Front
- Heated Seats 28
 - Pedestrian Braking (FPB) System 154
- Front Seats
- Adjustment 26
- Full-Size Spare Tire 215
- Fuses
- Fuses and Circuit Breakers 183
 - Instrument Panel Fuse Block 187
 - Underhood Compartment 183
- G**
- Gauges
- Battery 58
 - Odometer 58
 - Power Indicator 59
 - Speedometer 58
 - Trip Odometer 58
 - Warning Lights and Indicators 55
- General Information
- Service and Maintenance 228
 - Towing 168
 - Vehicle Care 170
- Global Positioning System (GPS) 92
- Guidance
- Problems with the Route 93
- H**
- Hazard Warning Flashers 79
- Head Restraints 25
- Headlamps
- Aiming 181
- Headlamps (cont'd)
- Automatic 78
 - Bulb Replacement 181
 - Daytime Running Lamps (DRL) 77
 - Flash-to-Pass 77
 - High-Beam On Light 65
 - High/Low Beam Changer 77
 - Lamps On Reminder 65
- Heated
- Front Seats 28
 - Mirrors 23
 - Steering Wheel 51
- Heating 105
- High Voltage Battery Gauge 58
- High Voltage Devices and Wiring 181
- High-Beam On Light 65
- Hill and Mountain Roads 115
- Hill Start Assist (HSA) 130
- Hood 171
- Horn 51
- How to Wear Seat Belts Properly 30
- HVAC 105
- I**
- Immobilizer 21
- Indicator
- Pedestrian Ahead 63
 - Vehicle Ahead 63

Indicators
 Warning Lights and Gauges 55
 Infants and Young Children, Restraints 44
 Information
 Energy 72
 Publication Ordering 237
 Infotainment
 Using the System 85
 Inspection
 Multi-Point Vehicle 230
 Instrument Cluster55
 Instrument Panel
 Storage Area 46
 Instrument Panel Overview 4
 Introduction2, 83
J
 Jump
 Seat 29
 Starting - North America 215
K
 Keys 6
 Remote 7
 Remote Operation 7

L
 Labeling, Tire Sidewall191
 Lamps
 Cargo 80
 Daytime Running (DRL) 77
 Dome 80
 Exterior Cargo 79
 Exterior Controls 76
 Exterior Lighting Battery Saver 82
 Flash-to-Pass 77
 High/Low Beam Changer 77
 On Reminder 65
 Lane
 Change Alert (LCA) 156
 Keep Assist (LKA) 158
 Keep Assist Light 62
 Lap-Shoulder Belt32
 LED Lighting181
 Lighting
 Entry 81
 Exit 81
 Illumination Control 80
 LED181
 Lights
 Airbag Readiness 59
 All-Wheel-Drive 62
 Antilock Brake System (ABS)
 Warning 62

Lights (cont'd)
 Automatic Emergency Braking (AEB)
 Disabled 63
 Automatic Vehicle Hold 62
 Battery Fault 60
 Brake System Warning 61
 Charge Cord Connected 60
 Charging System 60
 Cruise Control Light 65
 Door Ajar 66
 Electric Parking Brake 61
 Gauges and Indicators 55
 High-Beam On 65
 Lane Keep Assist 62
 Low State of Charge 60
 Seat Belt Reminders 59
 Security65
 Service Electric Parking Brake 61
 Service Vehicle Soon 61
 StabiliTrak OFF 64
 Tire Pressure 64
 Traction Control System
 (TCS)/StabiliTrak 64
 Traction Off 63
 Vehicle Ready 65
 Lock
 Steering Column 21

Locks			
Automatic Door	15		
Delayed Locking	15		
Door	13		
Lockout Protection	15		
Power Door	14		
Loss of Control	113		
Low State of Charge Light	60		
M			
Maintenance			
Records	234		
Maintenance Schedule	229		
Recommended Fluids and Lubricants	232		
Maps	91		
Media			
Avoiding Untrusted Devices	89		
Messages			
Propulsion Power	74		
Vehicle	74		
Vehicle Speed	75		
Mirrors			
Convex	22		
Folding	23		
Heated	23		
Power	22		
Mode			
Car Wash	124		
Driver Control	132		
Monitor System, Tire Pressure	195		
Multi-band Antenna	89		
Multi-Point Vehicle Inspection (MPVI) ...	230		
N			
Navigation			
Destination	91		
Symbols	91		
Using the System	90		
New Vehicle Break-In	120		
Noise Control System	180		
O			
Odometer	58		
Trip	58		
Off-Road			
Recovery	113		
Older Children, Restraints	42		
One-Pedal Driving	127		
OnStar	239		
Additional Information	241		
Overview	240		
OnStar Emergency	241		
OnStar Security	241		
Outlets			
Power	54		
Overhead Console	47		
Overview	84		
Instrument Panel	4		
Owner Checks and Services	231		
P			
Park			
Assist	148		
Shifting Into	123		
Shifting Out of	123		
Parking			
Extended	124		
Passenger			
Compartment Air Filter	108		
Pedestrian Ahead Indicator	63		
Pedestrian Safety Signal	51		
Perchlorate Materials Requirements, California	170		
Phone			
Apple CarPlay and Android Auto	99		
Bluetooth	95, 96		
Plug-In Charging	160		
Port			
USB	89		
Positioning			
Vehicle	93		
Power			
Button	121		

Power (cont'd)		Rear (cont'd)		Retained Accessory Power (RAP)	122
Door Locks	14	Doors	17	Reverse Automatic Braking	149
Indicator Gauge	59	Vision Camera (RVC)	145	Roads	
Mirrors	22	Reclining Seatbacks	27	Driving, Wet	114
Outlets	54	Recognition		Rotation, Tires	198
Protection, Battery	82	Voice	93	S	
Retained Accessory (RAP)	122	Recommended Fluids and Lubricants	232	Safety	
Windows	23	Records		Pedestrian Signal	51
Pregnancy, Using Seat Belts	34	Maintenance	234	Safety Defects Reporting	
Privacy		Regenerative Braking	131	BrightDrop	238
Vehicle Data Recording	239	Remote		Canadian Government	238
Problems with Route Guidance	93	Key	7	U.S. Government	238
Proposition 65 Warning		Key Operation	7	Safety System Check	35
California	1	Vehicle Start	13	Seat Belts	29
Proposition 65 Warning, California	215	Replacement Parts		Buckle To Drive	30
Propulsion		Airbags	42	Care	35
Power Messages	74	Maintenance	233	Extender	35
Publication Ordering Information	237	Replacing		How to Wear Seat Belts Properly	30
R		Airbag System	42	Lap-Shoulder Belt	32
Radiator	175	Seat Belt System Parts after a Crash	35	Reminders	59
Radio		Reporting Safety Defects		Replacing after a Crash	35
AM-FM Radio	87	BrightDrop	238	Use During Pregnancy	34
Frequency Statement	237	Canadian Government	238	Seats	
Reception	88	U.S. Government	238	Adjustment, Front	26
Ready Indicator	65	Requirements		Head Restraints	25
Rear		Electrical Battery Charging	168	Heated Front	28
Cross Traffic Alert (RCTA) System	150	Restraints		Jump	29
		Where to Put	45		

Seats (cont'd)			
Reclining Seatbacks	27		
Security			
Light	65		
OnStar	241		
Vehicle	20		
Vehicle Alarm	20		
Service	108		
Accessories and Modifications	170		
Doing Your Own Work	170		
Electric Parking Brake Light	61		
Maintenance Records	234		
Maintenance, General Information	228		
Vehicle Soon Light	61		
Service Operations and Support with Telecom Relay Services			
BrightDrop	237		
Servicing the Airbag	41		
Settings	101		
Shifting			
Into Park	123		
Out of Park	123		
Side Blind Zone Alert (SBZA)	156		
Signals, Turn and Lane-Change	79		
Sliding Door	16		
Software Updates	87		
Specifications and Capacities	236		
Speedometer	58		
StabiliTrak			
OFF Light	64		
Start Assist, Hill	130		
Start Vehicle, Remote	13		
Starting and Stopping the Vehicle	122		
Status			
Charging Feedback	165		
Steering	112		
Assist, Blind Zone (BZSA)	158		
Column Lock	21		
Heated Wheel	51		
Wheel Adjustment	51		
Wheel Controls	85		
Storage			
Cargo Area	47		
Compartments	46		
Cupholders	47		
Fire Extinguisher	48		
Instrument Panel Areas	46		
Stuck Vehicle	116		
Sun Visors	24		
Surround Vision System	146		
Symbols	3		
Navigation	91		
System			
Airbag	36		
Driver Assistance	144		
Forward Collision Alert (FCA)	151		
System (cont'd)			
Global Positioning	92		
Noise Control	180		
Rear Cross Traffic Alert	150		
Surround Vision	146		
T			
Telecom Relay Services			
BrightDrop Service Operations and Support	237		
Theft-Deterrent Systems	21		
Immobilizer	21		
Time	54		
Tires	189		
All-Season	190		
Buying New Tires	200		
Chains	204		
Changing	205		
Designations	192		
Different Size	202		
Full-Size Spare	215		
If a Tire Goes Flat	204		
Inspection	198		
Pressure	194		
Pressure Light	64		
Pressure Monitor Operation	196		
Pressure Monitor System	195		
Rotation	198		

Tires (cont'd)	
Sidewall Labeling	191
Terminology and Definitions	192
Uniform Tire Quality Grading	202
Wheel Alignment and Tire Balance	203
Wheel Replacement	203
When It Is Time for New Tires	200
Winter	190
Towing	
General Information	168
Traction	
Control System (TCS)/StabiliTrak	
Light	64
Control/Electronic Stability Control	131
Off Light	63
Trademarks and License Agreements	102
Transporting	
a Disabled Vehicle	218
Triangle, Warning	48
Trip Odometer	58
Turn and Lane-Change Signals	79
U	
Underhood	
Compartment Fuse Block	183
Compartment Overview	174
Uniform Tire Quality Grading	202

Updates	
Software	87
USB Port	89
Using	
Infotainment System	85
Navigation System	90
This Manual	2
Utility Interruption of Charging	167

V

Vehicle

Ahead Indicator	63
Alarm System	20
Automatic Hold	130
Automatic Hold Light	62
Canadian Owners	2
Control	112
Data Recording and Privacy	239
Identification Number (VIN)	235
Load Limits	117
Messages	74
Positioning	93
Ready Light	65
Remote Start	13
Security	20
Service Soon Light	61
Speed Messages	75
Starting and Stopping	122

Vehicle (cont'd)

Symbols	3
Vehicle Care	
Tire Pressure	194
Vehicle Security	
Steering Column Lock	21
Ventilation, Air	107
Visors	24
Voice Recognition	93
Voltage Devices and Wiring	181

W

Warning

Brake System Light	61
Caution and Danger	2
Hazard Flashers	79
Lights, Gauges, and Indicators	55
Triangle	48
Washer Fluid	175
Wheels	
Alignment and Tire Balance	203
Different Size	202
Replacement	203
When It Is Time for New Tires	200
When to Charge	160
Where to Put the Restraint	45
Windows	23
Power	23

Windshield	
Replacement	181
Wiper/Washer	52
Winter	
Driving	115
Tires	190
Wiper	
Blade Replacement	180
Wiring, High Voltage Devices	181



gobrightdrop.com



86530609 A

